

RADIODETECTION 

6100-Cu

Multifunction Phone Network Analyser and Copper Tester

Operation manual

90/6100-CU-OPMAN-ENG/01

Contents

Section 1 Preface	5	8.1 Result Manager.....	49
1.1 Before you begin.....	5	8.2 Results Summary.....	49
1.2 Important notices.....	5	8.3 Result Manager Menu.....	49
1.3 Training.....	5	8.4 Upload.....	51
Section 2 Introduction	6	8.5 Export.....	52
2.1 About this manual.....	6	8.6 Delete.....	53
Additional documentation.....	6	Section 9 Multimeter Tests	54
2.2 About the 6100-Cu.....	6	9.1 Multimeter Main Page.....	54
2.3 Product description.....	6	9.2 Voltage.....	55
2.4 Key Features and Benefits.....	6	9.3 Current.....	57
2.5 Typical Applications.....	6	9.4 Resistance.....	59
Section 3 Using the 6100-Cu	7	9.5 Resistive Balance.....	61
3.1 Cable Connections.....	8	9.6 Isolation.....	63
3.2 Technical specifications.....	8	9.7 Capacitance/Opens.....	65
Section 4 Safety Information	9	9.8 Station Ground.....	67
4.1 Equipment Ratings.....	9	9.9 Stressed Balance.....	69
Section 5 Getting Started with the 6100-Cu	10	Section 10 SmartR Features	72
5.1 Turning the Unit On/Off.....	10	10.1 Pair Detective.....	72
5.2 Using Menus and Keypad.....	10	10.2 Pair Detective Result Details.....	77
5.3 Keypad.....	11	10.3 FaultMapper.....	77
5.4 Using Screenshot Capture.....	11	Section 11 Noise Tests	82
Section 6 Setting Up the 6100-Cu	12	11.1 Noise Tests Main Page.....	82
6.1 Home.....	12	11.2 VF Noise.....	82
6.2 System Settings.....	12	11.3 Power Influence.....	84
6.3 Display and Language.....	12	11.4 VF Impulse Noise.....	85
6.4 Remote Display.....	13	11.5 WB PSD Noise.....	87
6.5 Date and Time.....	14	11.6 WB Impulse Noise.....	90
6.6 Battery Info.....	15	11.7 NEXT.....	92
6.7 Software Options.....	16	Section 12 Frequency Tests	98
6.8 Information.....	16	12.1 Frequency Tests Main Page.....	98
6.9 Upload Setup.....	17	12.2 VF/AC Balance.....	98
6.10 Wi-Fi Test.....	20	12.3 WB Balance.....	101
6.11 Comms Setup.....	21	12.4 WB Attenuation.....	104
Section 7 Setting Up Copper Tests	23	12.5 Return Loss.....	107
7.1 Copper Test Main Menu.....	23	12.6 Load Coils.....	110
7.2 Test Configuration.....	23	12.7 Locator Tone.....	112
7.3 Setup.....	27	12.8 TX/RX Tone.....	113
7.4 Phone Book.....	28	12.9 RX Tone with FED.....	114
7.5 Dialer Function.....	31	Section 13 TDR	118
7.6 Cable Book.....	34	13.1 Continuous.....	118
7.7 Application Settings.....	38	13.2 xTalk TDR.....	123
7.8 Test Lead Compensation.....	42	13.3 Cable Setup.....	125
7.9 FED Control.....	43	13.4 Load Trace.....	126
7.10 Saving Results.....	47	13.5 Result Details.....	126
Section 8 Reading Saved Copper Test Results	49	13.6 TDR Profile Details.....	128
		Section 14 RFL	129
		14.1 Single Pair.....	129
		14.2 Separate Good Pair.....	130
		14.3 K-Test.....	131
		14.4 RFL Cable Setup.....	133
		14.5 Result Manager.....	133
		14.6 Result Details.....	134

Section 15 Copper Auto Tests	136
15.1 Menu.....	136
15.2 POTS Auto Test.....	136
15.3 User Auto Test.....	138
15.4 Result Details.....	146
15.5 Profile Details.....	146
Section 16 Maintenance.....	150
16.1 General Maintenance.....	150
16.2 Recalibrating the Unit.....	150
16.3 Battery	150
16.4 Recycling and Disposal.....	151
Section 17 Troubleshooting	153
17.1 Solving Common Problems.....	153
17.2 LED Statuses.....	154
17.3 Transportation.....	154
Section 18 Software License Agreement	
(“Agreement”)	155
18.1 DEFINITIONS.....	155
18.2 PROPRIETARY RIGHTS.....	156
18.3 LICENSE GRANT	156
18.4 LICENSE RESTRICTIONS	157
18.5 RESERVED RIGHTS.....	157
18.6 COOKIE AND PRIVACY POLICY	158
18.7 AUDIT.....	158
18.8 SUPPORT	158
18.9 CONFIDENTIAL INFORMATION.....	158
18.10 LIMITED WARRANTY AND EXCLUSIVE REMEDY	159
18.11 DISCLAIMER.....	159
18.12 LIMITATION OF LIABILITY.....	159
18.13 TERM AND TERMINATION.....	160
18.14 GENERAL.....	160

Section 1 Preface

1.1 Before you begin

Thank you for your interest in Radiodetection's 6100-Cu Multifunction Phone Network Analyzer and Copper Tester.

Please read this user manual in its entirety before attempting to use the 6100-Cu system as it contains many important safety notices and warnings.

Radiodetection products, including this manual, are under continuous development. The information contained within is accurate at the time of publication; however, the 6100-Cu, this manual and all its contents are subject to change.

Radiodetection Limited reserves the right to modify the product without notice and some product changes may have taken place after this user manual was published.

Contact your local Radiodetection dealer or visit www.radiodetection.com for the latest information about the 6100 product family, including this manual.

1.2 Important notices

Read this manual in its entirety before attempting to operate the 6100-Cu. Note all safety notices in the preface and throughout this manual.

Ensure that you have read and understood the safety notices in Section 4 [Safety Information](#).

 **WARNING:** *Failure to comply with safety warnings can cause serious injury or death.*

CAUTION: *Failure to comply with safety cautions can result in damage to equipment or property.*

This equipment shall be used only by qualified and trained personnel, and only after fully reading this Operation Manual.

 **WARNING:** *Direct connection to live conductors is POTENTIALLY LETHAL. Direct connections to live conductors should be attempted by fully qualified personnel only using the relevant products that allow connections to energized lines.*

You are responsible for determining whether the conditions are suitable for using this device. Always carry out a risk assessment of the site to be inspected.

Follow your company and national safety procedures and or requirements when operating this equipment in any environment or workplace. If you are unsure what

policies or procedures apply, contact your company or site's occupational health and safety officer or your local government for more information.

Do not use this equipment if you suspect that any component or accessory is damaged or faulty.

Use authorized accessories only. Incompatible accessories may damage the equipment or give inaccurate readings.

Keep this equipment clean and arrange for regular services with an authorized Radiodetection service center. More information can be found in the Appendix or from your local Radiodetection representative.

Headphone use: you need to remain alert to traffic and other hazards that are normally heard outdoors. Always turn the volume down before plugging headphones into an audio source and use only the minimum level, necessary to take your measurements. Excessive exposure to loud sounds can cause hearing damage.

Do not attempt to open or dismantle any part of this equipment unless directed specifically by this manual. Doing so may render the equipment faulty and may void the manufacturer's warranty.

You are responsible for determining whether you consider the measurement results to be valid and for any conclusions that are reached or any measures that are taken as a result thereof. Radiodetection can neither guarantee the validity of any measuring results nor can we accept liability for any such results. We are on no account able to accept liability for any damage which may be caused as a consequence of the use of these results. Please see the Standard Warranty Terms enclosed with the product for further information.

1.3 Training

Radiodetection provides training services for most Radiodetection products. Our qualified instructors will train equipment operators or other personnel at your preferred location or at a Radiodetection location.

For more information go to www.radiodetection.com or contact your local Radiodetection representative.

Section 2 Introduction

2.1 About this manual

This manual provides copper network installation and repair professionals with comprehensive operating instructions for the 6100-Cu test system. Before operating the 6100-Cu system it is very important that you read this manual in its entirety, noting all safety warnings, cautions and procedures.

Additional documentation

The full product specification and related manuals are available to download from

www.radiodetection.com.

2.2 About the 6100-Cu

The 6100-Cu is a handheld device designed to qualify and troubleshoot the copper-loop plant by using pass/fail-driven automated functionalities.

The unit also verifies the location of faults during the installation and repair of voice and DSL circuits.

For more information, including available accessories, please visit

www.radiodetection.com

2.3 Product description

The 6100-Cu Test Set is housed in an aluminum enclosure with rubber over mold, which makes it ideal for field use. Its display is a back-lit LCD featuring 480 x 800 resolution. A membrane keypad mounted on the face of the unit features a 14-button keypad used to operate the test set. An external keyboard and mouse can also be used.

2.4 Key Features and Benefits

- User-defined automatic testing
- Single-ended copper testing – no remote device required
- Color display with graphical analysis
- Battery powered
- Rugged and weatherproof handheld unit
- Touchscreen with stylus
- Compatible with Teletch TS125 or Viavi UFED IIB Remote Far End Device (FED) for remote control circuit change

2.5 Typical Applications

- Automatic Pair Quality Test toward remote test head or far end device (FED)
- Multimeter tests
- Noise tests including power influence and PSD
- Frequency tests including balance, load coils, and tracing tone
- Fault location tests including TDR and RFL
- SmartR features including Pair Detective and FaultMapper
- Configurable pass/fail results for automated testing

Section 3 Using the 6100-Cu

The 6100-Cu is tested for IEC IP54 compliance which means that it is not affected by dust or water splashing against the enclosure from any direction. This protection is only valid when both side doors are properly closed. If the equipment is used in a manner not specified by the manufacturer, the protection provided by the equipment may be impaired.

The 6100-Cu is equipped with a series of interfaces:

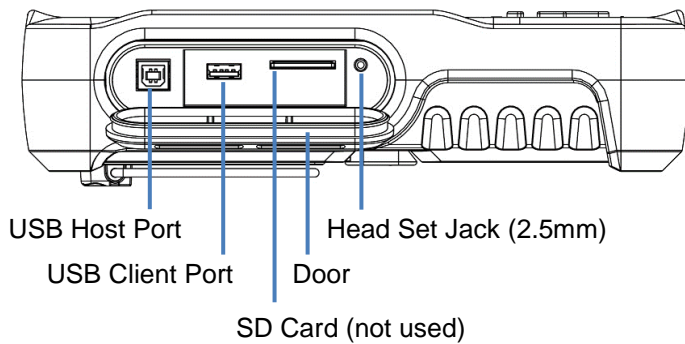

Fig. 3.1: 6100-Cu connections – left view

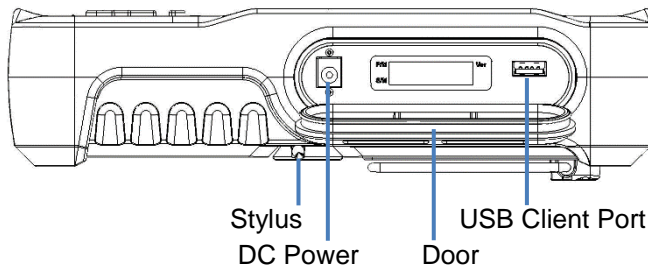

Fig. 3.2: 6100-Cu connections – right view

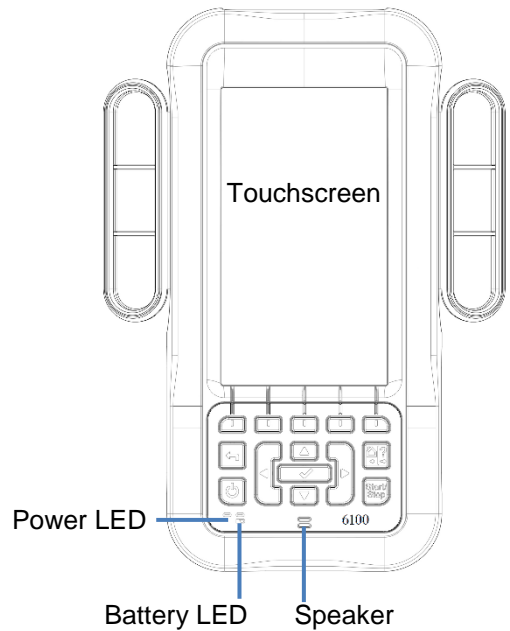

Fig. 3.3: 6100-Cu connections – top view

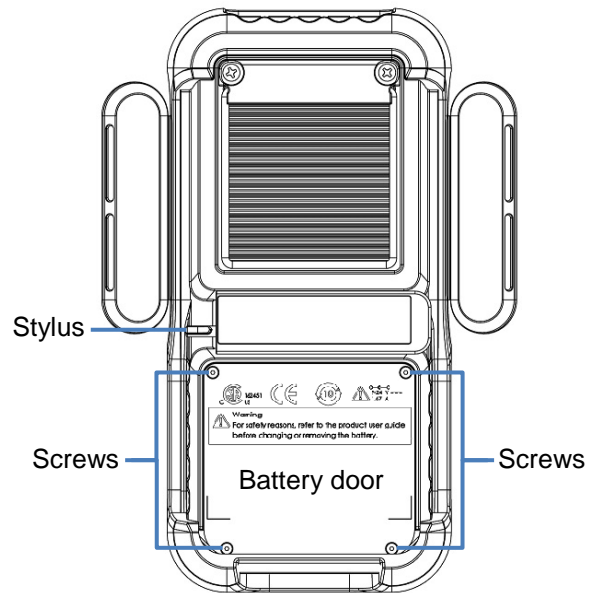

Fig. 3.4: 6100-Cu connections – back view

Note: The 6100-Cu enclosure may become warm during normal use.

3.1 Cable Connections

The graphics below show the connectors on the 6100-Cu device.

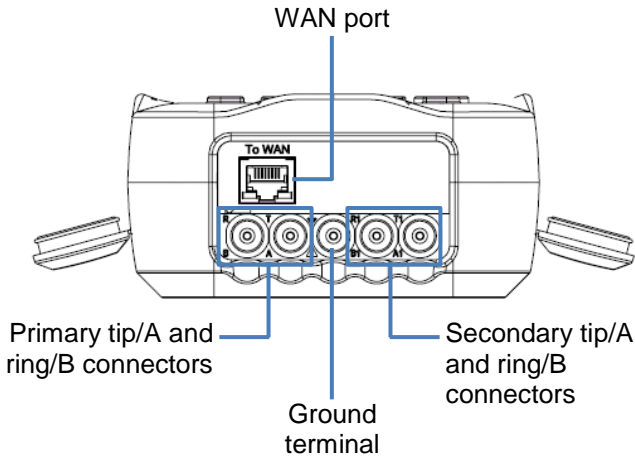

Fig. 3.5: 6100-Cu connections – end view

Note: When connecting a DSL cable to the WAN port, use the RJ-45 plug end of the cable provided with the unit. There is a 1500 V maximum transient voltage on telecom ports. Basic insulation is needed for external telecom circuits.



WARNING! These connections are intended for the express purpose of electrical testing of common telephone line conductors, within the ranges specified in the Technical Specifications found on the Radiodetection Web site. The device is not intended to be used on telephone lines having voltages greater than 280 VAC or 400 VDC, and it is also not intended to be used on power distribution circuits.

CAUTION: The unit is protected against damage caused by fault voltages that may be present on lines under test. Do not connect the unit if the maximum expected fault voltage is greater than 500 volts.

3.2 Technical specifications

Please see the separate Technical Specification document, available at www.radiodetection.com

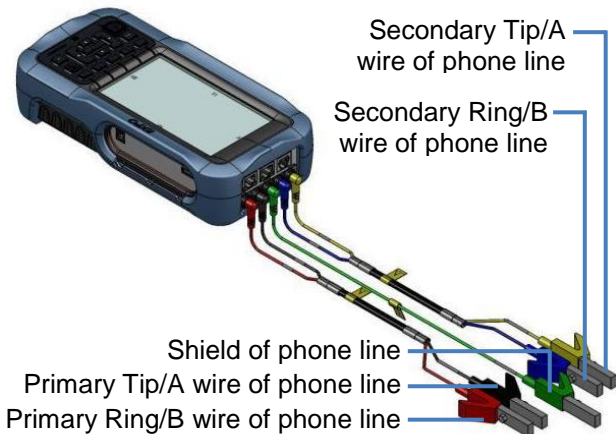

Fig. 3.6: 6100-Cu connection identification



WARNING! A 50 to 500 V limited power source may be present on connector T/R/G (A/B/E), T1/R1/G (A1/B1/E) when the unit is testing isolation resistance. Use with caution.

Section 4 Safety Information

WARNING. The use of controls, adjustments and procedures other than those specified herein may result in exposure to hazardous situations or impair the protection provided by this unit.

WARNING. If the equipment is used in a manner not specified by the manufacturer, the protection provided by the equipment may be impaired.

WARNING. Use only accessories designed for your unit and approved by Radiodetection. For a complete list of accessories available for your unit, refer to its technical specifications or contact Radiodetection.

IMPORTANT

When you see the following symbol  on your unit, make sure that you refer to the instructions provided in your user documentation. Ensure that you understand and meet the required conditions before using your product.

IMPORTANT

Other safety instructions relevant for your product are located throughout this documentation, depending on the action to perform. Make sure you read them carefully when they apply to your situation.

Electrical Safety Information

The AC adapter/charger provided with this unit is specifically designed to work with your 6100-Cu.

WARNING.

- Only use the AC/DC adapter/charger indoors.
- Only use with a Class II AC/DC adapter, power limited output.
- On the AC/DC adapter, replacing detachable mains supply cords with inadequately rated cords, may result in overheating of the cord and create a fire risk.
- The adapter shall have the appropriate safety mark (e.g. UL, CSA, TUV, CE, etc.) that is acceptable to the authorities in the country where the equipment is to be used.

CAUTION. When using the 6100-Cu while connected to the AC/DC adapter/charger, make sure you do not position the equipment so that it is difficult to disconnect the adapter/charger from the AC mains.

WARNING. Only use accessories that meet Radiodetection specifications.

4.1 Equipment Ratings

Temperature	
Operation	0 °C to 40 °C (32 °F to 104 °F)
Storage	−40 °C to 70 °C (−40 °F to 158 °F)
Relative humidity ^a	
6100-Cu	≤ 95 % non-condensing
AC adapter	0 % to 80 % non-condensing
Maximum operating altitude	3000 m (9843 ft)
Pollution degree	2 (when plugged to AC mains) ^b 3 (when operated from batteries) ^c
Overvoltage category	II
Input power ^d	
6100-Cu	9-24 V; 18 W; 1.67 A
AC adapter	100 - 240 V; 50/60 Hz; 0.7 A

- Measured in 0 °C to 31 °C (32 °F to 87.8 °F) range, decreasing linearly to 50 % at 40 °C (104 °F).
- For indoor use only.
- Equipment is normally protected against exposure to direct sunlight, precipitations and full wind pressure.
- Not exceeding ± 10 % of the nominal voltage.

Section 5 Getting Started with the 6100-Cu

5.1 Turning the Unit On/Off

When you turn the unit on, you may use it immediately under normal conditions. When the unit is turned off, it keeps the following parameters in its internal memory:

- Setup including application settings, phone and cable books, and test lead characteristics.
- Profiles consisting of:
 - Test parameters
 - User-defined thresholds

*Note: Save the current profile before turning the unit off, or else any changes will be lost. See **To save a profile, use one of the following function keys: for more information.***

- Regional, LCD, and energy-saving settings
- Test results saved internally vs. USB

There are two ways to turn off the 6100-Cu:

- *Suspend*: the next time you turn your unit on, you will quickly return to your work environment.
- *Shutdown*: completely cuts power to the unit; the unit will perform a complete restart routine the next time you use it. You should perform a shutdown if you do not intend to use your unit for a few hours or more.

To turn the unit on:

Press  to start. The unit initializes for a few seconds and displays the **Home** pane.

To enter suspend mode:

Press  for about 2 seconds. The 6100-Cu will stay in suspend mode for 2 hours. After which it will automatically shut down. This prevents complete battery discharge and ensures maximum battery performance.

To perform a shutdown:

Hold down  for at least 4 seconds. The shutdown process starts.



Note: In both previous cases, if the power adapter is connected, the 6100-Cu will simulate either a fake suspend or fake shutdown in order to facilitate the charger.

*Note: If you hold  down for 12 seconds or more, the 6100-Cu may reset the date and time to incorrect values. Once the unit is powered back on, an Invalid Date and Time dialogue box will pop up displaying **The unit date and time are probably invalid. (1/1/2006 12:00:25 PM)**. Please update the date and time in **Date and Time** to ensure the delivery of all the functionality the unit has to offer.*

5.2 Using Menus and Keypad

You can access various tools from the keypad or menu. Menu options may differ depending on your unit configuration.

Home menu is where you can access **Copper** tests or **System Settings**. Each test has a sub menu.

- To navigate through the items, use the arrow keys.
- To confirm a choice or enter a menu, press .
- To cancel an action or test, or return to the previous item or pane, press .
- Press  once to return to the Main test menu or twice to return to the Home page.

Note: Pressing  while a test is running will also stop the test and return to the main menu screen.

Note: You can also select an option directly by pressing the function keys corresponding to the on-screen buttons at the bottom of the screen.

5.3 Keypad

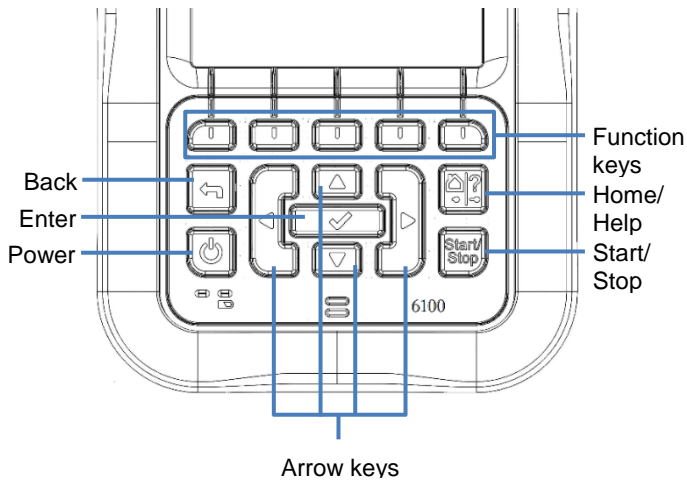

- Power button on the lower left side of the unit is used to power the unit on and off.
- Arrow Keys navigate the screen to access and modify parameters.
- Function Keys activate the corresponding on-screen function button.
- Home button brings you to the **Copper Main** page of the 6100-Cu or to the **Home** page.

5.4 Using Screenshot Capture

Using the Home/Help button, you can take a screenshot of the current page display. If screenshots are Enabled, you will have to select No in the popup message before accessing the onboard help. (See below.)

Screenshot Capture

To take a screenshot:

Press and hold the Home/Help button to capture the current page and save it with filename screenshot_ddmmyyyy_hhmmss where ddmmyyyy is 2-digit day, 2-digit month, 4-digit year; and hhmmss is 2-digit hour, 2-digit minute, and 2-digit second.

*Note: The date and time value format is dependent on the format selected in **System Settings \ Date and Time**.*

- Screenshots can be Enabled or Disabled from the System Settings \ Display and Language page.

- If **Enabled**, press and hold the **?** key to capture a screenshot on any page.
- A popup message is displayed saying **Screenshot captured, Press “Yes” to save or “No” to continue to Help**. Pressing **No** will also discard the screenshot.

*Note: If you selected USB as the screenshot file location and no USB is connected to the 6100-Cu, the following popup message is displayed: **Screenshot not saved, Insert USB and press “Yes” to save it or press “No” to continue to Help**.*

- Disabling **Enable Screenshots** will take you to the onboard help page when pressing and holding the **?** key, as previously described.

Onboard Help

Onboard help is available at any time. Most test operations pause while you view help, but will resume automatically when you exit help.

To access help about the current function at any time:

Press and hold the **?** key.

Section 6 Setting Up the 6100-Cu

6.1 Home

Home presents the main menu page which allows you to navigate between **Copper Test** and **System Settings** using the left/right arrow keys on the keypad.

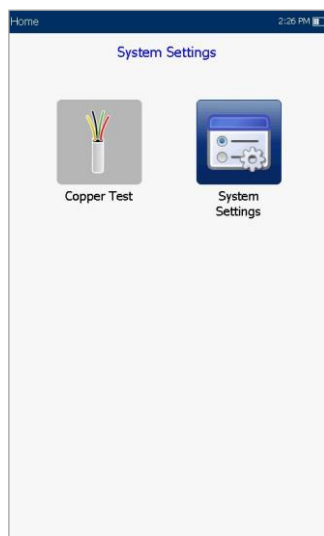

Press  to bring up the sub-menu of the selected icon:

- **Copper Test** opens the **Copper Main** menu displaying the copper qualification testing applications.
- **System Settings** allow you to set the parameters of the unit such as language, date and time, and battery info. You can also view installed options, and software and hardware revision information. Plus, **System Settings** provides access to **Upload Setup**.

6.2 System Settings

System Settings presents a menu of items to setup the unit.

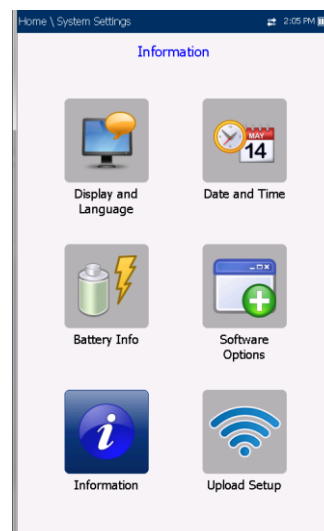

- **Display and Language** provides the setup for backlight, information on the title bar, language choice, and **Touchscreen Calibration**.
- **Date and Time** sets the date, time and format.
- **Battery Info** displays the battery status and measurements, and allows you to set the power schemes.
- **Software Options** allow you to enable/disable purchased feature options.
- **Information** displays information **About** Radiodetection and unit details pertaining to hardware/software/ product info.
- **Upload Setup** allows you to enable and select an upload method using the following function keys:
 - **Upload Enable**
 - **FTP Setup**
 - **Wi-Fi Setup**
 - **Ethernet Setup**

To navigate between the system settings:

1. Press the up/down left/right arrow keys on the keypad to select an icon.
2. Press  to confirm your selection.





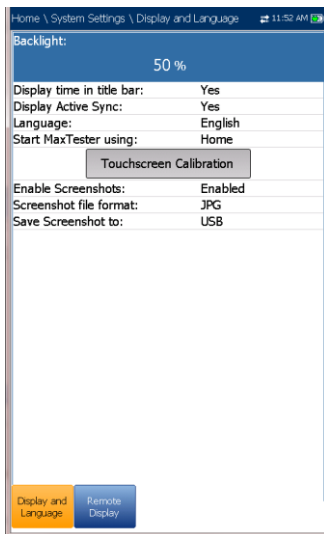

6.3 Display and Language

To fit your work environment, you may adjust the LCD brightness, display the time and ActiveSync, and change the display language. Plus, you can **Enable Screenshots** which uses the Home/Help button. The values are kept in memory when you turn the unit off.



*Note: The LCD **Backlight** consumes battery power; more brightness results in more power consumption.*

To adjust the display settings:

1. From , select **System Settings**, and then **Display and Language**.
2. Use the up/down arrow keys to select the setting to change.
3. Press to  select.
 - By using the up/down arrow keys, you can switch between preset brightness levels in the **Backlight** item. Press  to confirm.
 - To display the time and ActiveSync in the title bar, enable the item.
 - Press  after your selection to confirm.
 - Use the up/down arrow keys to navigate between the available languages, then press  to select. You will be prompted to restart your unit.
 - To set which Home page the unit defaults to when pressing , highlight **Start 6100-Cu using:** and select from the list.
 - **Touchscreen Calibration.** To calibrate the touchscreen, press/tap/click the button to open a popup window and select **Yes** or **No**. This screen will automatically display during power up, if calibration was never conducted and the data file is not available in memory.
 - To **Enable Screenshots**, select **Enabled** (default), then the **Screenshot file format** in

either **JPG** (default) or **GIF**, and where you would like to **Save Screenshot to:** **USB** (default) or **FTP**.

- If **USB**, the image is saved to a directory called \\6100\Screenshots on the USB memory device. If the directory does not exist, create it on the root directory of the USB memory device.

Note: If you selected USB as the screenshot file location and no USB is connected to the 6100-Cu, the following popup message is displayed:

Screenshot not saved, Insert USB and press "Yes" to save it or press "No" to continue to Help.

- If **FTP**, the image is saved locally to \\DATA\6100\Copper\UploadResults.

From **Result Manager\Upload\Upload Location**, select **FTP** to enable uploading screenshot images to the FTP server. If you select **USB** as the **Upload Location**, the image is uploaded to Removable Disk\6100\Screenshots.

*Note: **FTP** is available only if you have the **FTP Result Upload** option listed in **System Settings\Software Options\Platform Options**.*

6.4 Remote Display

The Remote Display function allows you to connect the 6100-Cu to your computer remotely, using PC TightVNC or RealVNC client application, and a Bluetooth or USB connection.

- **Enable Remote Display** button starts the **Remote Display** connection. Once the connection is setup successfully and the remote display server starts, the button changes to **Stop Remote Display** until the connection is dropped.
- **Connect to Device** allows you to select a Bluetooth device that has been paired successfully or a **USB Connection**. A connection icon is displayed in the menu bar if the setup is successful. If you select **None**, then the **Enable Remote Display** button is disabled.

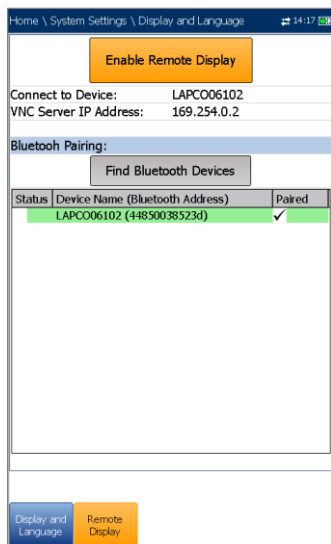

*Note: The **USB Connection** for **Remote Display** uses **RNDIS** protocol and the **ActiveSync** will not be functional when this **USB** connection is active.*

- **VNC Server IP address** displays one of the following server IP addresses:
 - for a **USB Connection**, 169.254.0.1
 - for a Bluetooth connection, 169.254.0.2
 - for **None**, N/A
- **Bluetooth Pairing**
 - **Find Bluetooth Devices** button searches for and lists all discoverable Bluetooth devices. The list also displays all the device names that were previously paired with your 6100-Cu, whether or not a Bluetooth signal is currently present.
 - **Status** displays a Bluetooth symbol if the device is connected.
- **Device Name (Bluetooth Address)** displays the name of the device and its Bluetooth address.
- A third, right-hand column displays a checkmark if the device is **Paired**.

Note: Use only a Radiodetection certified Bluetooth dongle.

To initiate remote display:

1. Connect the Bluetooth Dongle or **USB Connection** to a USB port on the 6100-Cu.

2. Select the **Connect to Device** and press the up arrow key to highlight and press the **Enable Remote Display** button.

OR

3. Press the down arrow key to highlight and press the **Find Bluetooth Devices** button to search for available Bluetooth devices.
4. Press the down arrow key to highlight the list box and press **✓** to get into the list.
5. In the list, press the up/down arrows to select a device to pair.
6. Follow the instructions in the pop-up dialog boxes. Only one device can be paired at a time in the 6100-Cu.
7. Once you have connected to your device, press **←** to come out of the list.
8. Return to step #2 above to select your Bluetooth device and establish the VNC connection.

6.5 Date and Time



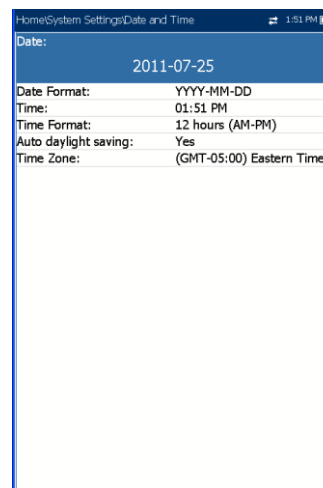

When saving results, the unit also saves the corresponding **Date** and **Time**.



- Date allows you to enter the date according to the following formats:
 - yyyy-mm-dd
 - dd-mm-yyyy
 - mm-dd-yyyy
- The **Time Format** can be set according to the 12- or 24-hour formats.

- You can also modify the **Time Zone** and enable an option so that your unit automatically adjusts the time for the daylight saving period.

To set the date and time:

- Press , select **System Settings**, and then **Date and Time**.
- Use the up/down arrow keys to select any of the date or time settings.
- Press ** to enable the modification controls.
 - For the **Date** and **Time**, an edit screen is displayed with descriptive function keys.
 - Use the arrow keys to modify the number values, then press to confirm the change and go back to the previous screen.
 - If **12 hours (AM-PM)** is selected, when setting the **Time** in the edit screen, toggle the **AM/PM** function key for the desired period of the day. Press  to go back to the previous screen without saving the new value.
 - For the **Time Format**, **Auto daylight saving** and **Time Zone** values, use the arrow keys to select the desired value, then press  to confirm the change.

6.6 Battery Info

You can set your unit to automatically switch to suspend mode independently for the battery or DC power modes.

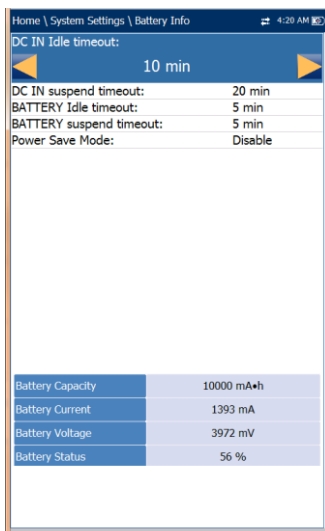

Home \ System Settings \ Battery Info	
DC IN Idle timeout:	10 min
DC IN suspend timeout:	20 min
BATTERY Idle timeout:	5 min
BATTERY suspend timeout:	5 min
Power Save Mode:	Disable
Battery Capacity	10000 mA•h
Battery Current	1393 mA
Battery Voltage	3972 mV
Battery Status	56 %

This is useful for example if you want to save battery power but do not want to be hindered by unwanted switches between modes when using DC power.

- Power off completely shuts down the unit's power.
- Power suspend puts the unit in sleep mode; you can wake up the system by pressing .

*Note: If you hold down  for 12 seconds or more, the 6100-Cu may reset the date and time to incorrect values. Once the unit is powered back on, an **Invalid Date and Time** dialog box will pop up displaying **The unit date and time are probably invalid. (1/1/2006 12:00:25 PM)**. Please update the date and time in **System Settings/Date and Time** to ensure the delivery of all the functionality the unit has to offer.*



- DC IN/BATTERY Idle timeout** allows you to set the time duration for the unit to idle (no keys pressed or test being run) before turning off the LCD.
- DC IN/BATTERY suspend timeout** allows you to set the time duration for the unit to enter sleep mode.

*Note: Setting the **DC IN suspend timeout** to the lowest value and not to **Never** ensures the unit enters suspend mode while the charger is connected. Battery charging time is quickest when the unit is in suspend mode.*

- Power Save Mode** is either **Disable/Enable**. When enabled, **BATTERY Idle timeout** and **BATTERY suspend timeout** are set to **5 min**, **Backlight** to **50 %**, and **Modem Power OFF** (including the unit) to **Immediately**. The selections are limited and the following warning message will popup:
 - Power Save mode is enabled. High Voltage Monitoring is active only while the test is in progress.
 - The Default power scheme settings are:
 - LCD backlight turns off after system idles (no keys pressed) for 10 min.
 - Unit switches to suspend mode after timeout: 10 min.
 - Power Save Mode** is **Disable** requiring you to go to this page to see what will be changed before enabling it.

The chart displays the following battery measurements: capacity, current, and voltage. **Battery Status** indicates the current power level, as a percentage, for the battery.

To change the power scheme settings:

1. Press , select **System Settings**, and then **Battery Info**.
2. Under **DC IN** or **BATTERY**, use the arrow keys to select **Idle/suspend timeout** modes. Press  to view the list of available choices or use the left/right arrow keys.
3. Select a new value, then press  to confirm the choice. Repeat for the other modes as needed.

6.7 Software Options

To activate a newly purchased option key on your 6100-Cu, please contact Radiodetection. The unit may require returning to Radiodetection.

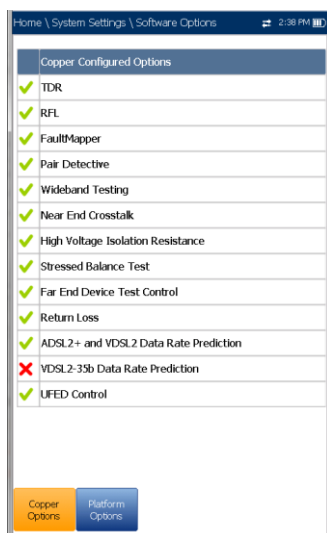

Copper Options

This screen lists all the **Copper Configured Options** that are present on the unit. Possible options are as follow:

- TDR
- RFL
- FaultMapper
- Pair Detective
- Wideband Testing
- Near End Crosstalk
- High Voltage Isolation Resistance
- Stressed Balance Test
- Far End Device Test Control

- Return Loss
- ADSL+ and VDSL2 Data Rate Prediction
- VDSL2-35b Data Rate Prediction
- UFED Control

Platform Options

This screen lists all the Platform Configured Options which are present on the unit.

Possible options are:

- **FTP Result Upload**
- **Touchscreen Support** (always enabled)

6.8 Information

About Radiodetection

The **About** tab contains contact information should you require technical assistance.



6100-Cu Information

The **Information** tab displays information about the product, software, and memory installed on the device.

The page also identifies hardware information.

To view the complete version numbers of the software installed on the device:

1. Press the **Information** tab again.
2. Press the tab again to return to the original value.

Product Information	
Product Name	6100
Model	MAX-610
Serial Number	1317351
Product Status	Production
Software Information	
System Image	3.10
FPGA	NA
USB microcontroller	2.6
Analog microcontroller	NA
Linux Version	N/A
Bonding ADSL AnnexA+VDSL2	N/A
Single ADSL AnnexA+VDSL2.Phy	N/A
Single ADSL annexB+VDSL2.Phy	N/A
Memory Information	
Total RAM	256 MB
Available Flash for user data	6487.00 MB
Hardware Information	
CQ Board Revision	L

Note: Only channels 1 to 11 are supported on the Wi-Fi hotspot/router.

A Wi-Fi symbol, in the top right-hand corner of the navigation bar, identifies whether or not a connection is present. The Wi-Fi status is indicated as follows:

- Green icon indicates that the 6100-Cu is connected with a Wi-Fi hotspot.



- Yellow icon indicates that the Wi-Fi dongle is powered up and ok, but that the 6100-Cu is not connected to any Wi-Fi hotspot.

- Red icon indicates a problem with the Wi-Fi (dongle not attached, etc.).



6.9 Upload Setup

Upload Enable

The **Upload Enable** function allows you to upload your test result files (**FTP Result Upload** option must be enabled.)



- **Ethernet** is the default upload and if selected, displays an Ethernet icon in the top right-hand corner of the navigation bar. It identifies whether or not a connection is present displaying a green or yellow icon similar to the Wi-Fi symbol described above.
- **Disable Upload** option disables uploading your files via Wi-Fi or Ethernet. You can export results to a USB memory device.



The **DSL In-band Upload** method supports **DSL** or **Ethernet**, and can be set to either **Enable** or **Disable**.

The **Out-band Upload Method** allows you to use one of the following methods:

Wi-Fi allows you to upload files from the 6100-Cu via a Wi-Fi hotspot/router and is available for the following results pages:

- Copper User Auto Test from Upload/Save Result tab
- Copper User Auto Test from Result Manager/Summary/Upload
- All Copper results from **Result Manager/Upload**

FTP Setup

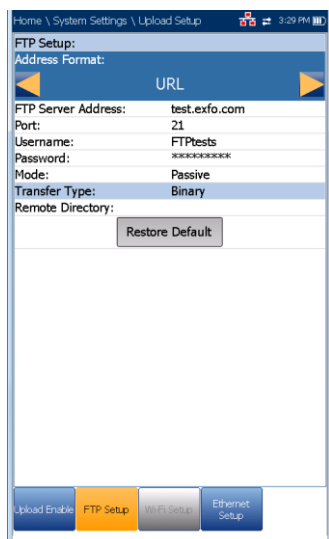

The **FTP Setup** function allows you to configure the file transfer information using the following:

- **Address Format** allows you to select the FTP server address type:
 - IP Address
 - URL
- **FTP Server Address** allows you to set either the IP Address or URL.
- **Port** is a fixed numeric value for the signaling port used to establish an IP network session.
- **Username/Password** is your login ID and password.
- **Mode** is either **Active** or **Passive** for the file transfer mode.
- **Transfer Type** is set to **Binary**, transferring files as a binary stream of data.
- **Remote Directory** can be used to specify the file upload directory on the FTP server, for example, dir1/dir2. If this field is left empty, the FTP upload will save the result file at root directory on FTP server.
- **Restore Default** button allows you to reset the entries to their defaults.

To configure the setup options:

1. Press the up/down arrows to select the desired parameter.
2. Press the left/right arrow keys to view and select the options.

OR

3. Press  on a value to open a list box of options or the alphanumeric editor screen and

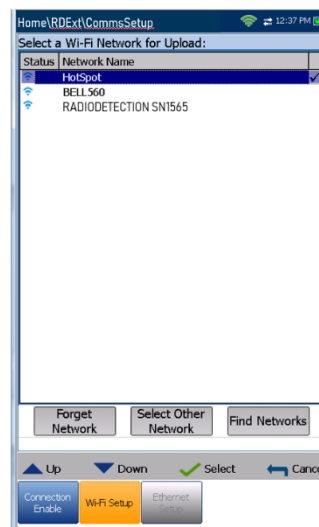

use the navigation keys to scroll through.

4. Press  to confirm the value.

Wi-Fi Setup

The **Wi-Fi Setup** pages allows you to connect your 6100-Cu to a Wi-Fi network.

- **Select a Wi-Fi Network for Upload** lists the available secure Wi-Fi networks in range and presently connected. (Unsecured Wi-Fi networks are not supported.) The last three networks that were connected are also listed, whether or not they are presently connected to the 6100-Cu.





Note: If you select a network from the list of previously selected networks (last 3), the 6100-Cu will try to join that network using the credentials saved for the selected network.

- **Status** displays a Wi-Fi symbol if the device is connected, and is dynamically updated with the present connectivity state of the networks.
- **Network Name** is the Wi-Fi network name.
- A third, right-hand column displays a checkmark indicating the network selected for upload.
- **Forget Network** button removes a previously joined network from the list.

- **Select Other Network** button opens a new page allowing you to search for a specific network.
- **Find Networks** button searches for available networks.

Note: Only Wi-Fi channels 1-11 are supported.

To connect your 6100-Cu to a Wi-Fi network:

1. Press the down arrow key to highlight the list box and press  to get into the list.
2. In the list, press the up/down arrows to select the desired network.
3. Press  to confirm a network and open the alphanumeric editor screen to enter your Password.
4. Press  to come out of the list.
5. Press the down and left/right arrow keys to highlight the network buttons and press .

Select Network

The **Select Network** page allows you to search for a specific Wi-Fi network.





- **Network Name** opens the alphanumeric editor screen allowing you to enter the name of the desired Wi-Fi network.
- **Security** lists the following wireless security protocols:
 - WEP (Wired Equivalent Privacy)
 - WPA (Wi-Fi Protected Access)
 - WPA2 (Wi-Fi Protected Access version 2)

Note: When using WPA encryption, some specific routers may have performance issues with the supplied Wi-Fi dongle. In this case, please use WPA2 encryption.

- **Password** opens the alphanumeric editor screen allowing you to enter the desired Wi-Fi network's password. Join function key replaces Done on the editor screen.
- **Join** function key allows your 6100-Cu to connect to the other network and it becomes the selected/preferred upload network.

To configure the other network parameters:

1. Press the up/down arrow keys to highlight the desired parameter.
 2. Press the left/right arrow keys to view and select the options.
- OR
3. Press  on a value to open a list box of options or the alphanumeric editor screen and use the navigation keys to scroll through.
 4. Press  to confirm the value.
 5. Press the **Join** function key to connect to the other Wi-Fi network.

Ethernet Setup

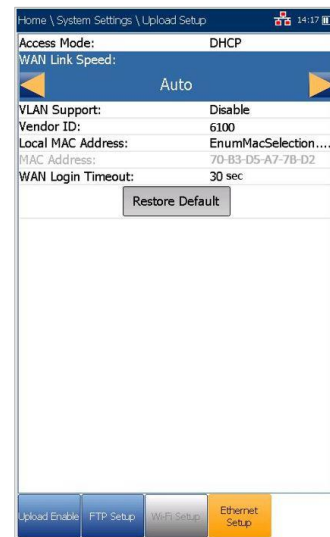

The **Ethernet Setup** function allows you to configure the line and access modes, etc for an Ethernet connection, using the following parameters:

- Access Mode options are DHCP, Static, or PPPoE.

- **WAN Link Speed** is a choice between **Auto** (negotiated during the link establishment), **100** or **10 Mbit/s**.
- WAN Connect Mode is Full- or Half-Duplex, when Link Speed is set to either 100 or 10 Mbit/s.
- **VLAN Support** enables the unit to tag/untag Ethernet frames.
- **VLAN ID** is a virtual local area network (VLANtag ranging from 0 through 4094. The entry is available only when **VLAN Support** is **Enable**.
- **Vendor ID** is the name of the unit. This entry is available only when **Access Mode** is **DHCP**.
- **Local Mac Address** is the *internal* MAC address of the unit: either **6100-Cu** or **User Defined**.
- **Mac Address** is a specific MAC address, in a hexadecimal format, if **User Defined** was selected for the previous parameter. This entry is available only when **Access Mode** is **DHCP** or **Static**.
- **WAN Login Timeout** is a numeric setup entry.

The following parameters are available only when Access Mode is PPPoE.



- **Login Name/Password** is your user ID and password.
- **Obtain IP** is either **Dynamic** where the access concentrator or broadband remote access server assigns a temporary IP address to the unit, or **Static** where you enter the IP address of the unit.

The following parameters are available only when **Access Mode** is **Static**.

- **IP Address** is the address for the unit that is actively connected to your network or the internet at the time of login.
- **Gateway** is the IP address of the default gateway.
- **Subnet Mask** is the network address used to identify if the IP address is within the same wide area network.
- **DNS1** is the address of the primary domain name server to be used by the unit. If **DNS** is unavailable, enter 0.0.0.0.
- **DNS2** is the address of the secondary domain name server to be used by the unit. If DNS is unavailable, enter 0.0.0.0.

- **Restore Default** button allows you to reset the entries to their defaults.

To configure the setup options:

1. Press the up/down arrows to select the desired parameter.
2. Press the left/right arrow keys to view and select the options.
OR
3. Press  on a value to open a list box of options or the alphanumeric editor screen and use the navigation keys to scroll through.
4. Press  to confirm the value.

6.10 Wi-Fi Test

Selecting the **Wi-Fi Test** icon activates the **Wi-Fi Scan** function, listing all the Wi-Fi (wireless) networks available to you.

Wi-Fi Scan

The **Wi-Fi Scan** tab displays all wireless networks available with details that allow you to compare them.

- **Navigate to a Wi-Fi Network for Details** enables you to select a wireless network from the list to view further details below.
 - **Chan.** displays the Wi-Fi channel number.
 - **Network Name** or SSID (service set Identifier) is the name assigned to a wireless network.
 - **MAC Address** or BSSID (basic service set identifier) is the address of the WAP (wireless access point).
 - **RSSI** is the received signal strength indicator returned from the Wi-Fi dongle.
 - **Sort Channels** button allows you to toggle the channel numbers by ascending and descending.
 - **Sort RSSI** button allows you to toggle the RSSI signal strength values by ascending and descending.
- Note: With touchscreen, you can also sort the network names by clicking/tapping the column header.*
- **Hide/Show Hidden Network** button allow you to hide/show hidden networks in the list.

Details of the selected **Network Name** include:

- **Signal (RSSI)** strength may list one of the following levels with the table cell shown in the corresponding colour:
 - **No Signal** (< -90/black)
 - **Very Low** (-90 to -82/red)
 - **Low** (-81 to -72/red)
 - **Good** (-71 to -68/orange)
 - **Very Good** (-67 to -58/yellow)
 - **Excellent** (> -58/green)
- **Channel** displays the Wi-Fi channel number and frequency.
- **Security** displays one of the following encryption and authentication types: NONE, WEP-OPEN, WEP-SHARED, WPA-TKIP, WPAPSK-TKIP, WPA2-TKIP, WPA2PSK-TKIP, WPA-AES, WPAPSK-AES, WPA2-AES, WPA2PSK-AES.
- **Network Type** is either **Access Point** (the infrastructure network or router) or **Adhoc** (spontaneous).

To navigate to a Wi-Fi network and view the details:

5. Press  to get into the list.
6. Press the up/down arrow keys to select a network and view its details below.

- Wi-Fi
- Ethernet
- **Disable Connection** option disables uploads via Wi-Fi or the Ethernet.

When **Wi-Fi** or **Ethernet** are selected, their respective icons are displayed in the top right-hand corner of the navigation bar. The status of whether or not a connection is present is indicated by the color of the icon: green, yellow, or red.

Wi-Fi Setup

The **Wi-Fi Setup** function for **Comms Setup** is the

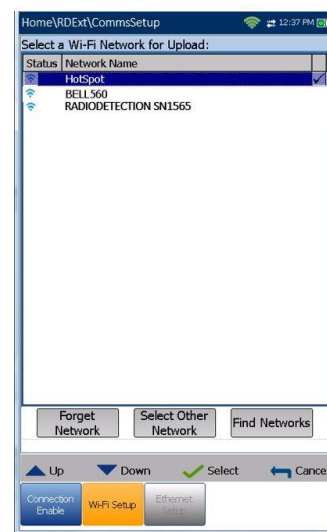

same as in the **System Settings/Upload Setup**. Please see [Wi-Fi Setup](#) on page 18.

6.11 Comms Setup

Connection Enable



The **Connection Enable** tab allows you to choose the Connection Method for upload.

Ethernet Setup

The **Ethernet Setup** function for **Comms Setup** is the same as in the **System Settings/Upload Setup**. Please see [Ethernet Setup](#) on page 19.

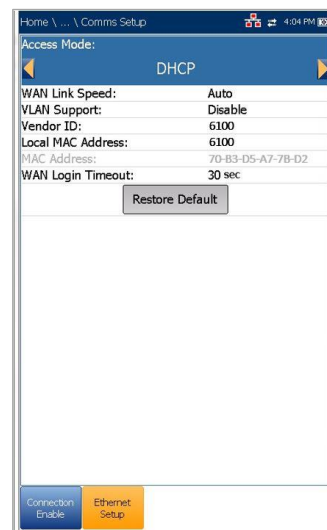



Section 7 Setting Up Copper Tests

The 6100-Cu is designed to test basic twisted pair quality, identify and locate faults, and troubleshoot noise and signal issues. These measurements offer a quick and thorough method to determine if the cable is capable of supporting xDSL technology. In addition, it utilizes noise measurements, longitudinal and stressed balance tests, and power spectral density tests to assist in the installation, maintenance, and troubleshooting of copper cables.

7.1 Copper Test Main Menu

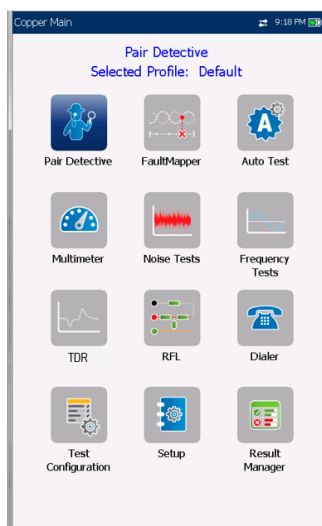
Copper Main presents the main copper menu page which allows you to navigate between all the copper qualification testing applications using the up/down, left/right arrow keys on the keypad.



Press  to run a test, bring up the sub-menu, or perform the application of the selected icon.

7.2 Test Configuration

Before performing copper tests, you can set up the software settings and values for the cables. The 6100-Cu allows you to save test parameters and threshold settings to different profiles and reuse them as needed.

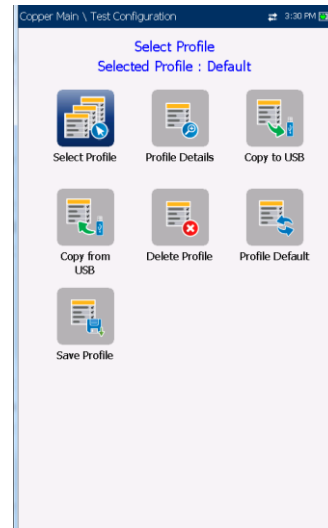

The **Test Configuration** menu provides the utilities to setup test parameters. The 6100-Cu supports several types of copper test applications. Test parameters and thresholds are saved into a test configuration profile. A Profile Default is provided with a predefined set of parameters for all test applications.

Note: Cable parameters are not included in these profiles but can be configured in Setup.

- Select Profile lists available profiles saved in the internal memory. The current active profile is shown in the upper information header.
- An asterisk "*" on the currently Selected Profile name indicates that modifications have been made to this profile in the Threshold Settings or parameters of a particular test.
- At power up, settings are read from the last loaded profile.
- Profile Details lists the tests for configuration:
 - Pair Detective
 - FaultMapper
 - Auto Test
 - Multimeter
 - Noise Tests
 - Frequency Tests
 - TDR
- **Copy to USB** allows you to copy all profiles found in the internal memory to an external USB device. If the profile name already exists in the destination folder, you will be prompted to overwrite existing profile(s).
 - You can overwrite each file individually by pressing the **Yes** button, or overwrite all by pressing **Yes to All**.

- If **Yes to All** is not pressed, then individual files may be overwritten by pressing **Yes**, or skipped by pressing **No**.
- You can terminate the process by pressing **Cancel**.
- **Copy from USB** allows you to copy all profiles found on an external USB device to the unit.
- **Delete Profile** allows you to delete a profile (except the default profile) on the unit.
- **Profile Default** resets the current test setup to the factory default profile. If selected, a dialogue box pops up to confirm that all single and auto test settings will revert to factory test settings.
- **Save Profile** allows you to save changes made to a selected profile. An asterisk "*" on the **Selected Profile** name indicates that modifications have been made in the **Threshold Settings** or parameters of a particular test. the following function keys.

To save a profile, use one of the following function keys:

- **Save** allows you to save to the currently selected profile name.
- **Save As** opens the alphanumeric editor screen allowing you to enter a new name for the profile selected.
- **Don't Save** deletes the message box without saving the changes to the currently selected profile.

To navigate between the configuration icons:

1. Press the up/down left/right arrow keys on the keypad to select an icon.
2. Press  to confirm your selection.

Select Profile

The **Select Profile** page lists the available profiles in the internal memory, by **Profile Name** and **Modification Date**.



The **Selected Profile** displays the current active profile. To select a profile:

1. Press the up/down arrow keys to highlight the desired entry and press . The profile is loaded and the **Selected Profile** is updated with the current selection.

OR

2. Press  to cancel your selection and go back to the **Test Configuration** menu.

Profile Details Main Menu

You can view any of the currently selected test parameters from the **Profile Details** menu by selecting the desired test icon. An asterisk * on the **Selected Profile** name indicates that modifications have been made to this profile in the threshold settings or parameters of a particular test.

Each test displays a sub-menu of test icons to select and view.

To select a test:

1. Press the up/down left/right arrow keys on the keypad to select an icon.
2. Press  to display the sub-menu test icons.

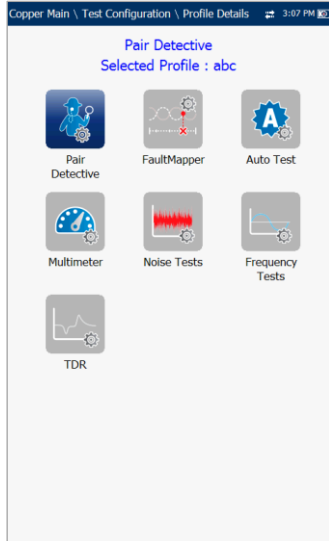

To navigate between the test profiles:

1. Press the up/down left/right arrow keys on the keypad to select an icon.
2. Press to confirm your selection.

Noise Tests Profile Details

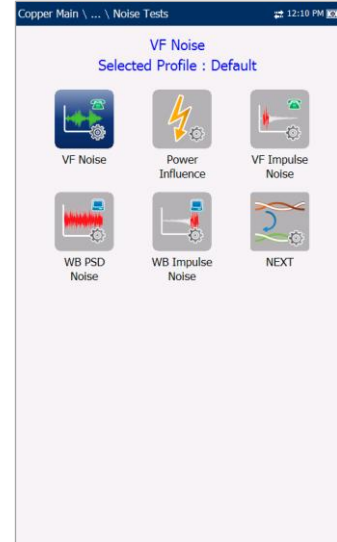

Multimeter Profile Details

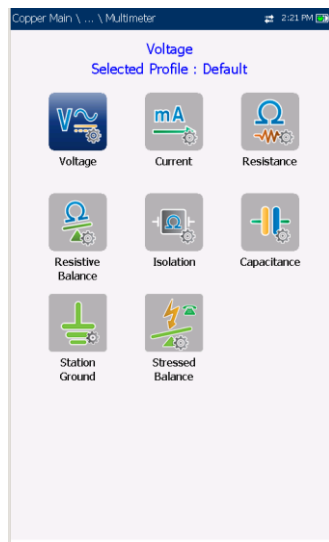

The profile details **Noise Tests** main menu allows you to view the test threshold and parameters of the following tests:

- VF Noise
- Power Influence
- VF Impulse Noise
- WB PSD Noise
- WB Impulse Noise
- NEXT

The profile details **Multimeter** main menu allows you to view the test threshold and parameters of the following tests:

- Voltage
- Current
- Resistance
- Resistive Balance
- Isolation
- Capacitance/Opens
- Station Ground
- Stressed Balance

To navigate between the test profiles:

1. Press the up/down left/right arrow keys on the keypad to select an icon.
2. Press to confirm your selection.

Frequency Tests Profile Details

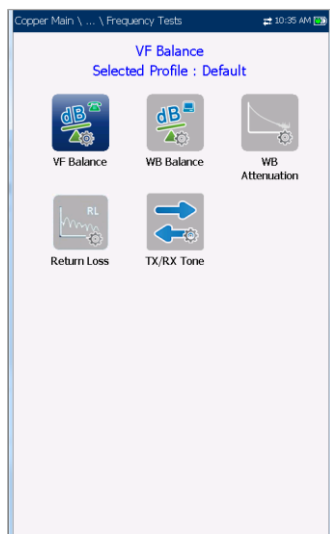

The profile details **Frequency Tests** main menu allows you to view the test threshold and parameters of the following tests:

- VF/AC Balance
- WB Balance
- WB Attenuation
- Return Loss
- TX/RX Tone
- RX Tone with FED

To navigate between the test profiles:

1. Press the up/down left/right arrow keys on the keypad to select an icon.
2. Press  to confirm your selection.

TDR Profile Details

The profile details **TDR menu** allows you to select and view the parameters set for the following tests:

- Auto TDR
- Manual TDR
- xTalk TDR

To navigate between the test profiles:

1. Press the left/right arrow keys on the keypad to select an icon.
2. Press  to confirm your selection.

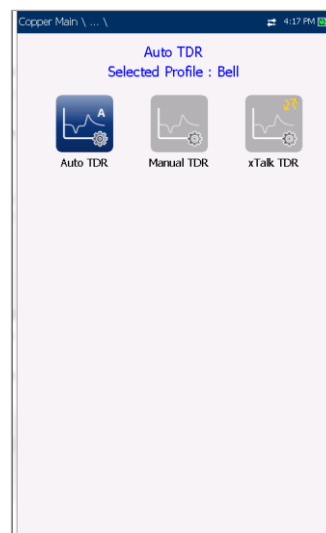

Auto Test Profile Details

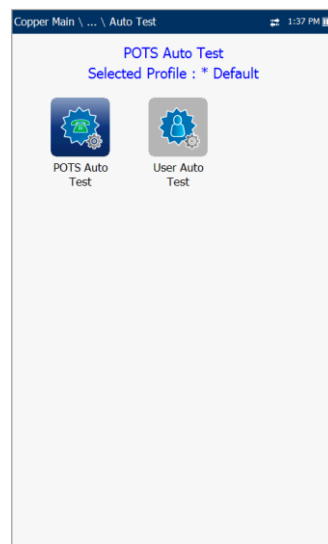

The profile details **Auto Test** main menu allows you to view the test threshold and parameters of the following tests:

- POTS Auto Test
- User Auto Test

To navigate between the test profiles:



1. Press the up/down left/right arrow keys on the keypad to select an icon.
2. Press  to confirm your selection.

Delete Profile

Delete Profile lists all profiles found on the internal memory except the default profile, which cannot be removed.

Selected Profile displays the profile name in use.



To delete a profile:

1. Press the up/down arrow keys to highlight the entry to be removed and press .
2. Press the Delete function key to remove the entry from the unit.
OR
3. Press  to cancel your selection, remove any display message, and go back without impacting any profiles.

7.3 Setup

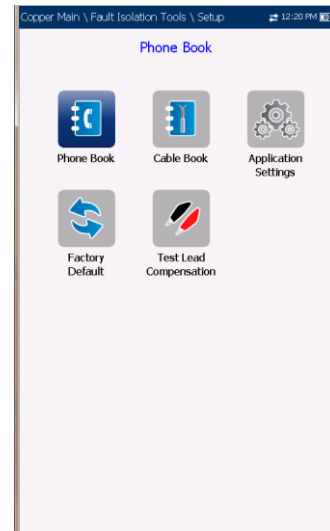
The **Setup** function allows you to set up parameters common to all tests.

**To access the Setup function:**

1. On the **Home** pane, highlight **Copper Test**, then press .
2. From the **Copper Main** page select **Setup** and press .

Setup presents a menu of items to set up copper tests.

- **Phone Book** includes pages to setup and save groups of phone numbers.
- **Cable Book** includes pages to select, add, clone, and delete a cable, as well as modify its details.
- **Application Settings** include the following pages: **General**, **Standard**, **Identification**, **File Name**, and **Buzzer**. Current settings are kept in memory and are independent of the profiles.
- **Factory Default** allows you to revert the **Phone Book** and/or **Application Settings** to the factory default values.
- **Test Lead Compensation** overwrites the current test lead characteristics to start resistance and capacitance compensation based on the cable temperature of the test lead.

To navigate between the setup icons:

1. Press the up/down left/right arrow keys on the keypad to select an icon.
2. Press  to confirm your selection.

7.4 Phone Book

The **Phone Book** menu presents a selection of functions which allow you to manage the groups of phone numbers relevant to performing the copper tests. It can include a maximum of 50 groups of up to 3 individual entries each. The functions are as follows:

- Select Group/Entry
- Phone Book Details
- Add Group
- Clone Group
- Delete Group
- Load Phone Book
- Save Phone Book



To navigate between the phone book functions:

1. Press the up/down left/right arrow keys on the keypad to select an icon.
2. Press to confirm your selection.

Select Group/Entry

The page lists entries by **Group ID** and **Entry Name/Type**. There is 1 group of 3 factory default entries which cannot be edited or deleted. The **Phone Book** can include a maximum of 50 groups.

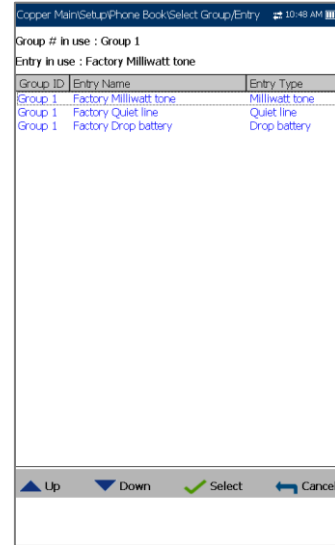

Group # in use displays the group number in use.

To select a group and entry:

1. Press the up/down arrow keys to highlight the desired entry and press . **The Group # in Use** is updated with the current selection.
OR
2. Press to cancel your selection and go back to the **Phone Book** menu.

Phone Book Details

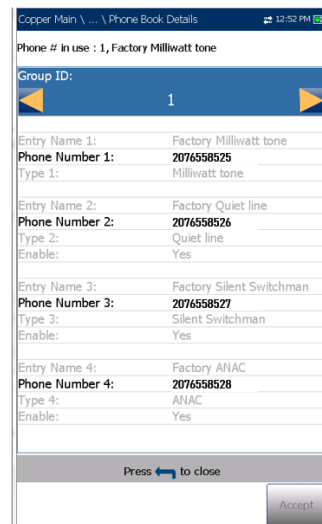

The **Phone Book Details** page allows you to view and modify the **Phone Book** parameters of the currently highlighted phone entry. You can also enable/disable entries 2 and 3 in each phone group.

When creating a new phone group, only entry 1 is enabled. Entries 2 and 3 remain disabled until entry 1 is filled in.



- **Group ID** displays the group ID number. This is the only parameter that cannot be modified however you can navigate between the available phone groups.
- **Entry Name** is the name of the entry in the **Phone Book**.
- **Phone Number** is the 10-digit numeric phone number of the entry.
- **Type** displays the following list of values:
 - Milliwatt tone
 - Quiet line
 - Drop battery
 - - (for additional line types)
- **Enable** displays either Yes or No.
- **Accept** function key validates and updates all the parameters of the Phone Book.

To view and modify the group details:

1. Press the up/down arrow keys to highlight the desired parameter.
2. Press the left/right arrow keys to view and select the options.
OR
3. Press  on a value to open a list box of options or the alphanumeric editor screen and use the navigation keys to scroll through.
4. Press  to confirm the value.
5. Press the **Accept** function key to update the **Phone Book** with your changes.

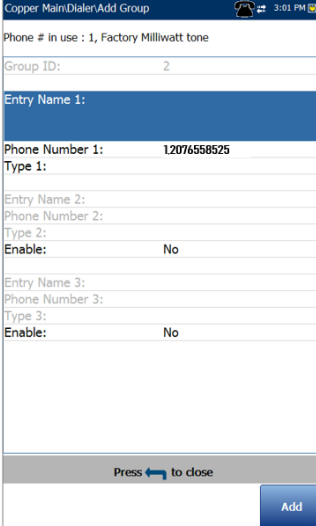

Add Group

The **Add Group** page allows you to add a new group entry into the Phone Book using the following parameters for the currently highlighted Group ID.



- **Group ID** displays the group ID number. This parameter cannot be modified.
- **Entry Name** is the name of the entry in the **Phone Book**.
- **Phone Number** is the 10-digit numeric phone number of the entry.
- **Type** displays the following list of values:
 - Milliwatt tone
 - Drop battery
 - Quiet line
 - - (for additional line types)
- **Enable** displays either **Yes** or **No**.
- **Add** function key adds the new group entry to the Phone Book.

To add a new group entry:

1. Press the up/down arrow keys to highlight the desired parameter.
2. Press the left/right arrow keys to view and select the options.
OR
3. Press  on a value to open a list box of options or the alphanumeric editor screen and use the navigation keys to scroll through.
4. Press  to confirm the value.
5. Press the **Add** function key to append the new group entry to the end of the **Phone Book**. If the maximum number of **Phone Book** entries has been reached, delete an entry before adding a new one.

Clone Group

The **Clone Group** page allows you to copy the details of an existing entry to a new group entry in the **Phone Book**. The page lists all entries by **Group ID**.

The list can display a maximum of 50 entries.

Group # In Use displays the **Group ID** number in use.

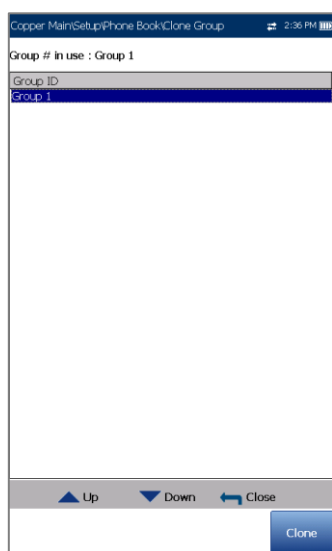

To clone a group entry:

1. Press the up/down arrow keys to highlight the desired entry.
2. Press the Clone function key to copy the details of the highlighted entry and append a new Group ID to the list.

OR

3. Press  to cancel your selection and go back to the **Phone Book** menu.

Delete Group

The **Delete Group** page allows you to delete a group entry from the **Phone Book**. The page lists all entries by **Group ID**.

Group # in Use displays the group number in use.

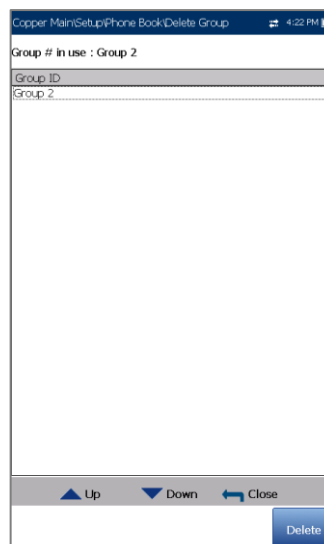

To delete a group entry:

1. Press the up/down arrow keys to select the entry to be removed.
2. Press the **Delete** function key to remove the selected entry from the **Phone Book**. If you try to delete a cable in use, a warning message pops-up and changes the **Group # in Use** to Group 1 by default.

OR

3. Press  to cancel your selection, remove any display message, and go back without impacting the **Phone Book**.

Load Phone Book

The **Load Phone Book** page allows you to import a phone book. The page displays the file name and date of the last phone book loaded. Only .csv files are supported.

- The **Storage Location** lists the load destinations:
 - Internal memory
 - USB
- **File Name** lists the phone book file name(s) to load.
- **Load** button imports the selected phone book.
- You will be prompted for confirmation since this action will overwrite the current phone book.
- **Cancel** button removes the confirmation/warning message without impacting the phone book.

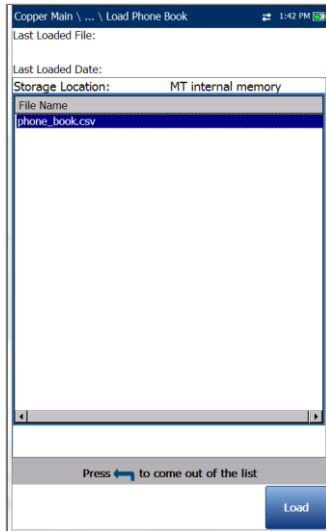

To load a phone book:

1. Select the **Storage Location** using the left/right arrow keys.
OR
2. Press **✓** to display the list of options.
3. Using the up/down arrow keys, select a file name to load.
4. Press **Load** and confirm. The unit will remove the existing phone book and replace it with the loaded one.
OR
5. Press **Cancel** to remove the message.

Save Phone Book

The **Save Phone Book** page allows you to save or export a phone book.

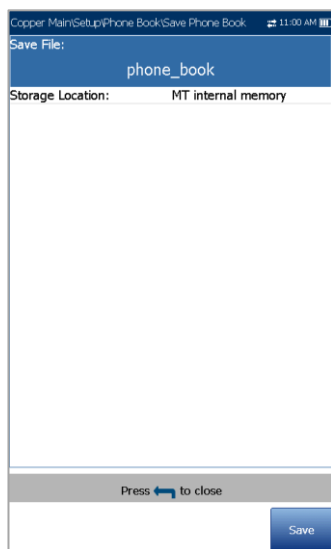

- **Save File** allows you to enter a file name of the current phone book to save. By default, the name is phone_book.csv.
- The **Storage Location** lists the save destinations:
 - Internal memory
 - USB
- **Save** button saves the selected file.

Note: The unit will overwrite any document with the same file name found on the disk, without warning.

To save a phone book:

1. Accept the default file name or press **✓** to create a new one using the edit screen.
2. Select a **Storage Location**.
3. Press **Save**.

7.5 Dialer Function

The **Dialer** function provides a dial-up path from the 6100-Cu to another tester (or quiet termination or silent switchman) through a switched circuit network. DTMF (dual-tone multi-frequency) transmission is enabled via the phone keypad allowing you to place POTS calls.

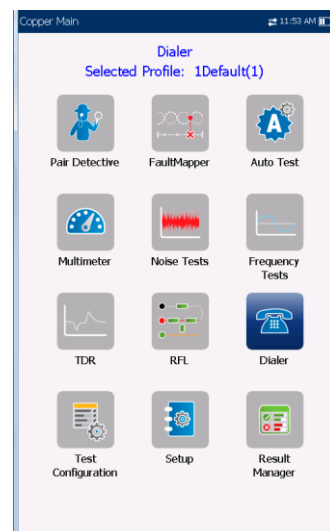

The dialer can be accessed from the **Copper Main** or **Multimeter** (if FED option enabled) pane and is also integrated into individual test screens to give you quick access to the manual dialer function, speed dial and last dialed lists, without exiting the current test application.

To access the Dialer function:

1. On the **Home** pane use the up/down arrow keys to highlight **Copper Test**, then press **✓**.
2. From the **Copper Main** or **Multimeter** (if FED option enabled) page select **Dialer** and press **✓**.



Dialer

Dialer provides the following functions:

- The means to call and signal voice switch test functions, such as drop battery, quiet line, and more.
- It is integrated with **POTS Auto Test** and other manual test screens for easy access to the switch functions during those tests. For example, when testing for load coils, you can remove the line battery and use the dialer function to signal the switch to drop battery, and then run the load coil test.
- It is DTMF and can also be used to control a DTMF FED (Far End Device) by entering specific FED DTMF commands.

- Allows you to use the unit as a telephone (with the built-in speaker or external headset and the on-screen phone keypad as a dialer) when Enter Number is invoked, whether in the test results screens or through the separate dedicated Dialer application.

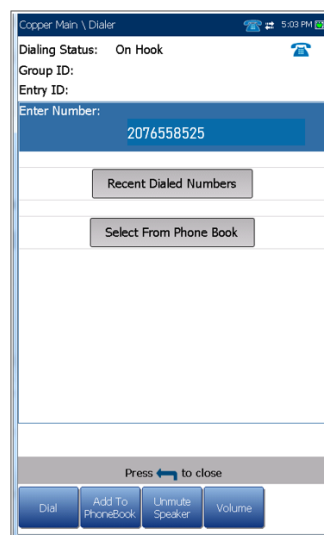

The following parameters can be accessed from this page:

- **Dialing Status** shows the current status of the dialed number.
- **Group ID** displays the group ID number of the dialed number if it was selected from the **Phone Book**.
- **Entry ID** displays the **Entry Name** of the dialed number if it was selected from the **Phone Book**.
- **Enter Number** displays the telephone number entered, or selected from the **Recent Dialed Numbers** list or **Phone Book**.
- **Recent Dialed Numbers** button opens a list of recently dialed numbers for selection.
- **Select From Phone Book** button allows you to select a number from the **Phone Book**.
- Function Keys:
 - **Dial/Hang Up** allows you to dial the selected or entered number, and hang up the dialer.
 - **Add To Phone Book** saves the entered number to the **Phone Book**.
 - **Mute/Unmute Speaker** changes the speaker status.
 - **Volume** adjusts the volume level.

To dial a number:

1. Use the up/down arrow keys to highlight an entry or button and press .
2. Enter a new phone number using the on-screen keypad or select an existing one from the lists.
3. Press the **Dial** function key to start the call.

Enter Number

The **Enter Number** box is where you enter the phone number you wish to dial.

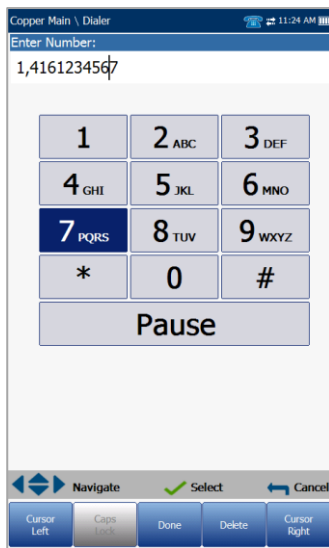
**To enter a phone number:**

1. Press any of the buttons on the keypad by using the navigation keys on the unit and pressing . The selected numbers are entered in the text box.
2. Press **Pause** to enter a 1-second pause while dialing. For example, pressing **Pause** consecutively 3 times, creates a 3-second pause.
3. Move left or right in the text box by using **Cursor Left/Right** function keys.
4. Delete a character by moving the cursor to the left of the character and pressing the **Delete** function key.
5. Press **Done** function key when you have completed entering a phone number.

Note: Alphabets on the keypad are for reference only. Pressing any of the buttons will not show the alpha-character in the text box.

Recent Dialed Numbers

The **Select Number** page lists a maximum of 8 recently dialed telephone numbers which you can select to make your call.

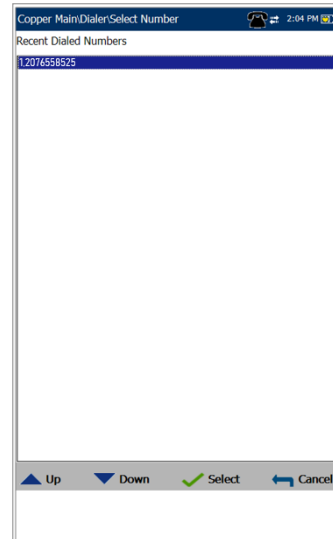

To select a recently dialed number:

1. Use the up/down arrow keys to select an entry.
2. Press  to confirm your choice. The number is automatically entered in the **Enter Number** field of the **Dialer** page.

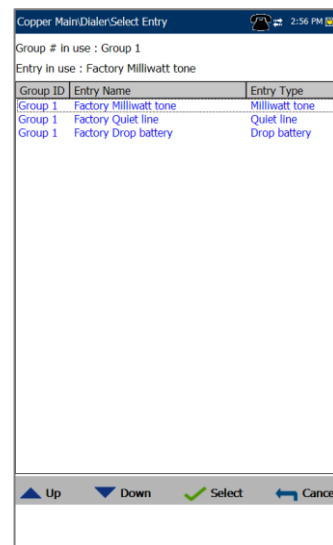
Select from Phone Book

The Select Entry read-only page lists entries by Group ID and Entry Name/Type. There is 1 group of 3 factory default entries. The Phone Book can include a maximum of 50 groups.

- **Group # in Use** displays the group number in use.
- **Entry in use** displays the **Entry Name** in use.

To select a group and entry:

Press the up/down arrow keys to highlight the desired entry and press **✓**. **The Group # in Use** is updated with the current selection and automatically entered in the **Enter Number** field of the **Dialer** page.

Add to Phone Book

The **Add Group** page allows you to add a new group entry into the **Phone Book** using the following parameters for the currently highlighted **Group ID**.

- **Group ID** displays the group ID number. This parameter that cannot be modified.
- **Entry Name** is the name of the entry in the **Phone Book**.
- **Phone Number** is the 10-digit numeric phone number of the entry.
- **Type** displays the following list of values:
 - **Milliwatt tone**
 - **Drop battery**
 - **Quiet line**
 - - (for additional line types)
- **Enable** displays either **Yes** or **No**.
- **Add** function key adds the new group entry to the **Phone Book**.

To add a number to the phone book:

1. Press the up/down arrow keys to highlight the desired parameter.

2. Press the left/right arrow keys to view and select the options.

OR

3. Press **✓** on a value to open a list box of options or the alphanumeric editor screen and use the navigation keys to scroll through.
4. Press **✓** to confirm the value.
5. Press the **Add** function key to append the new group entry to the end of the **Phone Book**. If the maximum number of **Phone Book** entries has been reached, delete an entry before adding a new one.

7.6 Cable Book

The **Cable Book** menu allows you to select, add, clone, and delete a cable, as well as modify its details, such as:

- **Select Cable**
- **Cable Details**
- **Add Cable**
- **Clone Cable**
- **Delete Cable**
- **Load Cable Book**
- **Save Cable Book**

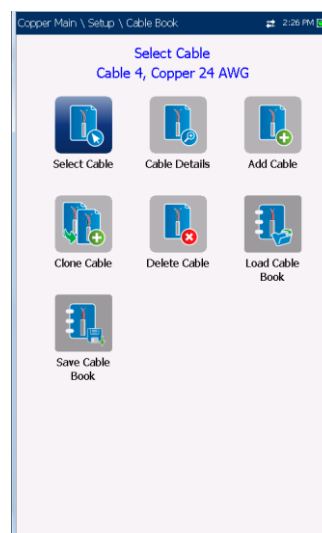

To navigate between the cable book functions:

1. Press the up/down left/right arrow keys on the keypad to select an icon.
2. Press **✓** to confirm your selection.

Select Cable

The **Select Cable** page lists entries by **ID**, **Cable Name**, and **Cable Fill**. The list can display a maximum of 25 entries. Only the cables from the selected **Cable Book** will be available for selection in test screens. Also, only cables from the **CableBookSettings** can be edited or deleted.

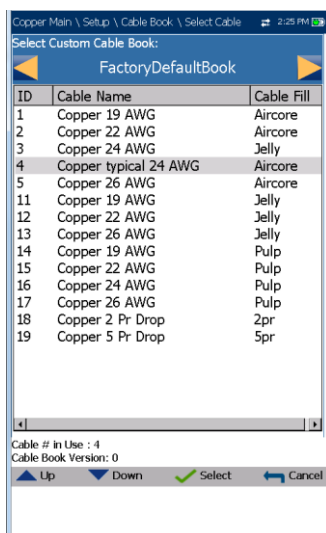

- **Select Custom Cable Book**
 - **FactoryDefaultBook**
 - **CableBookSettings**
 - **ItalianCableBook**
 - **UKCableBook**
 - **FranceCableBook**
 - **Cable # in Use** displays the **ID** number of the cable in use.
 - **Cable Book Version** displays the current edition number of the **Cable Book** in use.

To select a cable in use:

1. Press the up/down arrow keys to highlight the desired entry and press **✓**. The **Cable # in Use** is updated with the current selection displaying **Cable Details**.
OR
2. Press **←** to cancel your selection and go back to the **Cable Book** menu.

Cable Details

The **Cable Details** page allows you to view the parameter details of the **Cable # in Use**, or select a

Cable ID number by pressing the left/right arrow keys on the keypad and view its details. You can only modify cables from the **CableBookSettings** book, see above.

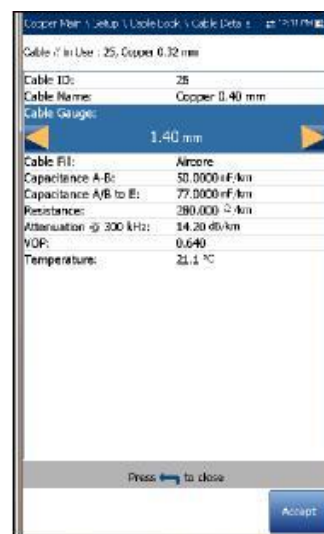



- **Cable Name** is the name of the cable in the **Cable Book**.
- **Cable Gauge** is the gauge system for measuring wire sizes in AWG (American Wire Gauge) units or mm (metric wire size).
- **Cable Fill** is the type of material the cable is filled with: Aircore, Jelly, Pulp, 5 PR, or 2 PR.
- **Capacitance T-R/A-B** specifies a value for the capacitance per length constant.
- **Capacitance T/R to GND/A/B to E** specifies a value for the capacitance per length to ground constant.
- **Resistance** specifies a value for the resistance constant of the cable.
- **Attenuation @ 300 kHz** specifies a value for the reduction in signal strength or insertion loss of the cable.
- **VOP Ratio** is the velocity of propagation for the cable as a ratio of the speed of light
- **VOP Percentage** is the velocity of propagation for the cable as a percentage of the speed of light
- **VOP V/2 m/μs** is the velocity of propagation for the cable in m/μs divided by 2
- **Temperature** specifies the temperature of reference at which all cable parameters have been measured, in either °F (Fahrenheit) or °C (Celsius) units. The measurement units are updated based on the **Temperature** settings in **Setup/Application Settings/Standard**.

To view and modify the cable details:

1. Press the up/down arrow keys to highlight the desired parameter.
2. Press the left/right arrow keys to view and select the options.

OR

3. Press  on a value to open a list box of options and use the navigation keys to scroll through.
4. Press  to confirm the value.
5. Press the **Accept** function key to update the cable details with your changes.

- **Capacitance T/R to GND/A/B to E** allows you to specify a value for the capacitance per length to ground constant.
- **Resistance** allows you specify a value for the resistance constant of the cable.
- **Attenuation @ 300 kHz** allows you to specify a value for the reduction in signal strength or insertion loss of the cable.
- **VOP** allows you to set the velocity of propagation for the cable.
- **Temperature** specifies the temperature of reference at which all cable parameters have been measured.
- **Add** function key adds the new cable entry to the **Cable Book**.

Add Cable

The **Add Cable** page allows you to add a new cable entry into the **CableBookSettings** using the following parameters for the currently highlighted **Cable ID**.

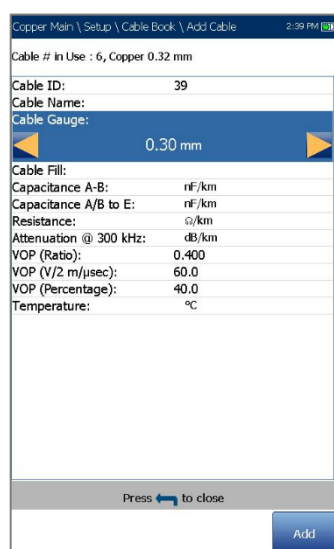



- **Cable ID** displays the cable ID number. This parameter that cannot be modified.
- **Cable Name** is the name of the cable in the **Cable Book**.
- **Cable Gauge** is the gauge system for measuring wire sizes in AWG (American Wire Gauge) units or mm (metric wire size).
- **Cable Fill** allows you to select the type of material the cable can be filled with: **Aircore**, **Jelly**, **Pulp 5**, **PR**, or **2 PR**.
- **Capacitance T-R/A-B** allows you to specify a value for the capacitance per length constant.

To add a new cable entry:

1. Press the up/down arrow keys to highlight the desired parameter.
2. Press the left/right arrow keys to view and select the options.

OR

3. Press  on a value to open a list box of options or the alphanumeric editor screen and use the navigation keys to scroll through.
4. Press  to confirm the value.
5. Press the **Add** function key to append the new cable entry to the end of the **CableBookSettings**. If the maximum number of Cable Book entries has been reached, delete an entry before adding a new one.

Clone Cable

The **Clone Cable** page allows you to copy the cable details of an existing entry from the selected **Cable Book** to a new cable entry in the **CableBookSettings**. The page lists all entries by **ID**, **Cable Name**, and **Cable Fill**.

- **Cable # in Use** displays the ID number of the cable in use.
- **Cable Book Version** displays the current edition number of the Cable Book in use.

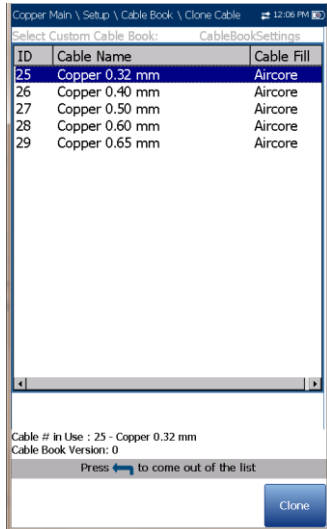

To clone a cable entry:

1. Press the up/down arrow keys to highlight the desired entry and press ✓.
2. Press the **Clone** function key to copy the details of the highlighted entry and append a new **ID** to the **CableBookSettings** list.

OR

3. Press ← to cancel your selection and go back to the Cable Book menu.

Delete Cable

The **Delete Cable** page allows you to delete a cable entry from the selected **Custom Cable Book**. The page lists all entries by **Cable ID**, **Cable Name**, and **Cable Fill**.

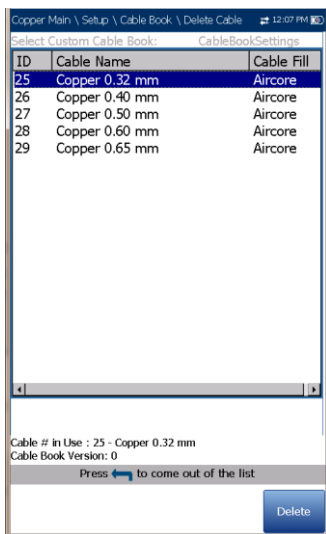

- **Cable # in Use** displays the **ID** number of the cable in use.
- **Cable Book Version** displays the current edition number of the **Cable Book** in use.

To delete a cable entry:

1. Press the up/down arrow keys to highlight the entry to be removed and press ✓.
2. Press the **Delete** function key to remove the entry from the **Custom Cable Book**. If you try to delete a cable in use, a warning message pops-up and changes the **Cable # in Use** to cable #1 by default.

OR

3. Press ← to cancel your selection, remove any display message, and go back without impacting the **Cable Book**.

Load Cable Book

The **Load Cable Book** page allows you to import a cable book. The page displays the file name and date of the last phone book loaded. Only .csv files are supported.

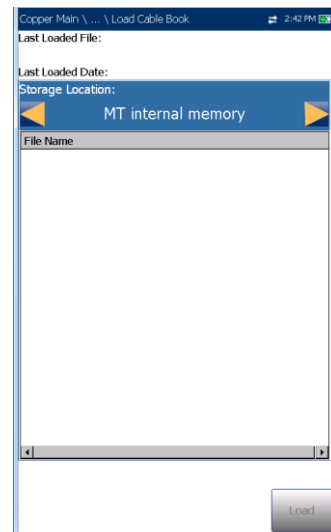

- The **Storage Location** lists the load destinations:
 - **Internal memory**
 - **USB**
- **File Name** lists the cable book file name(s) to load.
- **Load** button imports the selected cable book. You will be prompted for confirmation since this action will overwrite the current cable book.

- **Cancel** button removes the confirmation/warning message without impacting the cable book.

To load a cable book:

1. Select the **Storage Location** using the left/right arrow keys.
OR
2. Press **✓** to display the list of options.
3. Using the up/down arrow keys, select a file name to load.
4. Press **Load** and confirm. The unit will remove the existing cable book and replace it with the loaded one.
OR
5. Press **Cancel** to remove the message.

Save Cable Book

The **Save Cable Book** page allows you to save or export a cable book.

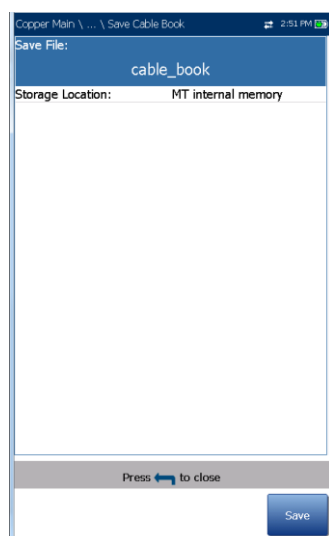

- **Save File** allows you to enter a file name of the current cable book to save. By default, the name is cable_book.csv.
- The **Storage Location** lists the save destinations:
 - **Internal memory**
 - **USB**
- **Save** button saves the selected file.

Note: The unit will overwrite any document with the same file name found on the disk, without warning.

To save a cable book:

1. Accept the default file name or press **✓** to create a new one using the edit screen.
2. Select a **Storage Location**.
3. Press **Save**.

7.7 Application Settings

Before executing the copper tests, set up the software settings and values for the cables. The 6100-Cu allows you to save standard parameter settings to different profiles and reuse them as needed.

To access Application Settings:

From the **Home** pane, select **Copper Test**, then **Setup**, and **Application Settings**.

General

The **General** tab allows you to configure the unit with specific measurement values and graph viewing settings.

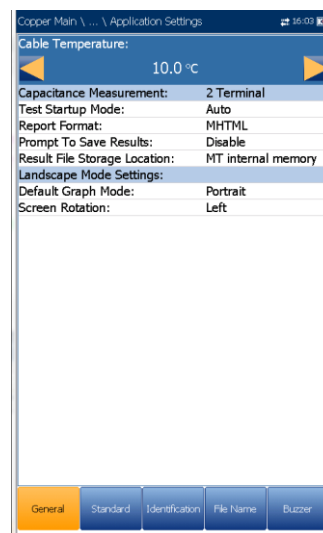

Each parameter is described below:

- **Cable Temperature** specifies the temperature of the cable under test in either °F (Fahrenheit) or °C (Celsius) units.
- **Capacitance Measurement** is either **3 Terminal** or **2 Terminal**. The latter method measures the capacitance across the 2 terminals specified (either T-R, T-G, R-G or A-B, A-E, B-E), whereas the **3 Terminal** method



measures the capacitance across the 2 terminals specified, and shorts the remaining (or unspecified) terminal to G/E. The **3 Terminal** method is more common and is the default. Continue to use it unless you know you need the **2 Terminal** method.

*Note: In order to correctly determine cable length by using the **Capacitance Measurement**, the **Cable Book** must contain both 3/2 Terminal values.*

*Note: The accuracy of the **2 Terminal Capacitance Measurement** is impacted by the use of the **FED**, and the **3 Terminal** method is recommended to be used instead.*

- **VOP Compensation** offsets length calculation inaccuracy caused by the changes in velocity of the pulse propagation, depending on the pulse width and cable length produced by skin effect; and is applied to **TDR**, **WB Attenuation**, and **FaultMapper** tests.
- **Test Startup Mode** lists the test startup type:
- **Auto** (default) automatically starts a test when you select the respective icon from the test sub-menu pane and press .
- **Manual** requires that you press Start/Stop on the 6100-Cu keypad to start a test.
- **Report File Storage Location** is **USB** which is automatically selected.
- **Report Format** is **HTML**, **MHTML**, or **XML** as the generated report format.
- **Prompt To Save Results** allows you to Enable/Disable popup confirmation messages before leaving a test and not saving results.
- **Result File Storage Location** allows you to select where to save your results: to a **USB** or the internal memory of the 6100-Cu.
- **Landscape Mode Settings**:
 - **Default Graph Mode** sets the default graph viewing mode to either **Portrait** or **Landscape**.
 - **Screen Rotation** sets your preferred default rotation of the unit for viewing graphs in Landscape mode. Select either **Right** to rotate the 6100-Cu 90 degrees clockwise so that the keypad is on the left-hand side, or **Left** to rotate the unit 90 degrees counter-clockwise so that the keypad is on the right-hand side.

To select the parameter values:

1. Press the up/down arrow keys to highlight the desired parameter.
 2. Press the left/right arrow keys to view and select the options.
- OR
3. Press  on a value to open a list box of options or the alphanumeric editor screen and use the navigation keys to scroll through.
 4. Press  to confirm the value.

Standard

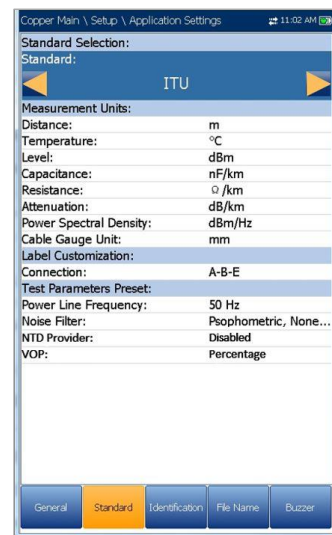

The **Standard** tab allows you to set unit parameter values composed of the following:



- Standard Selection
- **Standard** allows you to specify if the copper tests should conform to the ITU (International Telecommunications) or ANSI (American National Standards Institute) standard.

*Note: Selecting the **Standard** resets the default **Measurement Units**, **Label Customization**, and **Test Parameters Preset** for the page.*

- Measurement Units
 - **Distance** lists the measurement units for distance in feet or meters.
 - **Temperature** lists the measurement units for temperature in °F (Fahrenheit) or °C (Celsius).
 - **Level** lists the units of power level in dBm or dBm.

- **Capacitance** lists the units of capacitance for Tip and Ring in **nF/km** or **nF/mi**.
- **Resistance** lists the units for resistance in **Ω/km** or **Ω/mi**.
- **Attenuation** lists the units for the reduction in signal strength or insertion loss of the cable, in **dB/km** or **dB/mi**.
- **Power Spectral Density (PSD)** lists the units to measure the noise energy at a point in a noise spectrum. Units are dependent on the previously selected **Level**.
- **Cable Gauge Unit** allows you to select either **AWG** or **mm** wire gauge. AWG is the default for ANSI and mm for ITU. If you select AWG, only AWG cables will be displayed in the **Cable Book\Select Cable** list and test pages.
- **NTD (Network Terminal Device) Provider** allows you to filter out certain devices in the Pair Detective test dependent on your provider. None (default) filters out all devices except Short, Phone, and Phone Off Hook. **Disabled** does not run the Device Detection as part of Pair Detective test.
- **VOP** allows you to select the velocity of propagation for the cable as a Ratio, Percentage, or V/2 m/μs (meters per microsecond).
- **Label Customization**
 - Connection** lists the type of cable connection: **T-R-G** or **A-B-E**.
- Test Parameters Preset
 - **Power Line Frequency** lists the frequency value of the power line.
 - **Noise Filter** lists the type of noise filters to use.

To select the parameter values:

1. Press the up/down arrow keys to highlight the desired parameter.
2. Press the left/right arrow keys to view and select the options.
OR
3. Press  on a value to open a list box of options.
4. Press  to confirm the value.

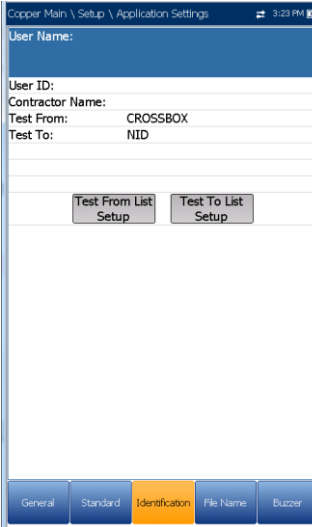

Identification



The **Identification** tab allows you to preset values to identify each single and auto test result file when saving them. The parameters are as follows:

- **User Name/User ID** allow you to enter up to 25 alphanumeric characters, in each field.
- **Contractor Name** allows you to enter the name of a contractor used to perform the tests.
- **Test From/To** allows you to select from a list of entries - up to 20 each, including user defined values.
- **Test From/To List Setup** buttons open separate list management pages.

To select the parameter values:

1. Press the up/down arrow keys to highlight the desired parameter.
2. Press the left/right arrow keys to view and select the options.
OR
3. Press  on a value to open a list box of options or the alphanumeric editor screen and use the navigation keys to scroll through.
4. Press  to confirm the value.

Test List Setup

The **Test From List Setup** and **Test To List Setup** pages allow you to manage the entries of the list. However, there are 5 entries by default which cannot be edited or deleted. These are **DSLAM**, **NID**, **CPE**, **CROSSBOX**, and **FRAME**. When any of these are selected, the **Delete** and **Accept** buttons are disabled.

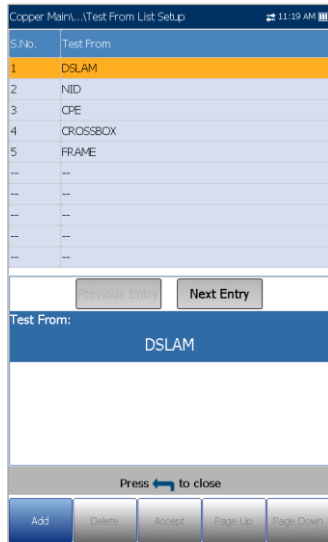

A maximum of 20 different entries can be added.

To manage the list:

1. Press the left/right arrow keys to select the **Previous/Next Entry** buttons and press  to select the previous/next entry.
2. Press **Page Up/Down** function keys to see entries on the previous or next pages. These keys are disabled if no other pages exist.
3. Press **Add** function key to add an entry just below the selected entry in the list.
4. To edit an entry, press the up/down arrow keys to highlight the selected test. Press **Accept** function key to confirm the changes. If you press **Previous/Next Entry** buttons before the **Accept** function key, the edited value will be lost.
5. Press **Delete** function key to delete any entry you have added.

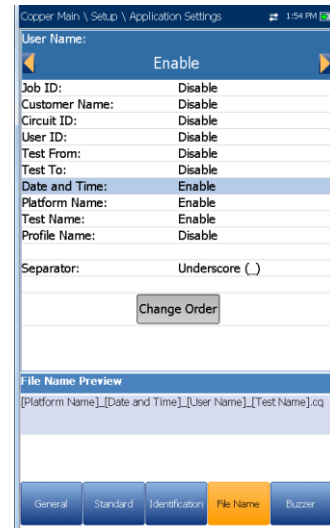

File Name

The **File Name** tab sets up the standard configuration for automatically naming a result file. You can only **Enable/Disable** the entries. All enabled entries are considered for file name generation.



- **File Name Preview** displays a preview of the file name. The actual values of the enabled entries are not shown.
- **Date and Time** value format depends on the format selected in **System Settings**. This entry cannot be disabled.
- **Separator** allows you to choose a value to separate the enabled entries in the file name, e.g.: **Space** (), **Dash** (-), **Underscore** (_).
- **Change Order** button allows you to change the order of the file name entries by moving them up or down in the list.

To select an entry and choose a value:

1. Press the up/down arrow keys to highlight the desired entry.
2. Press the left/right arrow keys to view and select the options.
OR
3. Press  on a value to open a list box of options.
4. Press the up/down arrow keys to select the option and press  to confirm your selection.

Change Order

Change Order page allows you to change the order of the File Name Fields in the list.

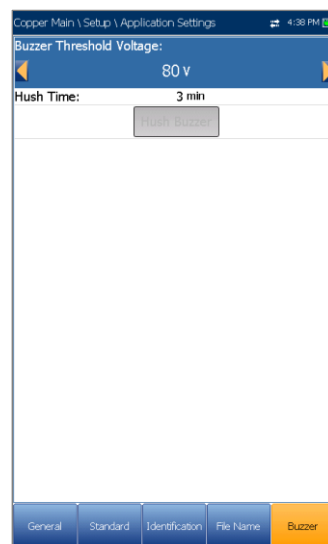
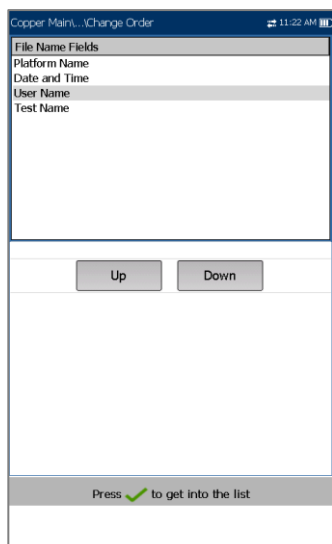

To change the order:

1. Press **✓** to get into the list.
2. Use the up/down arrow keys to select the desired entry.
3. Press **↶** to come out of the list.
4. Press the up or down arrow key to activate the **Up/Down** buttons.
5. Using the left/right arrow keys, select **Up/Down** and press **✓** to move the entry up/down the list.
6. Press **↶** to go back to the **File Name** tab. The **File Name Preview** will be updated with your changes.

Buzzer

The **Buzzer** is a built-in, continuous warning system to detect hazardous voltage levels on the line/test leads. The tab allows you to configure values for the buzzer settings. However, due to the risk of electrical shocks, the 6100-Cu detects high voltages on any pair of leads without user intervention.

- **Buzzer Threshold Voltage** allows you to configure the hazardous voltage level from 70 to 150 volts.
- **Hush Time** allows you to configure the hush timeout from 1 to 15 minutes.
- **Hush Buzzer** button mutes the sounding buzzer.

Note: When the 6100-Cu raises the hazardous voltage flag, it opens the relays and you will have to press Start/Stop on the keypad to re initialize the unit. In case the voltage is still too high, the 6100-Cu will open the relays once again preventing any damage to the equipment. If not, the test will start normally.

To set the buzzer settings:

1. Use the up/down arrow keys to select the desired parameter.
2. Press **✓** on an entry to open the alphanumeric editor screen and use the navigation keys to scroll through.
3. Press **✓** to confirm each value.

7.8 Test Lead Compensation

Test Lead Compensation should be performed when copper test accuracy is in question, since test lead characteristics have some impact on copper test results (mainly resistance, capacitance, and TDR tests). Test lead characteristics vary with respect to cable temperature.

Refer to [Cable Connections](#) on page 8 on how to connect the leads before starting compensation.

The **Test Lead Compensation** routine also performs resistance and capacitance compensation. The page

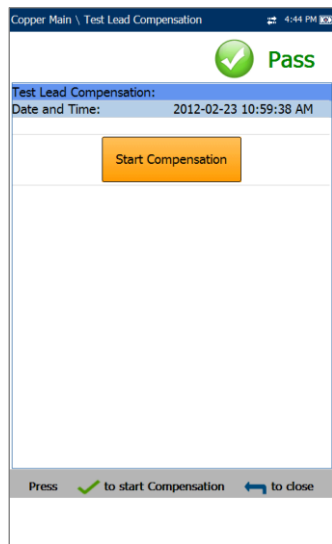

displays the **Pass/Fail** status of the last compensation done.

Note: Always perform a test lead compensation if the test leads have recently been removed or replaced.

- **Date and Time** identifies when the last compensation was done or application installation time.
- **Start Compensation** button allows you to start the **Test Lead Compensation** by overwriting the current test lead characteristics.

To perform a test lead compensation:

1. Connect the cables to the unit, leave all test leads open, and press ✓ to start compensation.
2. Follow the on-screen dialogue boxes for next steps.

7.9 FED Control

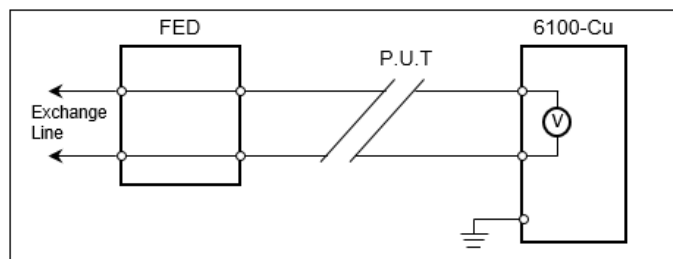

FED Control is an option-enabled feature that tells the test set to detect and control the Teletech TS125 or Viavi UltraFED™ IIB remote FED (far end device) during testing. **Pair Detective**, **Auto Test** and many manual tests will automatically detect and control the FED when this option is enabled, saving you multiple trips to the far end after it is initially placed on the line. The FED should always be connected to ground as well as the P.U.T. (pair under test).

By connecting the T-R-G/A-B-E of a customer's pair (CPE) to the *customer* side of the FED (blue labeled connectors; the red labeled connectors are connected to CO/Exchange side of the pair for pass-through mode), control signals are sent to the FED by the 6100-Cu in order to open/short (or pass through to the CO/Exchange) the T-R-G/A-B-E connections.

Connect T-R-G/A-B-E as follows for each FED state:

1. For **Pass Through/Exchange Connect**, connect the T-R/A-B wires to the blue-labeled Pair1-Cu connectors on the FED (customer

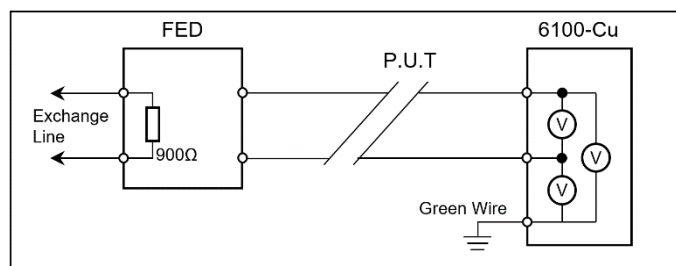

side), and the network side T-R/A-B to the red-labeled Pair1 Ex-CO connectors towards the CO/Exchange.

2. For **Open**, connect the T-R/A-B and ground

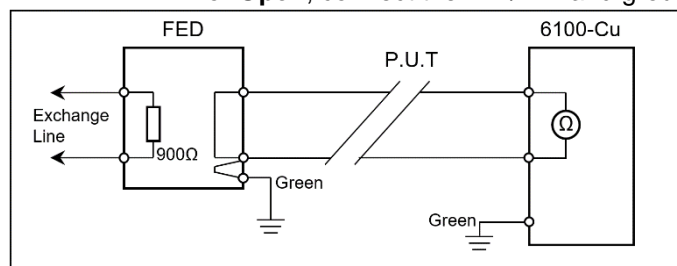

wires to the customer side of the FED (blue labeled connectors).

3. For **T-R-G/A-B-E Shorted**, connect the T-R-G/A-B-E to the customer connectors (blue-labeled Pair1- Cu) and the ground lead to the network ground.

Note: P.U.T., in the above diagrams, refers to the Pair Under Test.

The **FED Control** tab displays the following parameters:

- **FED** sets the default **FED States** to be **Disabled**, **Auto** (automatic), or **Manual** for the following tests. When **Disabled/Auto**, the states are saved in the profile.
 - **Multimeter**
 - **Noise**
 - **Frequency**
 - **Other**

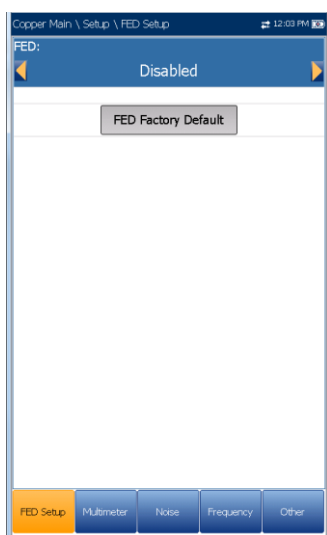

When **FED** is **Auto** or **Manual** and you start a test, the 6100-Cu will warn you if the FED battery level is low. Select **OK** to close the message and run the test. Also, if the FED is not present or not responding, a **Confirmation** dialogue box will be displayed asking if you want to disable FED and run the test anyway.

- **FED Type** is enabled when **FED** is set to **Auto** or **Manual**. If **Auto** is selected, you can choose between **TS125** or **UFED IIB**.

When UFED support is enabled:

- the **Isolation** test voltage source will automatically be limited to 125 V, **Return Loss** test termination to 120 Ω, and **VF/WB Impulse Noise** tests duration to 15 min only.

- **MMT** (maximum measurement time) is determined for every test.

For tests which run in **Continuous** mode, the MMT is set to 20 s allowing you to observe continuous results in numerical or graphical format.

At the end of the MMT, the continuous test is terminated. However, due to UFED limitation, the **Continuous Isolation** resistance test will act the same as the test in **Snapshot** mode and terminate after the **Soak Time** period expires.

If **Manual** is selected, the **FED Type** is set to **TS125** by default. When **FED** is **Manual**, you can set the FED to a desired state independently from the one defined currently in the FED setup for a particular test. This state will be kept indefinitely until you set the FED to

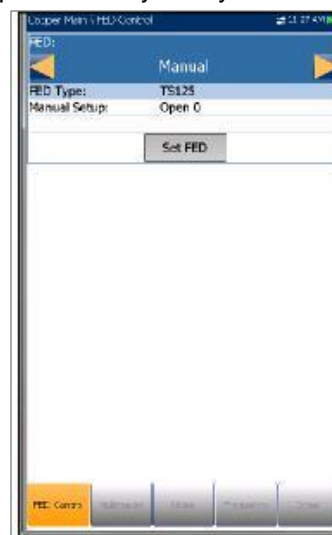

another one, change the mode to **Auto**, or disable the FED.

The **Manual** state of the **FED Control** is not saved in the profile and is only kept for the time of the current session. If you leave the copper application, at next startup FED will be set to the value saved in the profile: **Disabled** or **Auto**.

- **Manual Setup** includes 5 options:
 - Open 0
 - T-R/A-B Shorted 1
 - T-R-G/A-B-E Shorted 2
 - Pass Through/Exchange Connect 3 (default)
 - ID Tone 4

- **Set FED** button activates the state defined in the **Manual Setup** control.
- **Test Status** displays a communication with FED status message.

- **FED Factory Default** button allows you to restore the factory defaults for the following:
 - **Single Test defaults** sets the default FED state values for all the individual tests, except **Auto Test**.
 - **User Auto Test defaults** sets the default FED state values for **Auto Test**.
 - **All these options** sets the default FED state values for all tests.

FED States are displayed in the **Current Test** line as a numeral on the right-hand side of the FED icon, for example . Numerals match the following states:

- 0 = Open
- 1 = T-R/A-B Shorted
- 2 = T-R-G/A-B-E Shorted
- 3 = Pass Through/Exchange Connect
- 4 = ID Tone
- 5 = Terminated (100 Ω, 120 Ω, 135 Ω, 600 Ω)

Note: A line termination of 150 Ω is not supported by the FED.

- 6 = Crosstalk NEXT
- 7 = Transmit
- 8 = None

*Note: For all **FED States** other than **Pass Through/Exchange Connect**, the **Dialer** tab is disabled. If the dialer is already running before the test starts, the dialer will be stopped on entry of the test with a message saying **Dialer cannot be used, hence dialer will be stopped.** - similar to **FaultMapper** test.*

To select the parameter values:

1. Press the up/down arrow keys to highlight the desired parameter.
2. Press the left/right arrow keys to view and select the options.
OR
3. Press  on a value to open a list box of options and press the up/down arrow keys to highlight the desired parameter.

4. Press  to confirm the value.



Multimeter

The **Multimeter** tab lists the default **FED States** set for all multimeter tests, and allows you to set the values for the following:

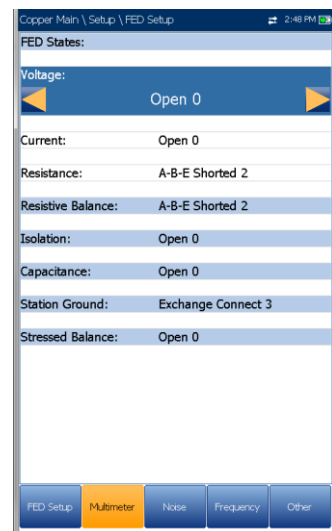
- **Voltage**
- **Current**
- **Resistance**



To select the parameter values:

1. Press the up/down arrow keys to highlight the desired parameter.
2. Press the left/right arrow keys to view and select the options.
OR
3. Press  on a value to open a list box of options and press the up/down arrow keys to highlight the desired parameter.
4. Press  to confirm the value.

Noise

The **Noise** tab allows you to set the **FED States** for all noise tests, and lists the default value for **NEXT** test.

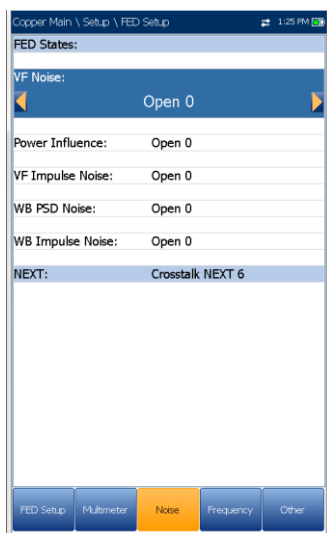

The **Terminated** FED state appends the required resistance value. For example, if you select **Terminated (600 Ω) 5**, the **Termination Resistance** will be 600 ohms.

To select the parameter values:

1. Press the up/down arrow keys to highlight the desired parameter.
 2. Press the left/right arrow keys to view and select the options.
- OR
3. Press ✓ on a value to open a list box of options and press the up/down arrow keys to highlight the desired parameter.
 4. Press ✓ to confirm the value.

Frequency

The **Frequency** tab lists the default **FED States** set for frequency tests and allows you to set the values for the following:

- **VF/AC Balance**
- **WB Balance**
- **Return Loss**

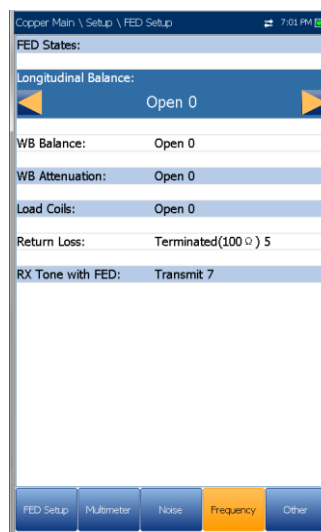

Default values are displayed for **WB Attenuation**, **RX Tone with FED**, and **Load Coils**.

The **Terminated** FED state appends the required resistance value. For example, if you select **Terminated (600 Ω) 5**, the **Termination Resistance** will be 600 ohms.

To select the parameter values:

1. Press the up/down arrow keys to highlight the desired parameter.
 2. Press the left/right arrow keys to view and select the options.
- OR
3. Press ✓ on a value to open a list box of options and press the up/down arrow keys to highlight the desired parameter.
 4. Press ✓ to confirm the value.

Other

The **Other** tab displays the default **FED States** set for all other tests. The **FED States** are listed for the following tests:



- **xTalk TDR**
- **RFL Single/Separate Good Pair/K-Test**
- **Pair Detective**

You can set the default values for the following:

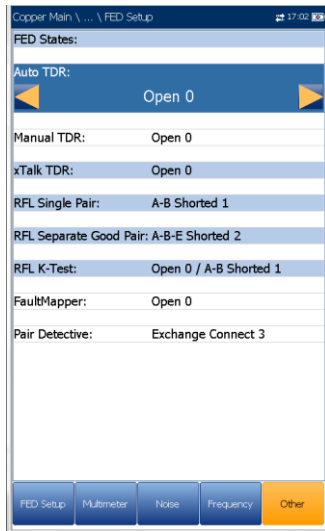
- **Auto/Manual TDR**
- **FaultMapper**



To select the parameter values:

1. Press the up/down arrow keys to highlight the desired parameter.
2. Press the left/right arrow keys to view and select the options.
OR
3. Press  on a value to open a list box of options and press the up/down arrow keys to highlight the desired parameter.
4. Press  to confirm the value.

7.10 Saving Results

Save Result

You can save a snapshot of test results into a result file during or after a test performed with the 6100-Cu. Each copper test includes a **Save Result** tab to do so. The tab allows you to save your test results to an internal memory file or export results to an HTML, MHTML, or XML report using a USB key.

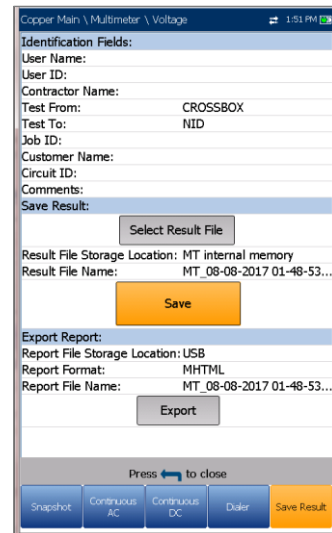

Alternatively, when a test is completed or stopped and you press , **Confirm Save** dialog box pops up. Selecting **Save** displays the **Save Result** screen where the following information can be entered:

- **Identification Fields**
 - **User Name/User ID** display the values set up in the **Application Settings/Identification** tab. You can edit this field using the editor screen.
 - **Contractor Name** allows you to enter the name of a contractor used to perform the tests.
 - **Test From/To** displays the values set up in the **Application Settings/Identification** tab. You can edit this field using the choices from the list box.
 - **Job ID** allows you to create/edit a unique identifier for the task.
 - **Customer Name** is the name of the customer for which the test was run.
 - **Circuit ID** allows you to create/edit a unique identifier for the circuit under test.
 - **Comments** allows you to add any relevant information.
- **Save Result**
 - **Select Result File** button displays a list of existing file names where you can save your results.
 - **Result File Storage Location** gives you the option of storing results either in the 6100-Cu internal memory or USB device. The default selection comes from **Application Settings/General** tab.

- **Result File Name** allows you to preview and edit the result file name. The proposed file name is based on current auto-naming parameters configured in Setup/Application Settings/File Name.
- **Save** button confirms if the **Result File Name** is saved successfully.
- **Export Report**
 - **Report File Storage Location** is set to USB automatically.
 - **Report Format** is **HTML**, **MHTML**, or **XML**.

You can generate and export HTML, MHTML, or XML reports from any saved test result.

Reports include:

General Information including **Pass/Fail** status.

Identification

Profile/Result Summary



Blank entries for your **Signature** and the **Date**.

- **Report File Name** allows you to preview and edit the result file name. The proposed file name is based on current auto-naming parameters configured in Setup/Application Settings/File Name.
- **Export** button confirms if the **Report File Name** is saved successfully. If a USB device is not inserted, the following warning dialogue box appears: **USB device not present**.

To set parameter values and save results:

1. Press the left/right and up/down arrow keys to highlight the desired parameter.
2. Press  to display the list or select the value.
3. Press the up/down arrow key to highlight the desired value.

OR

4. Press the left arrow key to erase the existing value, and then use the alphanumeric keypad to enter a value. To cancel the entry, press .
5. Press  to accept the value.



To save your results to an existing File Name:

1. Use the up/down navigation keys to highlight the desired File Name.
2. Press  to confirm your selection.

Select Result File

Select Result File page displays a list of existing file names where you can save your results.

Section 8 Reading Saved Copper Test Results

8.1 Result Manager

You can view, **Upload**, **Export**, and **Delete** any of your saved results with the 6100-Cu Copper Test Set, by highlighting the **Result Manager** icon from the **Copper Main** pane and pressing 

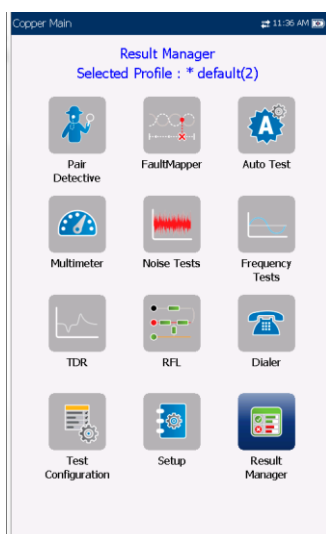

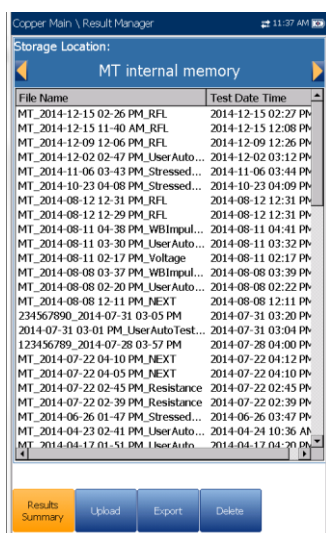

8.2 Results Summary

The **Results Summary** page allows you to select a **File Name** and view the results of files previously saved. The page lists all saved result files by test date and time. The format of Test Date Time is per the selection in System Settings. Result files can be loaded from either the 6100-Cu internal memory or a USB.



To open previously saved test results:

1. Press the left/right arrow keys to highlight the desired Storage Location.
OR
2. Press  to display the list and select the value.
3. Press the down arrow key to highlight the list box and press  to open the list.
4. In the list, press the up/down arrows to select the test results file.
5. Press  to open the result file.

8.3 Result Manager Menu

The **Result Manager** menu allows you to view saved test results with the following details:

- **Summary** displays general information and parameters of the test.
- **Result Details** displays measured results for each lead combination and cable parameters of the test.
- **Profile Details** displays the thresholds and setup parameters of the test.
- **Phone Book** displays the phone entry dialed during the test.
- **FED Details** displays the **FED** (far end device) **State** for the test.

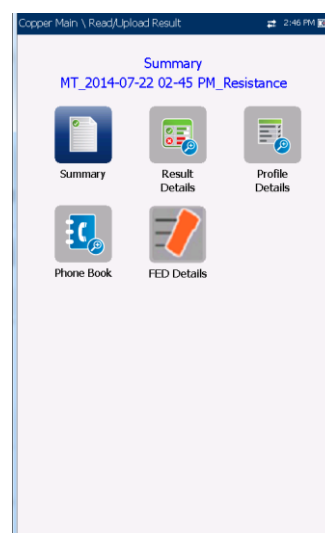

The **File Name** of the selected saved results file is continually displayed at the top of the page.

To navigate the results menu:

1. Press the up/down left/right arrow keys on the keypad to select an icon.
2. Press  to display the results.

Summary

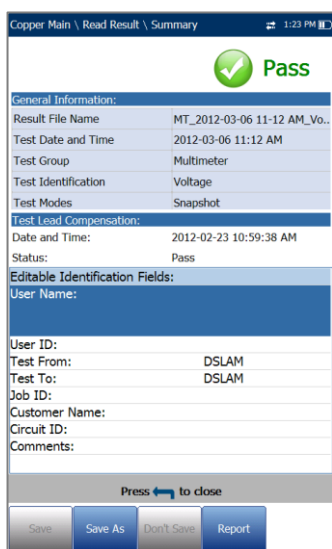

The results **Summary** page displays pass/fail status, general and identification information, along with comments, for the test.



- **General Information** displays read-only information pertaining to the test result.
- **Test Lead Compensation** displays read-only **Date and Time** and **Pass/Fail Status** of the compensated resistance and capacitance based on the cable temperature of the test lead.
- **Editable Identification Fields** display values from the loaded file. You can edit all fields using the editor screen or by selecting an entry from the list box.
 - User Name/ID
 - Contractor Name
 - Test From/To
 - Job ID
 - Customer Name
 - Circuit ID
 - Comments
- Function keys:
 - **Save** keeps any current changes with the current file name.

- **Save As** saves the current changes under a different file name that you can configure in the editor screen.
- **Don't Save** does not save any changes and closes the page.
- **Report** allows you to load a result file to a USB device, update the ID fields, and generate a report in HTML, MHTML, or XML format.
- **Upload** (in User Auto Test only) allows you to transfer an **Auto Test** result file to an FTP site or USB device via the presently selected method (Wi-Fi or Ethernet).

To view and edit the test result information:

1. Press the up/down arrow keys to highlight and view the desired parameter.
2. Press the left/right arrow keys to view and select the options.
OR
3. Press  on an editable value to open the list box of options or the alphanumeric editor screen. Use the navigation keys to scroll through and select.
4. Press  to confirm the value.

Result Details

The **Results Details** page allows you to view measured results for each lead combination and cable parameters of the selected test.

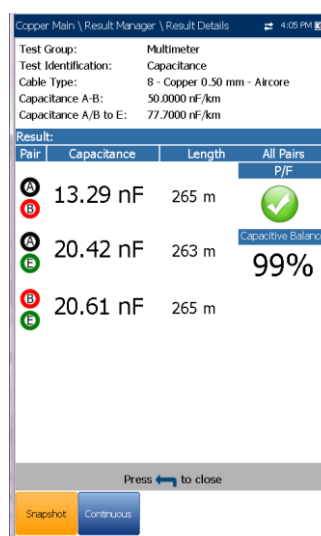

Profile Details

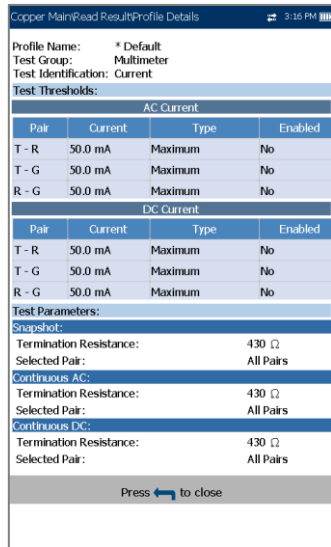

The **Profile Details** page displays read-only test thresholds and/or parameters information about the setup of the selected test, and may contain the following entries:

- **Profile Name** (only displayed in **Results Manager**) is the file name of the selected saved results.
- **Test Group** is the overall test group of the selected saved results file, for example **Multimeter**.
- **Test Identification** is the test type of the group, for example **Current**.

Phone Book

The **Phone Book** page summarizes the Phone Book details when loading a results file.

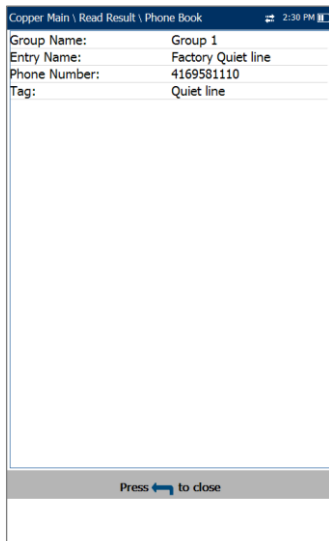

It contains information about group entries such as group ID, name, phone numbers, and tags.

If the dialer was not used during the test, the **Phone Book** icon will not appear as part of the **Read Result** menu page.

FED Details

The **FED Details** page displays the default FED state **Value** set for the test(s).





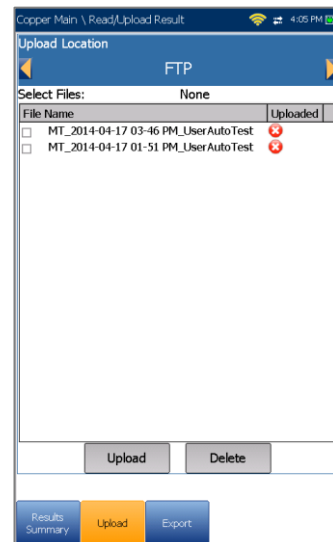

8.4 Upload

The **Upload** page allows you to upload the saved results of User Auto tests only to an FTP site, or a USB memory stick. Select a **File Name** or **All** files previously saved. Files are uploaded via the selected method (Wi-Fi or Ethernet) as shown by the corresponding icon in the top right-hand corner of the navigation bar.



- **Upload Location** is **FTP**, or **USB**.
- **Select Files** is either **None** which removes all check marks allowing you to select one or more files, or **All**.
- **Uploaded** status column displays a successful, failed, or no upload for each file.
- **Upload** button transfers the selected files to the designated location.
- **Delete** button removes selected XML files from the internal memory.

To upload previously saved User Auto Test results:

1. Press the left/right arrow keys to highlight the desired **Upload Location**.
OR
2. Press  to display the list and select the value.
3. Press the down arrow key and select either **None** or **All** files.
4. If **None**, press the down arrow key to highlight the list box and press  to open the list.
5. In the list, press the up/down arrows to select the desired files.
6. Press  to come out of the list.
7. Press the down arrow key to highlight either **Upload** or **Delete** and press .

8.5 Export

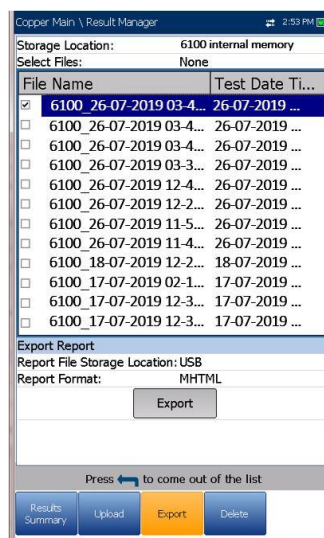

If you have saved a number of test results in the test set, you can export them (convert to another file format such as MHTML or XML) all at once to a USB stick when you have time, or save them to a USB stick anytime on the job.

The **Export** page allows you to select a **File Name** or **All** files previously saved and export the results in a selected **Report Format**.



- **Storage Location** gives you the option of exporting your results to either the **6100-Cu internal memory** or **USB** device.
- **Select Files** is either **None** or **All**. **None** removes all check marks allowing you to select one or more files, or **All**.
- **Export Report**
 - **Report File Storage Location** is set to USB automatically.
 - Report Format is HTML, MHTML, or XML.
 - **Export** button transfers the selected file(s) to the internal memory or USB device in the selected report format.

To export previously saved test results:

1. Press the left/right arrow keys to highlight the desired Storage Location.
OR
2. Press  to display the list and select the value.
3. Press the down arrow key and select either **None** or **All** files.
4. If **None**, press the down arrow key to highlight the list box and press  to open the list.
5. In the list, press the up/down arrows to select the desired files.
6. Press  to come out of the list.
7. Press the down arrow key to highlight the **Report Format**.
8. Press the left/right arrow keys to select the desired format.
OR

9. Press  to display the list and select the value.
10. Press the down arrow key to press the **Export** button.

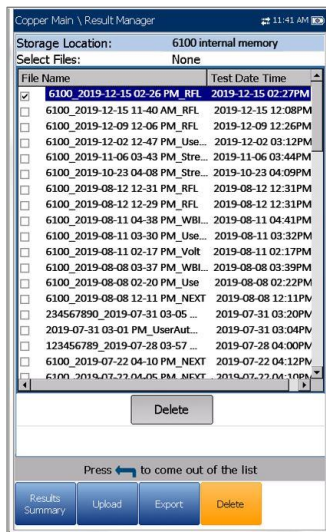

8.6 Delete

The **Delete** page allows you to delete a selected **File Name** or **All** selected result files previously saved in the **6100-Cu internal memory** only.



- Storage Location is the **6100-Cu** internal memory.
- **Select Files** is either **None** or **All**. **None** removes all check marks allowing you to select one or more files, or **All**.
- **Delete** button removes the selected files.

To delete previously saved test results:

1. Press the left/right arrow keys and then  to select either **None** or **All** files.
2. If **None**, press the down arrow key to highlight the list box and press  to open the list.
3. In the list, press the up/down arrows to select the desired files.
4. Press  to come out of the list.
5. Press the down arrow key to press the **Delete** button.
6. Press **Delete** to confirm your selection or **Cancel** to abort the operation.

Section 9 Multimeter Tests

The purpose of the **Multimeter** tests function is to detect AC/DC voltages and currents, measure resistance and capacitance in a loop, and *stress test* the loop.

To access Multimeter tests:

From the **Copper Main** pane, highlight **Multimeter** and press  to open the **Multimeter** menu.

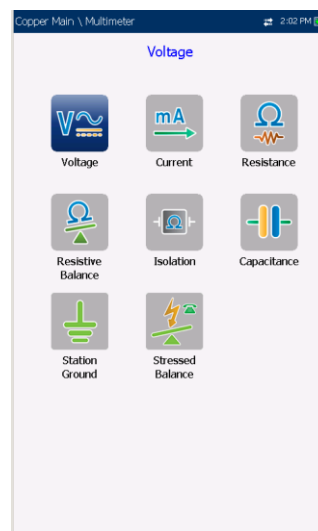



9.1 Multimeter Main Page

Multimeter tests allow you to do the following:

- make basic electrical safety checks (AC volts)
- check for *crossed* or coupled battery voltages
- assess basic loop continuity
- balance loop quality with resistance measurements
- measure total electrical length with capacitance
- measure the ground path resistance with the station ground test
- run a *stress* test.

Pair Detective runs many of these tests automatically and is a recommended starting test to assess loop quality and identify common faults.

To access Pair Detective from Multimeter tests:

1. Press  to return to the **Copper Main** menu.
2. Highlight Pair Detective and press  to launch the test.

The **Multimeter** menu allows you to select and run the displayed tests:

- **Voltage**
- **Current**
- **Resistance**
- **Resistive Balance**
- **Isolation**
- **Capacitance/Opens**
- **Station Ground**
- **Stressed Balance**
- **Dialer** (icon shown here if FED or UFED enabled; see [Dialer Function](#) on page 30 for details.)

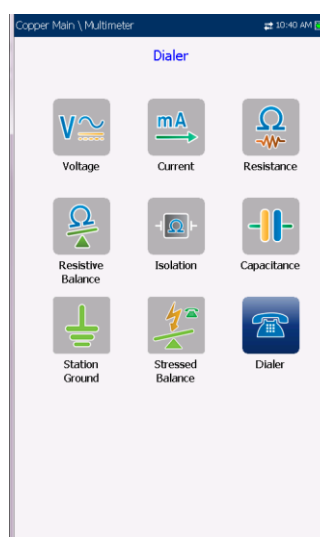

To start/stop a test:

1. Press the up/down left/right arrow keys on the keypad to select the desired test icon.
2. Press  to confirm your selection.
3. The test will start automatically if the **Setup/Application Settings - Test Startup Mode** is set to **Auto**. If not, press **Start/Stop** on the keypad.

9.2 Voltage

The **Voltage** test detects AC RMS and DC voltages in the line and allows you to measure AC/DC voltages and **Frequency** on A/B/E or T/R/G depending on the selected **Standard** in **Setup/Application Settings**.

Voltage tests are not meant, nor is the test set rated, to measure electrical power circuits.

Continuous DC Page

With voltage measurements, you can detect crossed battery, other foreign unwanted voltages, and even see intermittent breaks or contact if the voltages fluctuate.

Most plant operators allow 3 or 4 volts of DC and/or AC signal on working loops, although for higher speed broadband circuits (ADSL2+ or VDSL2), even a few volts indicate a small fault and some imbalance which may affect the data rate. You would need to run balance tests such as **Stressed Balance**, **VF/AC Balance**, and/or short the far end and run **Resistive Balance** to isolate small faults.

Larger foreign/unwanted voltages are a real problem because they indicate a contact fault and add unwanted noise affecting other signals (including affecting test set signals). 48 to 52 volts would indicate working POTS. If you have not already done so, press  and select **Pair Detective** to identify metallic faults or even wetness.

The **Voltage** test defaults to the **Continuous DC** page from the **Multimeter** menu. This function measures each pair, displaying and updating results in real time, until you stop the test. The last valid results then remain displayed. If the DC value is fluctuating, it could indicate the presence of moisture in a fault or possibly a moving or swinging metallic fault, causing intermittent breaks in the DC (such as POTS battery).

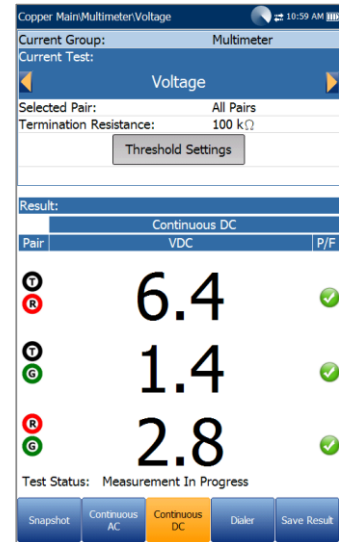

To view all lead combinations right away:

- Press the **Snapshot** function key.



Continuous AC and **Continuous DC** are run synchronously. Press Start/Stop on the keypad to run the test.

- **Current Group** is the current test group name, for example **Multimeter**.
- **Current Test** displays the test being measured. Here you can switch to another test from the given list. However, this action will terminate the ongoing measurement test.
- **Selected Pair** allows you to select **All Pairs** or a single wire pair for measurement.
- **Termination Resistance** defines how much resistance the tester uses to connect to the line and measure voltages.
- **Threshold Settings** button opens a new page that allows you to set the DC voltage thresholds for each pair.
- **Result** displays a snapshot of the pass/fail status and volts for each continuous DC pair.
- **Test Status** displays the current state of measurement or an error message.

To select the parameter values:

1. Press the up/down arrow keys to highlight the desired parameter.
2. Press the left/right arrow keys to view and select the options.

OR

3. Press  on a value to open a list box of options.
4. Press  to confirm the value.

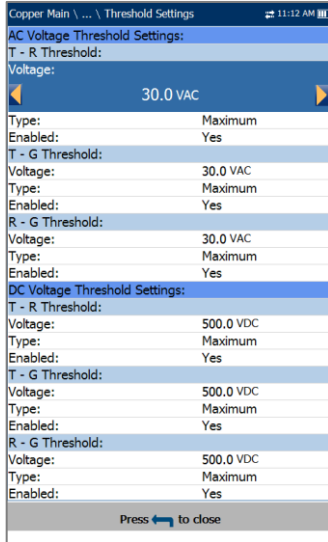

Voltage Thresholds

The **AC/DC Voltage Threshold Settings** page allows you to set the **Threshold Voltage** for each pair. The threshold is a programmable value you can use as an on-screen indicator in each test when a measured value is too high or too low.



- **Type** is the threshold limit for each pair: either **Maximum** or **Minimum**.
- **Enabled** is a flag to use the voltage threshold: either **Yes** or **No**.

To set threshold values:

1. Press the up/down arrow keys to highlight the desired parameter.
2. Press the left/right arrow keys to view and select the options.
OR
3. Press  on a value to open a list box of options or the alphanumeric editor screen and use the navigation keys to scroll through.
4. Press  to confirm the value.

Continuous AC Page

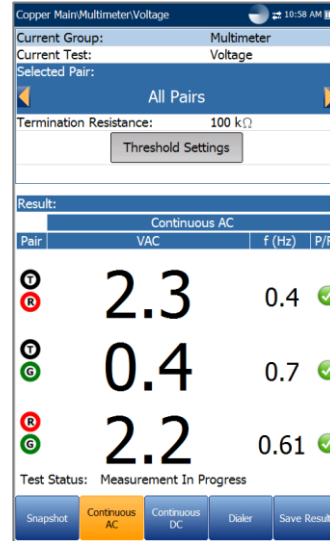

The **Continuous AC** function measures each pair, displaying and updating results in real time, until you stop the test. The last valid results then remain displayed. The Voltage test defaults to the Continuous DC page from the Multimeter menu.

Continuous AC and **Continuous DC** are run synchronously. Press Start/Stop on the keypad to run the test.



- **Current Group** is the current test group name, for example **Multimeter**.
- **Current Test** displays the test being measured. Here you can switch to another test from the given list. However, this action will terminate the ongoing measurement test.
- **Selected Pair** allows you to select **All Pairs** or a single wire pair for measurement.
- **Termination Resistance** defines how much resistance the tester uses to connect to the line and measure voltages.
- **Threshold Settings** button opens a new page that allows you to set the AC voltage thresholds for each pair.
- **Result** displays a snapshot of the pass/fail status, volts and frequency (Hz) values for each continuous AC pair.
- **Test Status** displays the current state of measurement or an error message.

To select the parameter values:

1. Press the up/down arrow keys to highlight the desired parameter.
2. Press the left/right arrow keys to view and select the options.
OR
3. Press  on a value to open a list box of options.
4. Press  to confirm the value.

Snapshot

The voltage **Snapshot** tab shows measured volts for each lead combination.

Copper Main/Multimeter/Voltage					
Current Group:		Multimeter			
Current Test:		Voltage			
Selected Pair:		All Pairs			
Termination Resistance:		100 k Ω			
Threshold Settings					
Result:					
Pair	Snapshot DC		Snapshot AC		
	VDC	P/F	VAC	f (Hz)	P/F
	4.9		2.3	1.1	
	3.6		2.7	2.1	
	2.2		0.9	2.3	
Test Status: Measurement completed					
Snapshot Continuous AC Continuous DC Dialer Save Result					

The parameters are as follows:

- **Current Group** is the current test group name, for example **Multimeter**.
- **Current Test** displays the test being measured. Here you can switch to another test from the given list. However, this action will terminate the ongoing measurement test.
- **Selected Pair** allows you to select **All Pairs** or a single wire pair for measurement.
- **Termination Resistance** defines how much resistance the tester uses to connect to the line and measure voltages. The default value of 100 k Ω is widely used in the industry.
- **Threshold Settings** button opens a new page that allows you to set the AC/DC voltage thresholds for each pair.
- **Result** displays a snapshot of the pass/fail status, volts and frequency (Hz) values for each continuous AC/DC pair.
- **Test Status** displays the current state of measurement or an error message.

To select the parameter values:

1. Press the up/down arrow keys to highlight the desired parameter.
2. Press the left/right arrow keys to view and select the options.
OR
3. Press on a value to open a list box of options.
4. Press to confirm the value.

9.3 Current

The **Current** test allows you to measure the AC/DC currents and frequency in the loop. DSL service does not directly use this measurement.

Snapshot

The current **Snapshot** shows measured AC/DC results for each lead combination. DC current is traditionally measured for POTS/voice with a minimum of 23 mA, but less DC current can indicate line faults or too much loss. The Current test defaults to the **Continuous DC** page from the **Multimeter** menu.

Copper Main/Multimeter/Current					
Current Group:		Multimeter			
Current Test:		Current			
Selected Pair:		All Pairs			
Termination Resistance:		430 Ω			
Threshold Settings					
Result:					
Pair	Snapshot DC		Snapshot AC		
	DC (mA)	P/F	AC (mA)	f (Hz)	P/F
	8.5		5.0	6.7	
	4.5		0.3	7.7	
	0.7		0.4	7.1	
Test Status: Measurement completed					
Snapshot Continuous AC Continuous DC Dialer Save Result					



The parameters are as follows:

- **Current Group** is the current test group name, for example **Multimeter**.
- **Current Test** displays the test being measured. Here you can switch to another test from the given list. However, this action will terminate the ongoing measurement test.
- **Selected Pair** allows you to select **All Pairs** or a single wire pair for measurement.
- **Termination Resistance** is a read-only value of 430 Ω that defines how much resistance the tester uses to connect to the line.
- **Threshold Settings** button opens a new page that allows you to set the AC/DC current thresholds for each pair.
- **Result** displays a snapshot of the pass/fail status, DC current, AC current and frequency (Hz) results for each selected wire pair.
- **Test Status** displays the current state of measurement or an error message.

To select the parameter values:

1. Press the up/down arrow keys to highlight the desired parameter.
2. Press the left/right arrow keys to view and select the options.

OR

3. Press  on a value to open a list box of options.
4. Press  to confirm the value.

Current Thresholds

The **AC/DC Current Threshold Settings** page allows you to set the **Current** threshold for each pair. The threshold is a programmable value you can use as an on-screen indicator in each test when a measured value is too high or too low.

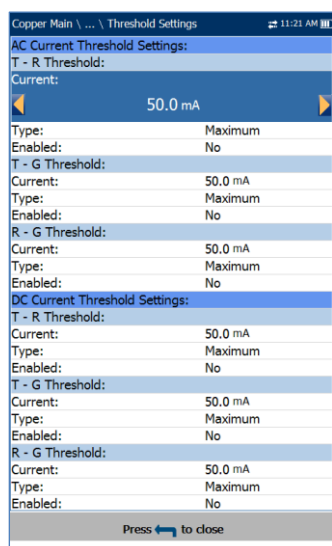



- **Type** is the threshold limit for each pair: either **Maximum** or **Minimum**.
- **Enabled** is a flag to use the current threshold: either **Yes** or **No**.

To set threshold values:

1. Press the up/down arrow keys to highlight the desired parameter.
2. Press the left/right arrow keys to view and select the options.

OR

3. Press  on a value to open a list box of options or the alphanumeric editor screen and use the navigation keys to scroll through.
4. Press  to confirm the value.

Continuous AC Page

The **Continuous AC** function measures each pair, displaying and updating results in real time, until you stop the test. The last valid results then remain displayed. The **Current** test defaults to the **Continuous DC** page from the **Multimeter** menu. Continuous AC and Continuous DC are run synchronously. Press Start/Stop on the keypad to run the test.

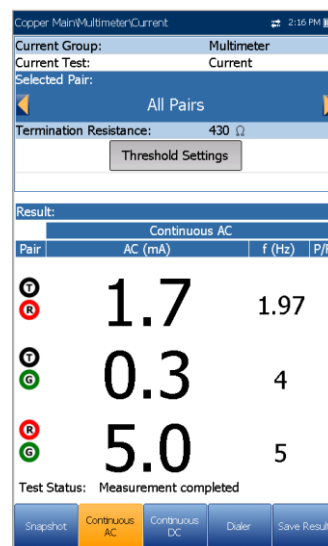



- **Current Group** is the current test group name, for example **Multimeter**.
- **Current Test** displays the test being measured. Here you can switch to another test from the given list. However, this action will terminate the ongoing measurement test.
- **Selected Pair** allows you to select **All Pairs** or a single wire pair for measurement.
- **Termination Resistance** is a read-only value of **430 Ω** that defines how much resistance the tester uses to connect to the line.
- **Threshold Settings** button opens a new page that allows you to set the AC current thresholds for each pair.
- **Result** displays a snapshot of the pass/fail status, AC current and frequency (Hz) results for each selected wire pair.
- **Test Status** displays the current state of measurement or an error message.

To select the parameter values:

1. Press the up/down arrow keys to highlight the desired parameter.
2. Press the left/right arrow keys to view and select the options.

OR

3. Press  on a value to open a list box of options.
4. Press  to confirm the value.

Continuous DC Page

The **Continuous DC** function measures each pair, displaying and updating results in *real time*, until you stop the test. The last valid results then remain displayed. Significant fluctuations while this test is running can indicate intermittent *swinging*, contact or wet faults.

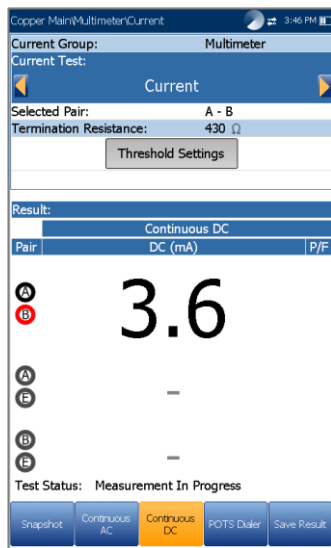

To view all lead combinations right away:



- Press the **Snapshot** function key.

Continuous AC and **Continuous DC** are run synchronously. Press Start/Stop on the keypad to run the test.

- **Current Group** is the current test group name, for example **Multimeter**.
- **Current Test** displays the test being measured. Here you can switch to another test from the given list. However, this action will terminate the ongoing measurement test.
- **Selected Pair** allows you to select **All Pairs** or a single wire pair for measurement.
- **Termination Resistance** is a read-only value of **430 Ω** that defines how much resistance the tester uses to connect to the line.
- **Threshold Settings** button opens a new page that allows you to set the DC current thresholds for each pair.
- **Result** displays a snapshot of the pass/fail status and DC current results for each selected wire pair.

- **Test Status** displays the current state of measurement or an error message.

To select the parameter values:

1. Press the up/down arrow keys to highlight the desired parameter.
2. Press the left/right arrow keys to view and select the options.
OR
3. Press  on a value to open a list box of options.
4. Press  to confirm the value.

9.4 Resistance

The **Resistance** test, also known as shorts, allows you to measure the resistance values in Ohms, of the wire pair under test. Use this test to identify shorts and grounds when the far end is open, comparing the Ohms reading of each lead combination. You want high-Ohm values between the leads when measuring to an open, the higher the better. But if a reading is very low, such as 200 kΩ T-G/A-E, we know there is a ground fault present.



It is also valuable to apply a short across T/A-R/B at the far end, and then measure the round trip *loop* resistance, in which case you will see that low values with the far-end short are applied ($\leq 2500 \Omega$, depending on loop length and condition). It is even more valuable to run the resistance balance test when the far end is shorted, as the test will calculate the resistance in ohms of each side/leg of the pair, so you may see the difference, in effect the balance.

Significant differences indicate one-sided faults or series resistance and/or high resistive partial opens. Typical values for POTS circuits are 1 to 3.5 MΩ across each lead combination, whereas pairs for broadband DSL should be at least 5 MΩ; and for higher speed broadband circuits, > 20 MΩ is recommended.

Resistance values are valuable when the far end is shorted and grounded (all leads). We can get an accurate Ohms value for each lead/leg independent of the other and compare them (resistance balance), looking for a different Ohms value on one side versus the other, indicating series or one-sided faults/imbalances sometimes also called partial *dirty* or high resistive opens. These can be difficult to locate, as they are not clearly a ground fault, but RFL would be the primary way to locate a one-sided series fault. In

some cases, a TDR may reflect off such a fault but then again, may not. Try TDR first, but be prepared to try RFL if you really need this pair in service for a high-speed broadband.

To select either TDR or RFL tests:

1. Press  to return to the Copper Main menu.
2. Highlight TDR or RFL and press  to launch the test.

Snapshot

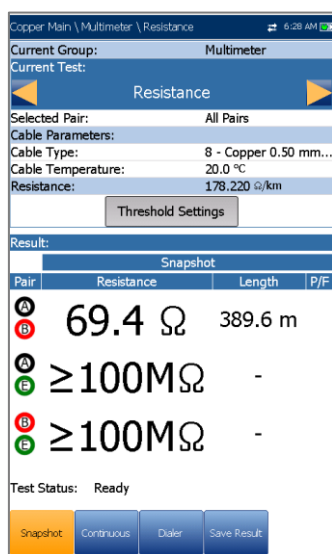



The resistance **Snapshot** shows measured resistance values in Ohms and cable lengths for each lead combination. The parameters are as follows:

- **Current Group** is the current test group name, for example **Multimeter**.
- **Current Test** displays the test being measured. When FED is **Enabled**, the FED icon and numeric state are displayed beside the **Current Test**. Here you can switch to another test from the given list. However, this action will terminate the ongoing measurement test.
- **Selected Pair** allows you to select **All Pairs** or a single wire pair for measurement.
- **Cable Parameters:**
 - **Cable Type** displays the ID, Cable Name and Fill, and allows you to select an entry (with its associated parameters) from the current Cable Book, to use for testing. The selection is not saved when leaving the test. The current Cable Book entry is shown by default.

- **Cable Temperature** is the temperature in either °F or °C of the cable under test.

- **Resistance** displays the resistance per length constant of the selected **Cable Type**. The value is updated when **Cable Temperature/Type** is changed.
- **Threshold Settings** button opens a new page that allows you to set resistance thresholds for each pair.
- **Result** displays a snapshot of the pass/fail status, **Resistance** and **Length** for each selected wire pair.
- **Test Status** displays the current state of measurement or an error message.

To select the parameter values:

1. Press the up/down arrow keys to highlight the desired parameter.
2. Press the left/right arrow keys to view and select the options.
OR
3. Press  on a value to open a list box of options.
4. Press  to confirm the value.

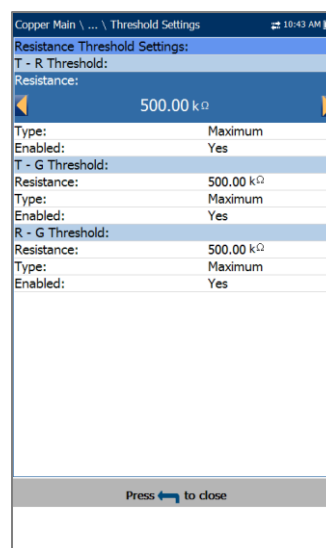

Resistance Thresholds

The **Resistance Threshold Settings** page allows you to set the Resistance for each pair. The threshold is a programmable value you can use as an on-screen indicator in each test when a measured value is too high or too low.



- **Type** is the threshold limit for each pair: either **Maximum** or **Minimum**.
- **Enabled** is a flag to use the current threshold: either **Yes** or **No**.

To set threshold values:

1. Press the up/down arrow keys to highlight the desired parameter.
2. Press the left/right arrow keys to view and select the options.
OR
3. Press  on a value to open a list box of options or the alphanumeric editor screen and use the navigation keys to scroll through.
4. Press  to confirm the value.

Continuous

The **Continuous** function measures each pair, displaying and updating results in *real time*, until you stop the test. The last valid results then remain displayed. In **Continuous** mode, significant changes or fluctuations in the values can indicate wet faults or intermittent metallic faults (*swinging* faults), or other foreign voltages on the pair. (Sometimes ground signals can influence a pair through a ground fault.)

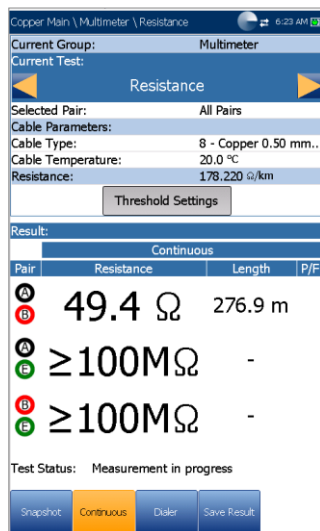



- **Current Group** is the current test group name, for example **Multimeter**.
- **Current Test** displays the test being measured. When FED is **Enabled**, the FED icon and numeric state are displayed beside the **Current Test**.

Here you can switch to another test from the given list. However, this action will terminate the ongoing measurement test.

- **Selected Pair** allows you to select **All Pairs** or a single wire pair for measurement.
- **Cable Parameters:**
 - **Cable Type** displays the ID, Cable Name and Fill, and allows you to select an entry (with its associated parameters) from the current Cable Book, to use for testing. The selection is not saved when leaving the test. The current Cable Book entry is shown by default.
 - **Cable Temperature** is the temperature in either °F or °C of the cable under test.
- **Resistance** displays the resistance per length value of the selected **Cable Type**. The value is updated when **Cable Temperature/Type** change.
- **Threshold Settings** button opens a new page that allows you to set the resistance thresholds for each pair.
- **Result** displays a snapshot of the pass/fail status, **Continuous Resistance** and **Length** for each selected wire pair.
- **Test Status** displays the current state of measurement or an error message.

To select the parameter values:

1. Press the up/down arrow keys to highlight the desired parameter.
2. Press the left/right arrow keys to view and select the options.
OR
3. Press  on a value to open a list box of options or the alphanumeric editor screen and use the navigation keys to scroll through.
4. Press  to confirm the value.

9.5 Resistive Balance

The **Resistive Balance** test measures and compares the resistance of each leg. This test requires you to short Tip and Ring (T-R/A-B) to ground/earth at the far end (T-R-G/A-B-E short) before proceeding with the test. Radiodetection's TS-125 FED (Far End Device) can automatically set the far end condition.

Snapshot

The **Resistive Balance** test is valuable in understanding the presence of resistive faults on one side versus the other (series resistance). A 5 % difference in the Ohms value between T/A and R/B is common (95 % balance), but for higher speed DSL such as VDSL2, imbalance is more critical and should be 2-3 % when possible (97-98 % balance). There will be low-Ohm values when measuring resistance with a short at the far end.

For example, on 24 AWG cable at 21 °C (70 °F), you will see 520 Ω for a 3 m (10 ft) cable. If both Tip and Ring have 520 Ω, the pair is balanced perfectly, but there will normally be some small difference and a much larger value on one side, for example, 800 Ω indicates a significant series fault on that side.

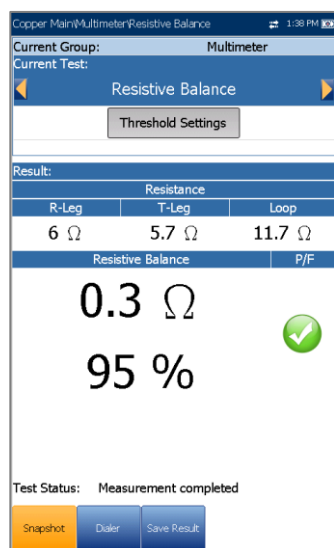

The resistive balance **Snapshot** shows results for **R/B-Leg**, **T/A-Leg**, **Loop** resistance, and the pass/fail status for **Resistive Balance** in Ω and %.



Parameters are as follows:

- **Current Group** is the current test group name, for example **Multimeter**.
- **Current Test** displays the test being measured. When FED is **Enabled**, the FED icon and numeric state are displayed beside the **Current Test**. Here you can switch to another test from the given list. However, this action will terminate the ongoing measurement test
- **Threshold Settings** button opens a new page that allows you to set the resistive balance thresholds.
- **Test Status** displays the current state of measurement or an error message.

To select the parameter values:

1. Press the up/down arrow keys to highlight the desired parameter.
2. Press the left/right arrow keys to view and select the options.
OR
3. Press  on a value to open a list box of options.
4. Press  to confirm the value.

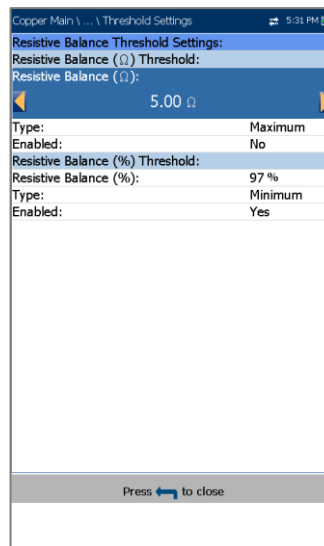

Resistive Balance Threshold Settings

The **Threshold Settings** page allows you to set the **Resistive Balance (Ω) Threshold** values. The threshold is a programmable value you can use as an on-screen indicator in each test when a measured value is too high or too low.



- **Type** is the threshold limit for each pair: either **Maximum** or **Minimum**.
- **Enabled** is a flag to use the current threshold: either **Yes** or **No**.

To set threshold values:

1. Press the up/down arrow keys to highlight the desired parameter.
2. Press the left/right arrow keys to view and select the options.
OR
3. Press  on a value to open a list box of options or the alphanumeric editor screen and use the navigation keys to scroll through.
4. Press  to confirm the value.

Result Details

The **Results Details** read-only page displays the **Resistance** results for each lead combination and the pass/fail status for **Resistive Balance** in Ω and %.

Resistance		
R-Leg	T-Leg	Loop
6 Ω	5.7 Ω	11.7 Ω
Resistive Balance		P/F
0.3 Ω		✓
95 %		

Press ← to close

Profile Details

Test Thresholds:		
Resistive Balance		
Resistive Balance	Type	Enabled
5.00 Ω	Maximum	Yes
Resistive Balance	Type	Enabled
60 %	Minimum	Yes

Press ← to close

The **Profile Details** page displays read-only **Resistive Balance** thresholds.

- **Profile Name** is the file name of the selected saved results.
- **Test Group** is the overall test group of the selected saved results file, for example **Multimeter**.
- **Test Identification** is the test type of the group, for example **Resistive Balance**.

9.6 Isolation

The **Isolation** test, also known as a leakage test, is a type of resistance test run over a period of time to look for high-resistive faults. This test applies more measuring voltage than standard resistance tests (typically 100 VDC) over a longer period of time or **Soak Time**.

The purpose is to allow the applied higher voltage to leak through corrosion or high resistive faults, revealing the fault by the drop in the measured resistance value. Standard resistance tests use lower voltages (15 to 45 V) only for a short period of time.

Snapshot

The **Isolation** (also known as insulation resistance) test shows how the pair insulation (that is PIC or paper, pulp, etc.) may be lower because of long-term voltage on the pair under test. (Remember that telecom signals are full time.) This is especially important for power span pairs carrying significant voltages over time. Be aware that the continuous application of a voltage tends to dry up moisture, and some faults may seem to disappear. (You would see the resistance value increase and thus improve as the test progresses; however, the cause of the moisture is not resolved.)

Note: The test should be run with an open circuit at the far end.

Snapshot			
Pair	Resistance	Soak Counter (s)	P/F
T-R	≥ 1 G Ω	3	✓
T-R-G	≥ 1 G Ω	3	✓
R-G	≥ 1 G Ω	3	✓

Test Status: Ready

Buttons: Snapshot, Continuous, Dialer, Save Result

The **Snapshot** page shows measured isolation resistance values for each lead combination. The parameters are as follows:



- **Current Group** is the current test group name, for example **Multimeter**.

- **Current Test** displays the test being measured. Here you can switch to another test from the given list. However, this action will terminate the ongoing measurement test.
- **Selected Pair** allows you to select **All Pairs** or a single wire pair for measurement.
- **Soak Voltage** allows you to apply a voltage value to the pair(s) currently under test. If your unit has the HIVOLT (high voltage) software option configured, the **Soak Voltage** parameter values are extended up to 500 V max.

*Note: Since **Soak Voltage** is inherited in other tests that use the Isolation test, the HIVOLT software option also applies to the following tests: **Pair Detective** and **User Auto Test**.*

- **Soak Time** sets a soak period of time from 1 to 60 seconds.
- **Threshold Settings** button opens a new page that allows you to set isolation thresholds for each pair.
- **Result** displays a snapshot of the pass/fail status, **Resistance** and a **Soak Counter** for each selected wire pair. When running the test, the counter counts to the selected Soak Time by the second, for the wire pair(s) under test.
- **Test Status** displays the current state of measurement or an error message.

To select the parameter values:

1. Press the up/down arrow keys to highlight the desired parameter.
2. Press the left/right arrow keys to view and select the options.
OR
3. Press  on a value to open a list box of options or the alphanumeric editor screen and use the navigation keys to scroll through.
4. Press  to confirm the value.

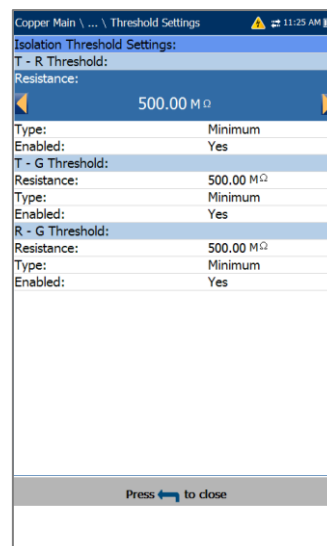

Isolation Thresholds

The **Isolation Threshold Settings** page allows you to set the Resistance threshold values for each pair. The threshold is a programmable value you can use as an on-screen indicator in each test when a measured value is too high or too low.



- **Type** is the threshold limit for each pair: either **Maximum** or **Minimum**.
- **Enabled** is a flag to use the voltage threshold: either **Yes** or **No**.

To set threshold values:

1. Press the up/down arrow keys to highlight the desired parameter.
2. Press the left/right arrow keys to view and select the options.
OR
3. Press  on a value to open a list box of options or the alphanumeric editor screen and use the navigation keys to scroll through.
4. Press  to confirm the value.

Continuous

The **Continuous** function measures each pair, displaying and updating results in *real time*, until you stop the test. The last valid results then remain displayed. Remember that the continuous application of a higher voltage tends to dry up moisture in faults, making it seem as if they have disappeared; but only the moisture is gone and will likely reappear another time.

Note: The test should be run with an open circuit at the far end.

*Note: If **UFED Control** option is enabled, due to its limitation, the **Continuous** function will act the same as the test in **Snapshot** mode and terminate after the **Soak Time** period expires.*

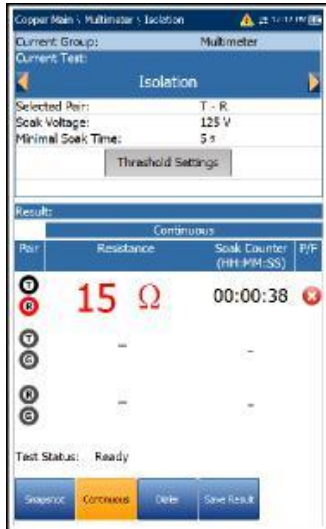

- **Current Group** is the current test group name, for example **Multimeter**.
- **Current Test** displays the test being measured. Here you can switch to another test from the given list. However, this action will terminate the ongoing measurement test.
- **Selected Pair** allows you to select a single wire pair for measurement.
- **Soak Voltage** allows you to apply a voltage value to the pair(s) currently under test. If your unit has the HIVOLT (high voltage) software option configured, the **Soak Voltage** parameter values are extended up to 500 V maximum.

*Note: Since **Soak Voltage** is inherited in other tests that use the **Isolation** test, the HIVOLT software option also applies to the following tests: **Pair Detective** and **User Auto Test**.*

- **Minimal Soak Time** sets a soak period of time from 1 to 60 seconds. When the test duration reaches the **Minimal Soak Time**, the pass/fail status is displayed and then periodically refreshed, until you stop the test.
- **Threshold Settings** button opens a new page that allows you to set isolation thresholds for each pair.
- **Result** displays a snapshot of the pass/fail status, **Resistance** and a **Soak Counter** for each selected wire pair. While running the test, the counter displays the soak period by the second, for the wire pair(s) under test.
- **Test Status** displays the current state of measurement or an error message.

To select the parameter values:

1. Press the up/down arrow keys to highlight the desired parameter.
2. Press the left/right arrow keys to view and select the options.
OR
3. Press ✓ on a value to open a list box of options or the alphanumeric editor screen and use the navigation keys to scroll through.
4. Press ✓ to confirm the value.

9.7 Capacitance/Opens

The **Capacitance/Opens** test measures the electrical capacitance of the loop and calculates length. Capacitive balance is also measured when all pairs are selected.

Snapshot

The **Capacitance/Opens** test should be run with the far end open, as electronics and equipment will skew or change the values. DSL splitters also add some capacitance and change the values, as do some NIDs and filtered wall plates.

The test gives you a quick indication of the length, to help you see if the loop is too short and has an open. The capacitive balance is key and should typically be 95 % (5 % imbalance) for POTS/internet, and better for high speed broadband such as VDSL2. If the opens distance is significantly less than indicated on plant maps, then the pair may be open at the distance suggested. (Of course, if the distance matches the expected length, you are seeing the end.)



Be a bit cautious with capacitance/opens, as wet faults or physical damage can significantly change the result. Wetness can provide a path to ground or other pairs which are then also included in the capacitance value and not just the pair under test. Opens can usually be located using a TDR.

To access TDR from Multimeter tests:

1. Press ← to return to the **Copper Main** menu.
2. Highlight **TDR** and press ✓ to open the **TDR** menu.
3. Select either **Auto TDR** or **Manual TDR** to run the test. **Auto TDR** will attempt to locate the nearest large event/reflection which may or may not be the open.

TDR can also be run from **Pair Detective**.

To access Pair Detective from Multimeter tests:

1. Press  to return to the **Copper Main** menu.
2. Highlight **Pair Detective** and press  to launch the test.

See [TDR](#) on page 117 for more help on using this test.



The **Snapshot** page shows measured **Capacitance** values and **Length** for each lead combination. The parameters are as follows:

- **Current Group** is the current test group name, for example **Multimeter**.
- **Current Test** displays the test being measured. When FED is **Enabled**, the FED icon and numeric state are displayed beside the Current Test. Here you can switch to another test from the given list. However, this action will terminate the ongoing measurement test.

Note: The accuracy of the 2 Terminal Capacitance Measurement is impacted by the use of the FED, and the 3 Terminal (default) method is recommended to be used instead.

- **Selected Pair** allows you to select **All Pairs** or a single wire pair for measurement.
- **Cable Parameters:**
 - **Cable Type** displays the ID, Cable Name and Fill, and allows you to select an entry (with its associated parameters) from the current Cable Book, to use for testing. The selection is not saved when leaving the test. The current Cable Book entry is shown by default.
 - **Capacitance T-R/A-B** displays the capacitance value from Tip to Ring in

nF/mi or km ranging from 10.0 to 500.0.



- **Capacitance T/R or A/B to GND/E** displays the capacitance value from Tip or Ring to Ground, in nF/mi or km ranging from 10.0 to 500.0.

- **Threshold Settings** button opens a new page that allows you to set the capacitance balance threshold for the test.
- **Result** displays a snapshot of the pass/fail status, **Capacitance** and **Length** for each selected wire pair. **Capacitive Balance** is shown in % when **All Pairs** are selected.
- **Test Status** displays the current state of measurement or an error message.

To select the parameter values:

1. Press the up/down arrow keys to highlight the desired parameter.
2. Press the left/right arrow keys to view and select the options.

OR

3. Press  on a value to open a list box of options and use the navigation keys to scroll through.
4. Press  to confirm the value.

Continuous

The **Continuous** function measures each pair, displaying and updating results in *real time*, until you stop the test. The last valid results then remain displayed. Significant fluctuations in the capacitance results/length could indicate intermittent or wet faults, or a partial open.

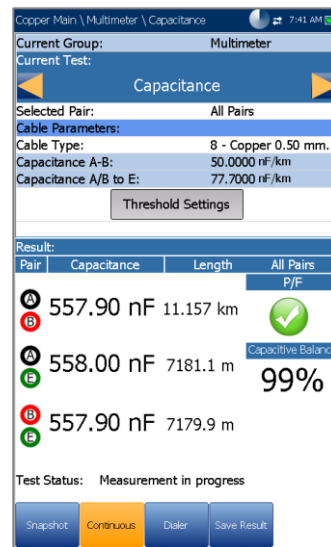



- **Current Group** is the current test group name, for example **Multimeter**.
- **Current Test** displays the test being measured. When FED is **Enabled**, the FED icon and numeric state are displayed beside the **Current Test**. Here you can switch to another test from the given list. However, this action will terminate the ongoing measurement test.

*Note: The accuracy of the **2 Terminal Capacitance Measurement** is impacted by the use of the **FED**, and the **3 Terminal (default) method** is recommended to be used instead.*

- **Selected Pair** allows you to select **All Pairs** or a single wire pair for measurement.
- Cable Parameters:
 - **Cable Type** displays the ID, Cable Name and Fill, and allows you to select an entry (with its associated parameters) from the current Cable Book, to use for testing. The selection is not saved when leaving the test. The current Cable Book entry is shown by default.
 - **Capacitance T-R/A-B** displays the capacitance value from Tip to Ring in nF/mi or km ranging from 10.0 to 500.0.
 - **Capacitance T/R or A/B to GND/E** displays the capacitance value from Tip or Ring to Ground, in nF/mi or km ranging from 10.0 to 500.0.
- **Threshold Settings** button opens a new page that allows you to set the capacitance balance threshold for the test.
- **Result** displays a snapshot of the pass/fail status, **Capacitance** and **Length** for each selected wire pair. **Capacitive Balance** is shown in % when **All Pairs** is selected.
- **Test Status** displays the current state of measurement or an error message.

To select the parameter values:

1. Press the up/down arrow keys to highlight the desired parameter.
2. Press the left/right arrow keys to view and select the options.
OR
3. Press  on a value to open a list box of options and use the navigation keys to scroll through.
4. Press  to confirm the value.

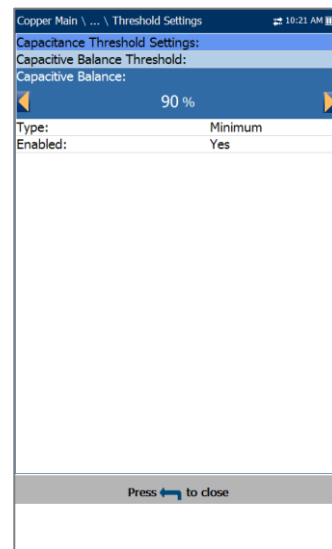

Capacitance/Opens Threshold Settings

The **Threshold Settings** page allows you to set the **Capacitive Balance Threshold** parameters for the test between 0 and 100 %. The threshold is a programmable value you can use as an on-screen indicator in each test when a measured value is too high or too low. POTS and internet circuits should be 95 %, and higher speed broadband circuits 97 % or 98 % if possible.



- **Type** is the threshold limit for each pair: either **Maximum** or **Minimum**.
- **Enabled** is a flag to use the current threshold: either **Yes** or **No**.

To select the threshold values:

1. Press the up/down arrow keys to highlight the desired parameter.
2. Press the left/right arrow keys to view and select the options.
OR
3. Press  on a value to open a list box of options and use the navigation keys to scroll through.
4. Press  to confirm the value.

9.8 Station Ground

The **Station Ground** test measures and displays the resistance value and pass/fail status of the ground resistance between the 6100-Cu and the CO (Central Office). A provisioned POTS circuit is required for this test to work properly.

The test uses Tip (A), Ring (B), and Ground (Earth) leads and measures isolation resistance between the wires and to ground. Any ground should be < 25 Ω for safety reasons, and for high speed broadband (to minimize noise and interference), the ground value should < 5 Ω . If a ground value is > 25 Ω , it may not provide a good path to ground and the current could injure a person. For values between a few ohms and 25, there may be a differential with the premises ground potential, and some noise may couple onto communications circuits.

Depending on where you measure the station ground, check the bonding lugs on cross-boxes, pedestals, and electronics/remotes, as well as cable and terminal bonds. These all need to be good quality and tight. If you think the ground rod/plane is inadequate, please consult your support, management, or procedures.

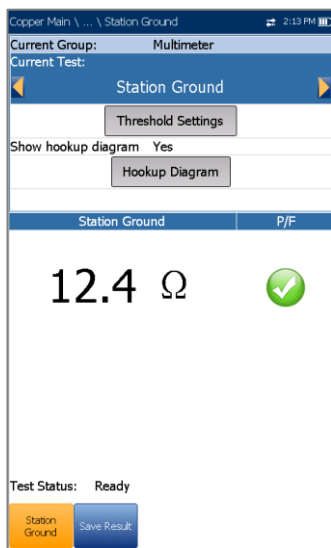

The **Station Ground** parameters are as follows:

- **Current Group** is the current test group name, for example **Multimeter**.
- **Current Test** displays the test being measured. Here you can switch to another **Multimeter** test from the given list. However, this action will terminate the ongoing measurement test.
- **Threshold Settings** button opens a new page that allows you to set the **Ground Resistance Threshold** for the test.
- **Show hookup diagram on test setup** - If **Yes**, the **Confirmation** page is prompted before every **Station Ground** test is started. Select **No** to hide the diagram next time you run the test.

- **Hookup Diagram** button opens a **Confirmation** page displaying how to connect your leads at the beginning of the test.

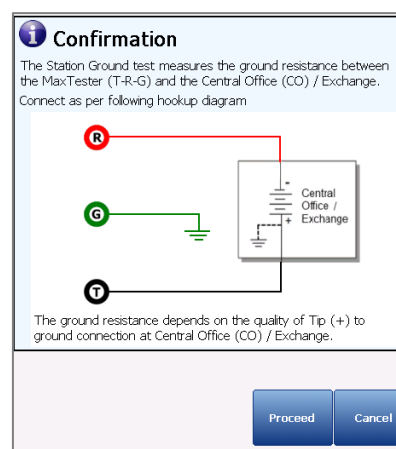

The hookup diagram uses the following graphic and textual components:

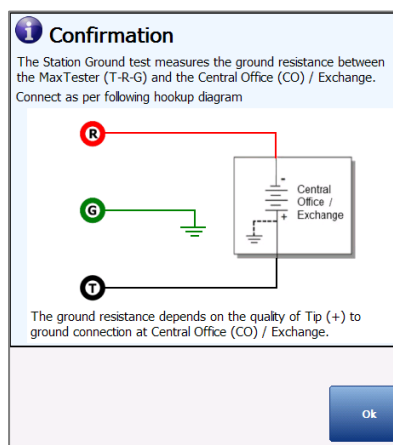

- **Proceed** button closes the hookup diagram prompt and starts the test.
- **Cancel** button closes the hookup diagram prompt only.
- The **Confirmation** window is prompted before every **Station Ground** test is started if you selected **Yes** for the **Show hookup diagram**. You can select **No** to hide the diagram next time you run the test.
- However, you can check the connection diagram at any time by pressing the **Hookup Diagram** button. In this case, the test does not start when you press the **OK** button to close the **Confirmation** window.
- **Test Status** displays the current state of measurement or an error message.



To select the Station Ground parameter values:

1. Press the up/down arrow keys to highlight the desired parameter.
2. Press the left/right arrow keys to view and select the options.

OR

3. Press  on a value to open a list box of options.
4. Press  to confirm the value.

Threshold Settings

The **Test Thresholds** page allows you to set the threshold values for the Ground Resistance. The threshold is a programmable value you can use as an on-screen indicator in each test when a measured value is too high or too low.

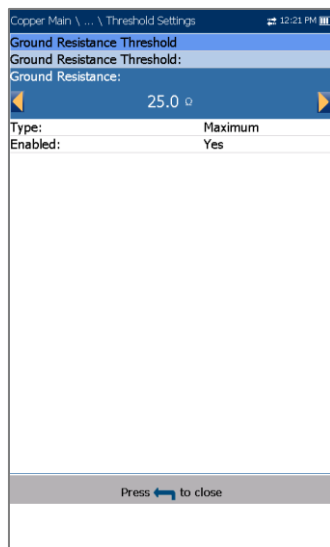



- **Type** is the threshold limit: either **Maximum** or **Minimum**.
- **Enabled** is a flag to use the current threshold: either **Yes** or **No**.

To set threshold values:

1. Press the up/down arrow keys to highlight the desired parameter.
2. Press the left/right arrow keys to view and select the options.

OR

3. Press  on a value to open a list box of options or the alphanumeric editor screen and use the navigation keys to scroll through.
4. Press  to confirm the value.

Result Details

The **Result Details** read-only page displays the **Station Ground** results and the pass/fail status.

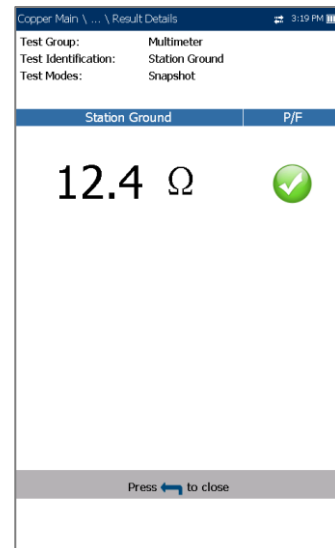

- **Test Group** is the overall test group of the selected saved results file, for example **Multimeter**.
- **Test Identification** is the test type of the group, for example **Station Ground**.
- **Test Modes** identifies the manner in which the test was run, for example **Snapshot**.

9.9 Stressed Balance

Stressed Balance is an optional test that continuously generates high voltage (135 VDC) to the cable pair under test while measuring balance. The high voltage *stresses* the conductors in order to reveal imbalances that may otherwise be hidden with the normal **VF/AC Balance** test.

The test is very similar to the classic *stress* test well known in North America. Compared to the VF (longitudinal) Balance test, values for the **Stressed Balance** test are depicted as follows (but check your own methods and procedures):

- good < 20 dBRNc
- marginal = 20 to 30 dBRNc
- bad > 30 dBRNc

In general, a pair that *stresses* < 25 dBRNc is well balanced for POTS and ADSL internet service. However, higher speed ADSL2+ and VDSL2 circuits should stress < 20. A low stress value (> 20) indicates imbalance on the pair, which can have different causes. Most common causes are grounds and shorts, but also

one-sided series resistance (sometimes also called high-open, high-resistive fault, or *dirty open*). Poor or failing splice connectors/beanies also cause minor imbalances affecting higher speed DSL circuits.

Watch the stress level, and if you see an increase or jump after a minute or two or more, the stress may have worked through some corrosion and thus revealed an imbalance. However, if the stress improves and you see a lower value after a minute or two, then the stress voltage may have dried up some moisture, thus hiding a wet/damp fault which will appear again when more moisture works its way back into the fault.

When you have a poor stress value (> 25), the next best step is to isolate the imbalance by running the **Pair Detective** test.

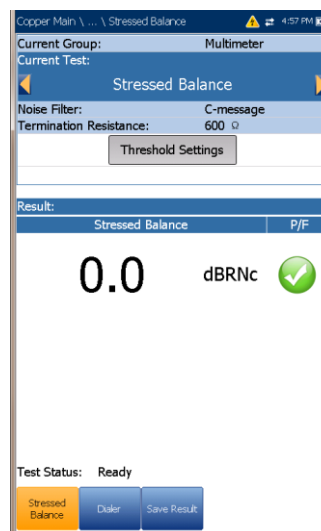

To access Pair Detective from Multimeter tests:

1. Press to return to the **Copper Main** menu.
2. Highlight **Pair Detective** and press to launch the test.
3. Open the far end, and see that faults are identified.
4. Check the **Pair Detective TDR** to locate identified faults.

If corrosion is identified, it may be difficult to locate with the **TDR**. To confirm, run the **Resistive Balance** test.

To access the Resistive Balance test:

1. Press to return to the Multimeter menu.
2. Highlight **Resistive Balance** and press to launch the test.

It does first require a T-R-G/A-B-Earth short at the far end. This will confirm if ohms on one side are higher than the other and there is a one-sided high-resistive fault. If the Ohms on the faulted side measure < 20 M Ohms, use the **RFL Single/Separate Good Pair** method (depending on available spare pairs) to try to locate the corrosion. See [RFL](#) on page 128 for more help on using this test.

The **Stressed Balance** parameters are as follows:

- Current Group is the current test group name, for example Multimeter.
- Current Test displays the test being measured. Here you can switch to another Multimeter test from the given list. However, this action will terminate the ongoing measurement test.
- Noise Filter is a fixed value set to C-message.
- Termination Resistance is a read-only value of 600Ω .
- Threshold Settings button opens a new page that allows you to set the Stressed Balance Threshold for the test.
- Result displays the measurement value for Stressed Balance and pass/fail status dependent on the Good/Marginal Balance threshold settings.
- Test Status displays the current state of measurement or an error message.

To select the Stressed Balance parameter values:

1. Press the up/down arrow keys to highlight the desired parameter.
2. Press the left/right arrow keys to view and select the options.

OR

3. Press on a value to open a list box of options.
4. Press to confirm the value.

Threshold Settings

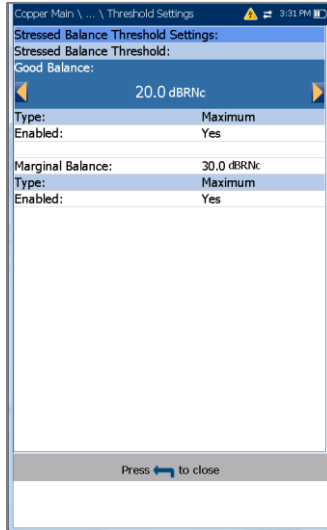

The **Threshold Settings** page allows you to set the **Good/Marginal Balance** threshold values for the **Stressed Balance** test. The threshold is a programmable value you can use as an on-screen indicator in each test when a measured value is too high or too low.



- **Type** is the threshold limit and is fixed to **Maximum**.
- **Enabled** is a flag to use the current threshold: either **Yes** or **No**.

*Note: Disabling **Good Balance** will also disable the **Marginal Balance** threshold, even if you **Enabled** it.*

To set threshold values:

1. Press the up/down arrow keys to highlight the desired parameter.
 2. Press the left/right arrow keys to view and select the options.
- OR
3. Press  on a value to open a list box of options or the alphanumeric editor screen and use the navigation keys to scroll through.
 4. Press  to confirm the value.

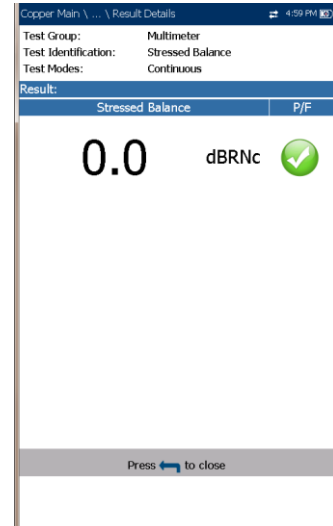

- **Test Group** is the overall test group of the selected saved results file, for example **Multimeter**.
- **Test Identification** is the test type of the group, for example **Stressed Balance**.
- **Test Modes** identifies the manner in which the test was run, for example **Continuous**.

Result Details

The **Result Details** read-only page displays the **Stressed Balance** results and the pass/fail status. Good values are lower (≤ 20) compared to the VF (longitudinal) Balance test (≥ 60).

Section 10 SmartR Features

SmartR features, consisting of **Pair Detective** and **FaultMapper**, are a line of intelligent tests that go beyond plain results to also identify and locate faults automatically. They allow you to quickly determine the condition of the line under test with color-coded, plain language results, as well as identify and locate a variety of common circuit faults on a simple, graphical result screen.

10.1 Pair Detective

The **Pair Detective** test is a quick, one-minute pair quality assessment and sequence of tests that does more than just give numbers. It correlates results using plain language and color codes to identify common metallic faults and imbalances such as shorts and grounds.

Pair Detective includes high voltage isolation/leakage tests and **Auto TDR** to quickly locate identified faults. It also includes two unique tests, corrosion and wet detect, found nowhere else in the test set. In one minute, you have a great picture of pair quality and it is easy to stop the test, move to a new pair, and run the test again when looking for spare pairs.

Before proceeding with this test, ensure the line is inactive and open at far end.

At the start of any test, the unit checks for the presence of dangerous voltage and an active circuit. If dangerous voltage is detected, a dialog box is displayed to inform you and the test will stop. If an active circuit is detected, a dialog box is displayed to ask you whether or not to proceed with the test.

Summary

The **Summary** page displays a summary of the pass/fail status, **DC-Voltage/Current** and **Isolation** for each selected inactive wire pair, as well as other detailed results of the Pair Detective test. Plain language results are displayed as the test progresses, with color coding to draw attention to faults. You may view raw results by selecting the **Multimeter** tab at the bottom of the screen.

TDR is also automatically started in auto-mode, to locate the nearest significant event/reflection; it remains on and ready for your usage upon test completion (select the **TDR** tab to use).

Pair Detective runs two unique tests found nowhere else in the 6100-Cu: **Corrosion** and **Wet** detect.

Corrosion detect identifies the presence of one-sided corrosion or series resistance (such as a high resistive or partial, dirty open), while **Wet** detect tells you if a fault (faulted splice joint or module, for example) is damp. (Pair Detective cannot identify flooded cable sections; use **TDR** for this problem.)

Pair Detective can find or indicate the following faults/conditions:

- **Device Detection** results for the following providers, set up in the **Application Settings\Standard\NTD Provider**. Possible results include **No Device Detected**, **Short**, **Disabled**, and **Unknown Device**. Results specific to each parameter include:
 - **None**
 - Phone On/Off Hook
 - **France**
 - FT ITD
 - FT ITD and Phone On/Off Hook
 - Phone On/Off Hook
 - **Germany**
 - DT SD
 - DT PPA
 - DT PPA inverted
 - DT PA and SD
 - DT PPA inverted and SD
 - Phone Off Hook
 - **Italy**
 - TI User Jack with Capacitor (C)
 - TI User Jack with C and Phone On/Off Hook
 - Phone On/Off Hook
 - **Slovakia**
 - DT PPA
 - DT PPA inverted
 - DT PPA and Phone On Hook
 - DT PPA inverted and Phone On Hook
 - Phone On/Off Hook
- Battery
- Shorts/hard short
- Grounds/high resistive ground
- Opens/possible high resistive open
- Imbalanced pair
- Corrosion (one sided series resistance)

- Wet detected (but not flooded section)

Isolation results also display a five-level indicator of the measured isolation/leakage resistance.

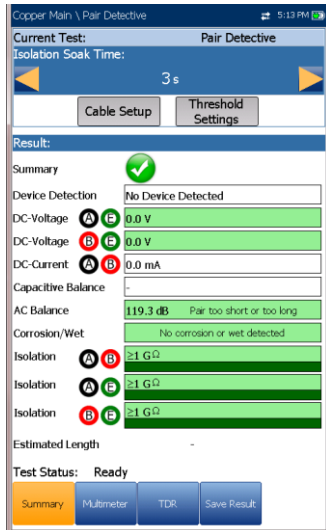

The **Summary** page allows you to set the following parameters:

- **Isolation Soak Time** sets a soak period of time from 1 to 60 seconds for the **Isolation** test. Default is 5 s. If your unit has the HIVOLT (high voltage) software option configured, the Soak Voltage parameter values are extended up to 500 V maximum. Default is inherited from **Multimeter Isolation** test.

Note: The application of higher voltage over time tends to dry-up moisture. Some faults may appear to disappear after a soak period, but only the moisture has disappeared. The fault remains and moisture will likely return at a later time. Therefore, do not extend the soak time unless testing insulation resistivity (PIC, paper, etc.).

- **Cable Setup** button opens a new page that allows you to set the **Cable Parameters** for the test.
- **Threshold Settings** button opens a new page that allows you to set the threshold parameters. They control when **Pair Detectives** identifies a fault, such as 4 VDC for a battery fault. You can also modify when **Pair Detectives** identifies a high-resistive versus normal fault by changing the threshold parameters.

Note: Individual test parameters can be modified by accessing their respective test pages.

To select the parameter values:

1. Press the up/down arrow keys to highlight the desired parameter.

2. Press the left/right arrow keys to view and select the options.

OR

3. Press on a value to open the alphanumeric editor screen and use the navigation keys to scroll through.
4. Press to confirm the value.

Pair Detectives Cable Setup

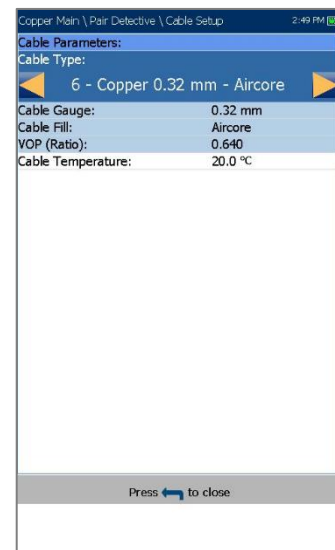

The **Cable Setup** page allows you to set **Cable Parameters** for the **Pair Detectives** test.



- **Cable Type** displays the ID, Cable Name and Fill, and allows you to select an entry (with its associated parameters) from the current Cable Book, to use for testing. The selection is not saved when leaving the test. The current Cable Book entry is shown by default. These cable parameters affect distance calculations of **Capacitance/Opens** and **Resistance** measurements, and the **TDR** cursor distance indication.
- **Cable Gauge** identifies the gauge system for measuring wire sizes in AWG (American Wire Gauge) units or mm (metric wire size).
- **Cable Fill** read-only entry is the type of material the cable is filled with: **Aircore**, **Jelly**, **Pulp**, **5 PR**, or **2 PR**. Setup in the **Cable Book**. This value affects **Capacitance/Opens** distance calculations.
- **Velocity of Propagation** read-only entry is the velocity of propagation for the cable. Setup in the **Cable Book**. This value changes the distance shown at the cursor.
- **Cable Temperature** allows you to change the temperature of the cable under test in either °F

or °C. Temperature primarily affects **Resistance** measurements.

To select the parameter values:

1. Press the up/down arrow keys to highlight the desired parameter.
2. Press the left/right arrow keys to view and select the options.
OR
3. Press  on a value to open a list box of options or the alphanumeric editor screen and use the navigation keys to scroll through.
4. Press  to confirm the value.

Pair Detective Threshold Settings

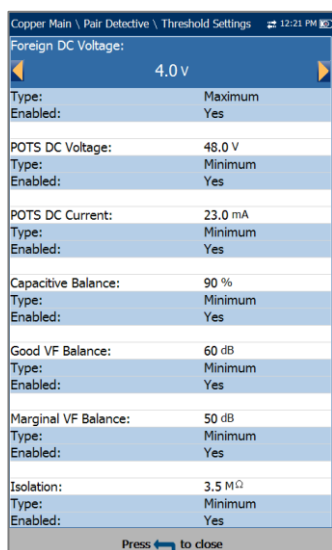

The **Threshold Settings** page allows you to set the threshold parameters for the tests below. Modifying these values will change what color is used on a result and when a fault is identified, such as a short at 3.5 M Ohms.



- **Foreign DC Voltage** sets the maximum foreign DC voltage value. Default is 4 V which is fine for POTS and internet circuits; consider a lower value for a high-speed DSL such as VDSL2.
- **POTS DC Voltage** sets the minimum working POTS DC voltage value.
- **POTS DC Current** sets the minimum working POTS DC current value.
- **Capacitive Balance** sets the minimum capacitive balance threshold as a percentage.
- **Good VF/AC Balance** sets the good VF/AC balance threshold.

- **Marginal VF/AC Balance** sets the marginal VF/AC balance threshold.
- **Isolation** sets the isolation resistance threshold.
- **Type** is a read-only field displaying the threshold limit: either **Minimum** or **Maximum**.
- **Enabled** is a read-only field and always **Yes** for all thresholds.

To set threshold values:

1. Press the up/down arrow keys to highlight the desired parameter.
2. Press  on a value to open the alphanumeric editor screen and use the navigation keys to scroll through.
3. Press  to select each value and use the function keys to complete your selection.
4. Press  to confirm and close your selections.

Multimeter

Copper Main \ Pair Detective			
DC Voltage			
Pair	VDC	P/F	
T-R	4.9	✓	
T-G	3.6	✓	
R-G	2.2	✓	
DC Current			
Pair	DC		
T-R	8.5 mA		
Capacitance			
Pair	Capacitance	Length	All Pairs P/F
T-R	880 pF	55 ft	✗
T-G	1.7 nF	70 ft	Capacitive Balance
R-G	160 pF	6 ft	9 %
Isolation			
Pair	Resistance	Soak Counter (s)	P/F
T-R	23.9 Ω	5	✗
T-G	24.8 Ω	5	✗
R-G	25.2 Ω	5	✗

The **Multimeter** page displays the raw values used by **Pair Detective** to identify a fault on the summary screen. Read-only results and the **P/F** (pass/fail) status are shown for the following tests:

- **DC Voltage** displays the volts for each DC **Pair**.
- **DC Current** displays the **DC** current results for T-R/A-B wire **Pair**.
- **Capacitance/Opens** displays Capacitance and Length for each wire **Pair** as well as Capacitive Balance among All Pairs in %.
- **Isolation** displays **Resistance** and a **Soak Counter** for each wire **Pair**.

TDR

TDR is included to help locate faults identified on the summary screen, and runs every time **Pair Detective** runs. It remains running and allows you to control and edit the **TDR** test. It runs continuously after the one-minute test cycle is completed using the setup parameters from the initial cycle of the **Pair Detective** test. After saving the results, the **Pair Detective** results will contain the **Estimated Length** value as found for the initial cycle of the **Pair Detective** test. But you may continue to use the **TDR** test to further locate faults on the line.

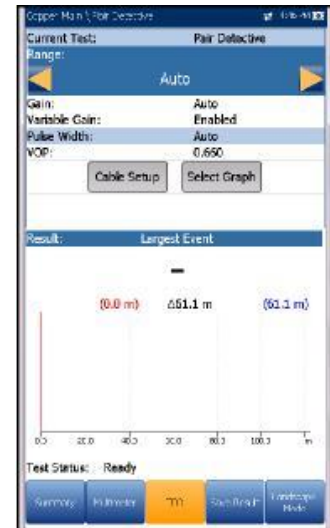

The **TDR** test displays the line trace and is continuously on and ready to use. It displays and updates results in real time, in either **Portrait** or **Landscape Mode** (recommended), until you stop the test. The last valid results then remain displayed.

- **Current Test** displays the test being measured.
- **Range** allows you to set the range from the given list.
- **Gain** allows you select the gain test parameter from the given list.
- The previous 2 parameters have 2 modes of operation:
 - **Auto** is the default mode upon loading the test page. **TDR** automatically optimizes the test parameters and scans each band individually looking for one **Largest Event** in each band (if any). **Range** and **Gain** are updated to reflect optimized TDR settings. Once results are displayed, TDR switches to manual mode. The test keeps running until you press Start/Stop.
 - **Manual** mode allows you set the test parameters to be used as inputs for the TDR measurements.

Note: If either of the above 2 test parameters are set to Auto, respective parameter values will be updated by TDR test.



- **Pulse Width** is a non-editable value that is updated dependent on whether the parameters are set to **Auto** or manual. The test set automatically adjusts pulse width based on the range selected. (A manual control **TDR** is available in the **TDR** sub-menu from the **Copper Main** menu).

- **VOP** allows you to change the velocity of propagation value for the cable.
- **Cable Setup** button opens a new page that allows you to set the **Cable Parameters** for the **Current Test**.

*Note: For more options and control, exit the **Pair Detective** test and select **TDR** from the **Copper Main** menu.*

- **Select Graph** button changes to **Graph Selected** when pressed and opens a new selection of function keys which allow you to maneuver the graph as follows:
 - **Cursor/Marker** allows you to select the cursor (blue) or marker (red) independently by toggling the function key. The footer updates to reflect either **Move cursor** or **Move marker**. Press the left/right arrow keys to decrease/increase the values by moving the cursor/marker. Press and hold the left/right arrow keys to accelerate the cursor/marker. Press  to recall the cursor/marker and place it in the middle of the current x-axis limits.
 - **Zoom** references the middle of the x/y axis and not the cursor position. Press the arrow keys as follows:
Right = x-axis zoom in.
Left = x-axis zoom out.
Up = y-axis zoom in.
Down = y-axis zoom out.
 - **Pan** - use left/right arrow keys to pan the x-axis and the up/down arrow keys to pan the y-axis.
 - **1:1** resets the x-axis and y-axis limits to full scale.
 - **Return To Test** removes these function keys and displays the **Continuous** page.
- **Result** displays the distance to the most significant reflection, in text and graphical measurements. The distance Δ (Delta) value between cursor and marker is also displayed at the top of the graph.
- **Test Status** displays the current state of measurement or an error message.

To select the parameter values in Portrait Mode:

1. Press the up/down arrow keys to highlight the desired parameter.
2. Press the left/right arrow keys to view, select the options, or increase/decrease values.
OR
3. Press  on a value to open a list box of options or the alphanumeric editor screen and use the navigation keys to scroll through.
4. Press  to confirm the value.

- **Landscape Mode** is the best way to use the TDR and allows you to view the test results in landscape mode utilizing the full length of the high resolution, color screen. Whether the keyboard is on the right or left is dependent on your preferred **Landscape Mode Settings** configured in **Setup/Application Settings/General**.
- **Landscape Mode** generates the following function keys:
 - **Portrait Mode** is used to change the screen orientation from landscape to portrait.
 - **Select Graph** opens a new selection of function keys which allow you to maneuver the graph. (Same as above.)
 - **Parameters** displays a small strip window listing the following values: **Range** and **Gain**, and **Pulse Width**. They can be edited or viewed as described in **Portrait Mode** (above).
 - **Cable Setup** displays a small strip window when selected allowing you to change the **Cable Type** and **Cable Temperature**. You can also view the **Cable Gauge** and **Cable Fill** entries which were setup in **Cable Book**, and **Velocity of Propagation**. For more information, see [Pair Detective Cable Setup](#) on page 72.

To select the parameter values in Landscape Mode:

1. Press the desired function key.
2. For **Parameters** and **Cable Setup**, press the up/down arrow keys to highlight the desired parameter.
3. Press the left/right arrow keys to view, select the options, or increase/decrease values.
4. Press  to confirm the value.

TDR Cable Setup

The **Cable Setup** page is the same as previously described. Please see [Pair Detective Cable Setup](#) on page 72 for more information.

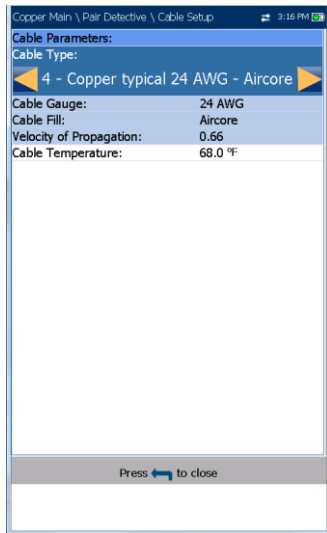

- **Cable Fill** is the type of material the cable is filled with: **Aircore, Jelly, Pulp, 5 PR,** or **2 PR.**
- **Velocity of Propagation** is the velocity of propagation for the cable.
- **Cable Temperature** is the temperature of the cable under test in either °F or °C.
- **Result** displays a **Summary** of the overall pass/fail status, **DC-Voltage/Current** and **Isolation** for each selected wire pair, as well as other detailed results of the **Pair Detective** test.
 - **Isolation** results also display a five-level indicator of the measured resistance, when it is below the **Hard Short** resistance threshold (on the **Thresholds Settings** page).
 - **Estimated Length** displays the length of the circuit as found from the **TDR** test for the first cycle of the **Pair Detective** test.

10.2 Pair Detective Result Details

Summary

The read-only **Summary** page displays the cable parameters and detailed results saved from running the **Pair Detective** test.

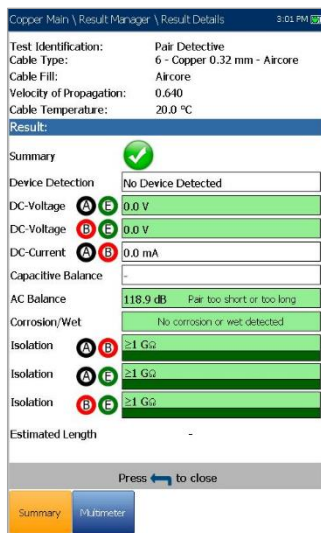

- **Test Identification** is the test type of the group, for example **Pair Detective.**
- **Cable Type** displays the ID, Cable Name and Fill, (with its associated parameters) from the current Cable Book, used for testing.

Multimeter

The read-only **Multimeter** page displays detailed results saved from running the **Pair Detective** test. Please refer to [Multimeter](#) on page 74 for more information.

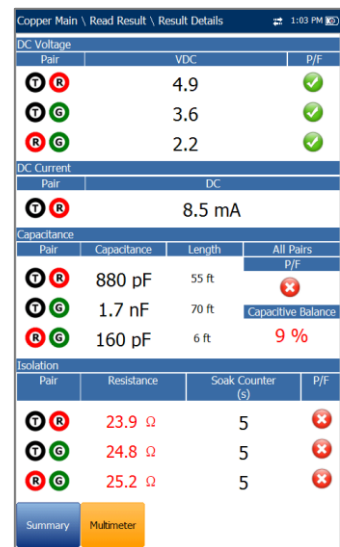

10.3 FaultMapper

The **FaultMapper** is a graphical snapshot of the pair to locate and identify line faults. It combines and analyzes the results of several different tests including capacitance, resistance, TDR, and RFL, to draw a diagram of the pair depicting common faults.

FaultMapper does not find all faults but rather many common faults, and can identify more than one at a time. This test is useful in locating bridged taps, shorts, grounds, and opens but only one bridged tap at a time. (To look for more bridged taps, clear the first bridged tap and run the test again). The **TDR** function key is available for your reference, although FaultMapper is not solely a TDR and performs some signal analysis.

FaultMapper can identify and/or locate the following:

- Shorts
- Grounds (strap required to determine distance)
- Opens
- Detect load coils
- Bridged tap

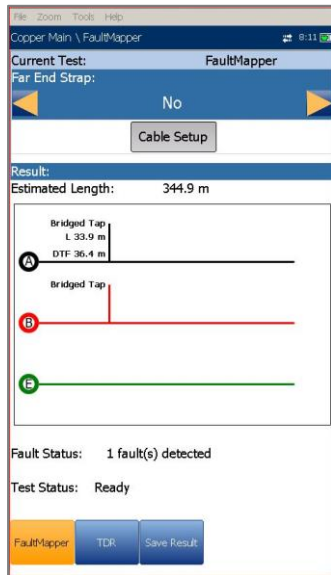

The **FaultMapper** page displays the following parameters:

- **Current Test** displays the test being measured.
- **Far End Strap** allows you to select option **Yes** or **No** for use of a strap.

A strap, while not required, enables **FaultMapper** to calculate distance to a ground/earth fault. The test will use some RFL routines here, and you do not have to exit to run RFL. (RFL is located on the **Copper Main** menu.)

- **Cable Setup** button opens a new page that allows you to set the **Cable Parameters** for the **Current Test**.
- **Result** displays the cable faults in text and graphical format.

Note: When running FaultMapper with a strap at the far end of the pair, and there is a T-G/A-E fault, the strap may also cause FaultMapper to display a R-G/B-E short. In such cases, the resistance shown is the resistance that would be measured using a multimeter.

- **Estimated Length** displays the cable length when the cable is open.

Note: The cable length may include the Bridge Tap length: remove the Bridge Tap for better accuracy.

- **Fault Status** displays the number of faults detected (or **No fault detected**) after running the test. The status **Open** detected is reported in the following case:

- No strap.
- The pair is open.
- No faults (other than the pair being open).

- Open and the distance to Open is displayed and represented using X in the graph.

- Test Status displays the current state of measurement or an error message.

•

To select the parameter values:

1. Press the up/down arrow keys to highlight the desired parameter.
2. Press the left/right arrow keys to view and select the options.

OR

3. Press ✓ on a value to open a list box of options.
4. Press ✓ to confirm the value.

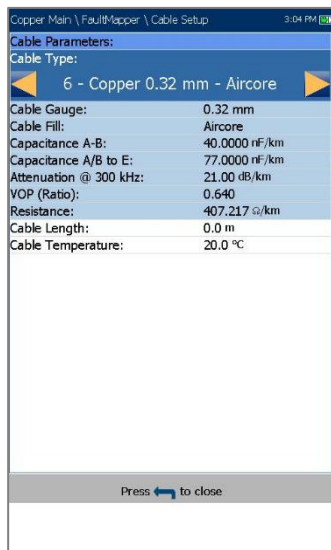

Cable Setup

The **Cable Setup** page allows you to set the **Cable Type**, **Cable Length**, and **Cable Temperature** for the FaultMapper test. All other **Cable Parameters** are read only and correspond to the current cable book entry as selected in **Setup/Cable Book/Cable Details** page. These cable parameters affect distance calculations of **Capacitance/Opens** and **Resistance** measurements, and the **TDR** cursor distance indication.



- **Cable Type** displays the ID, Cable Name and Fill, and allows you to select an entry (with its associated parameters) from the current Cable Book, to use for testing. The selection is not saved when leaving the test. The current Cable Book entry is shown by default.
- **Cable Gauge** identifies the gauge system for measuring wire sizes, in AWG (American Wire Gauge) units or mm (metric wire size).
- **Cable Fill** read-only entry is the type of material the cable is filled with: **Aircore**, **Jelly**, **Pulp**, **5 PR**, or **2 PR**.
- **Capacitance T-R/A-B** read-only entry is a value for the capacitance per length constant used to calculate distance to opens.
- **Capacitance T/R to GND/A/B to E** read-only entry is a value for the capacitance per length to ground constant.
- **Attenuation @ 300 kHz** read-only entry is a value in dB for the reduction in signal strength or insertion loss of the cable at a frequency of 300 kHz. (This frequency has been widely used as a loss measurement for ADSL, but not validated for ADSL2+ nor VDSL2.)
- **Velocity of Propagation** read-only entry is the velocity of propagation for the cable. This value is used to convert the timed TDR pulses into a distance for the cursor position.
- **Resistance** read-only entry is a value for the resistance constant of the cable.
- **Cable Length** allows you to set the length of the cable for more accurate results.
- **Cable Temperature** allows you to change the temperature of the cable under test in either °F or °C.

To select the parameter values:

1. Press the up/down arrow keys to highlight the desired parameter.
2. Press the left/right arrow keys to view and select the options.
OR
3. Press  on a value to open a list box of options or the alphanumeric editor screen and use the navigation keys to scroll through.
4. Press  to confirm the value.

TDR

The FaultMapper **TDR** function provides a shortcut to the TDR test. A dialogue box opens, warning that you are about to leave the **FaultMapper** test. TDR results captured while running FaultMapper will be available upon loading TDR. Please go to [TDR](#) on page 117 for information on this test.

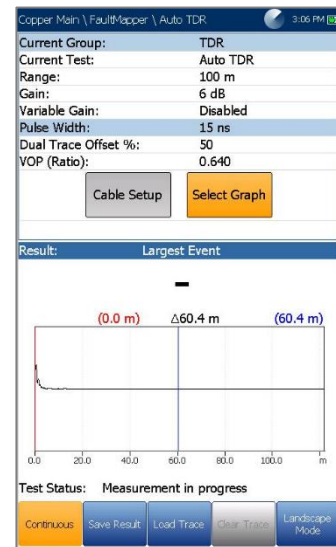

FaultMapper Result Details

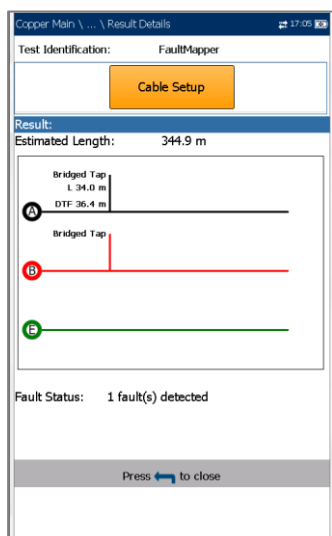

The **Result Details** read-only page displays the test results in text and graphical format.

- **Test Identification** is the name of the test, for example **FaultMapper**.
- **Cable Setup** button opens a new page displaying the cable parameters of the test. Use the left/right arrows to select the button and press to open the page.
- **Result** displays the cable fault details.

Note: When running FaultMapper with a strap at the far end of the pair, and there is a T-G/A-E fault, the strap may also cause FaultMapper to display a R-G/B-E short. In such cases, the resistance shown is the resistance that would be measured using a multimeter.

- **Estimated Length** displays the cable length when the cable is open.
- **Fault Status** displays the number of faults detected (or **No fault detected**) after running the test.

Result Details Cable Setup

The **Cable Setup** page in the **Result Details** allows you to view the **Cable Parameters** set for the **FaultMapper** test.

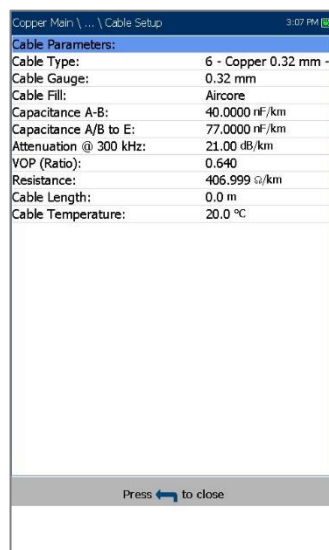

- **Cable Type** displays the ID, Cable Name and Fill, (with its associated parameters) from the current Cable Book, used for testing.
- **Cable Gauge** identifies the gauge system for measuring wire sizes, in AWG (American Wire Gauge) units or mm (metric wire size).
- **Cable Fill** is the type of material the cable is filled with: **Aircore**, **Jelly**, **Pulp**, **5 PR**, or **2 PR**.
- **Capacitance T-R/A-B** is the value for the capacitance per length constant.
- **Capacitance T/R to GND/A/B to E** is the value for the capacitance per length to ground constant.
- **Attenuation @ 300 kHz** is the value for the reduction in signal strength or insertion loss of the cable.
- **Velocity of Propagation** is the velocity of propagation for the cable.
- **Resistance** is the value for the resistance constant of the cable.
- **Cable Length** is the length of the cable set to provide more accurate results.
- **Cable Temperature** is the temperature of the cable under test in either °F or °C.

FaultMapper Profile Details

The **Profile Details** page displays read-only FaultMapper **Test Parameters**.

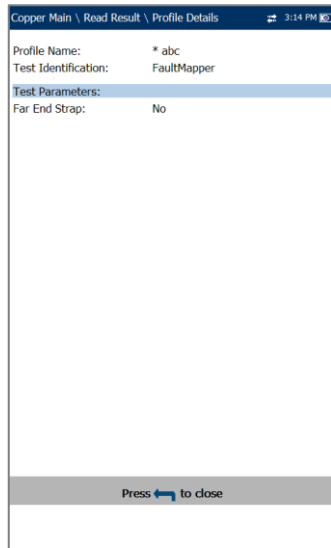

- **Profile Name** is the file name of the selected saved results.
- **Test Identification** is the test type of the group, for example **FaultMapper**.

Section 11 Noise Tests

The purpose of the noise tests is to perform VF/WB (voice frequency / wideband) noise and level measurements.

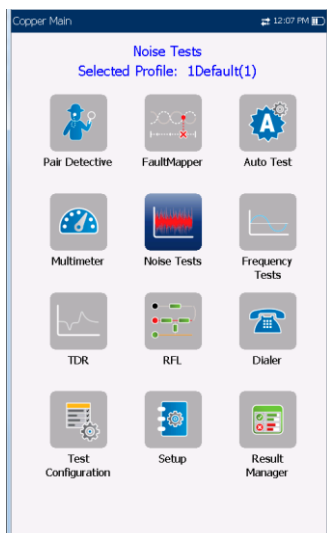

Note: The 30 MHz Wideband Testing software option is required for the WB tests to be available.

To access noise tests:

From the **Copper Main** pane, highlight **Noise Tests** and press  to open the menu.

11.1 Noise Tests Main Page

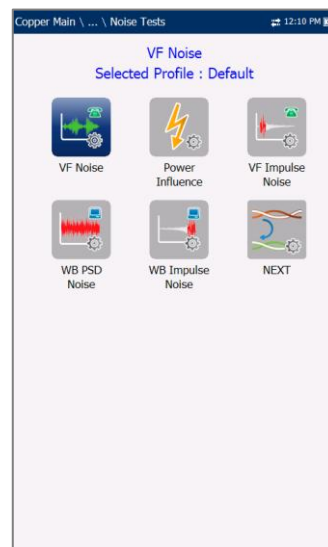

The **Noise Tests** menu allows you to select and run the displayed tests:

- **VF Noise**
- **Power Influence**
- **VF Impulse Noise**
- **WB PSD Noise**
- **WB Impulse Noise**
- **NEXT**

To start/stop a test:

1. Press the up/down left/right arrow keys on the keypad to select the desired test icon.
2. Press  to confirm your selection.
3. The test will start automatically if the **Setup/Application Settings - Test Startup Mode** is set to Auto. If not, press Start/Stop on the keypad.

11.2 VF Noise

The **VF Noise** test allows you to measure the amount of unwanted or disturbing energy introduced into a loop from man-made and natural sources.

Detection

The **Detection** function displays and updates results in real time, until you stop the test. The last valid results then remain displayed.

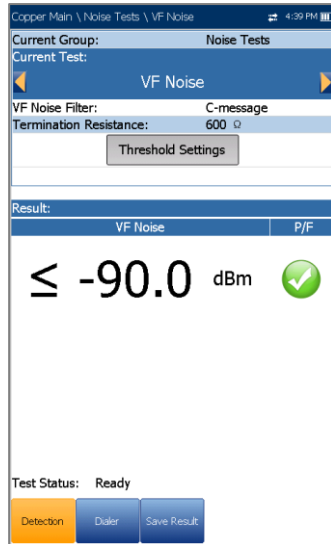

- **Current Group** is the current test group name, for example **Noise**.
- **Current Test** displays the test being measured. Here you can switch to another test from the given list. However, this action will terminate the ongoing measurement test.
- **VF Noise Filter** allows you to define the voice frequency noise filter to be used, dependent on **ITU or ANSI Standard** mode and the **Noise Filter** set in **Setup/Application Settings**.
- **Termination Resistance** is a read-only value of 600 Ω.
- **Threshold Settings** button opens a new page that allows you to set the **VF Noise** threshold.
- **Result** displays the pass/fail status and **VF Noise** value.
- **Test Status** displays the current state of measurement or an error message.

Note: The selected VF Noise Filter shown in addition to the current Level units selected in Setup/Application Settings have an influence on the measurement units displayed on this page.

To select the parameter values:

1. Press the up/down arrow keys to highlight the desired parameter.
2. Press the left/right arrow keys to view and select the options.
OR
3. Press on a value to open a list box of options.
4. Press to confirm the value.

VF Noise Threshold Settings

The **Threshold Settings** page allows you to set the **VF Noise Threshold** values for the test.

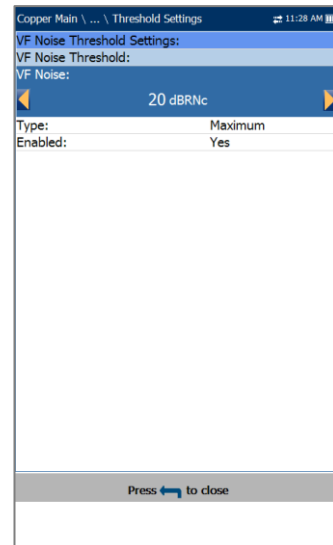

- **Type** is the threshold limit: either **Maximum** or **Minimum**.
- **Enabled** is a flag to use the current threshold: either **Yes** or **No**.

To set threshold values:

1. Press the up/down arrow keys to highlight the desired parameter.
2. Press the left/right arrow keys to view and select the options.
OR
3. Press on a value to open a list box of options or the alphanumeric editor screen and use the navigation keys to scroll through.
4. Press to confirm the value.

Result Details

The **Results Details** read-only page displays the **VF Noise** value and the pass/fail status.



11.3 Power Influence

The Power Influence test allows you to view the effects of interference from a 50 Hz or 60 Hz power source (AC mains) on the circuit under test. The results of the power influence test are also in graphical form.

Detection

The **Detection** function displays and updates results in *real time*, until you stop the test. The last valid results then remain displayed.

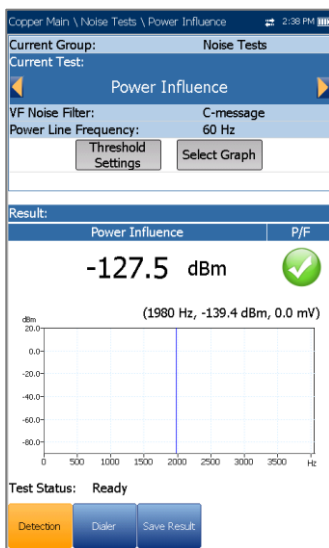



- **Current Group** is the current test group name, for example **Noise**.
- **Current Test** displays the test being measured. Here you can switch to another test from the given list. However, this action will terminate the ongoing measurement test.
- **VF Noise Filter** allows you to define the voice frequency noise filter to be used, dependent on ITU or ANSI Standard mode and the **Noise Filter** set in **Setup/Application Settings**.
- **Power Line Frequency** is a read-only value of 50 or 60 Hz based on frequency selected in **Setup/Application Settings/Standard**.
- **Threshold Settings** button opens a new page that allows you to set the power influence thresholds.
- **Select Graph** button changes to **Graph Selected** when pressed and opens a new selection of function keys which allow you to maneuver the graph as follows:
 - **Cursor** - press the left/right arrow keys to decrease/increase the values by moving the cursor. Press and hold the left/right arrow keys to accelerate the cursor. Press ✓ to recall the cursor and place it in the middle of the current x-axis limits.
 - **Zoom** references the middle of the x/y axis and not the cursor position. Press the arrow keys as follows:
 - Right = x-axis zoom in.
 - Left = x-axis zoom out.
 - Up = y-axis zoom in.
 - Down = y-axis zoom out.
 - **Pan** - use left/right arrow keys to pan the x-axis and the up/down arrow keys to pan the y-axis.
 - **1:1** resets the x-axis and y-axis limits to full scale.
 - **Return To Test** removes these function keys and displays the **Detection** page.
- **Result** displays a value and graph of the **Power Influence** measurement, and pass/fail status.
- **Test Status** displays the current state of measurement or an error message.

To select the parameter values:

1. Press the up/down arrow keys to highlight the desired parameter.
2. Press the left/right arrow keys to view and select the options.

OR

3. Press  on a value to open a list box of options.
4. Press  to confirm the value.

Power Influence Threshold Settings

The **Threshold Settings** page allows you to set the **Threshold Power Influence** values for the test.

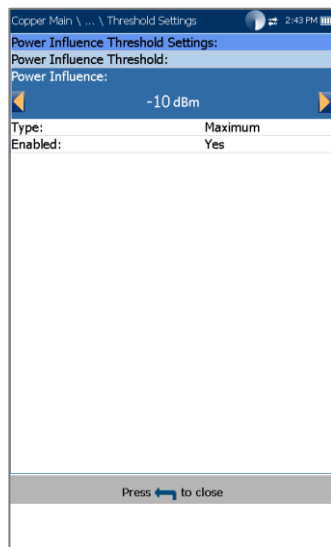



- **Type** is the threshold limit: either **Maximum** or **Minimum**.
- **Enabled** is a flag to use the current threshold: either **Yes** or **No**.

To set threshold values:

1. Press the up/down arrow keys to highlight the desired parameter.
2. Press the left/right arrow keys to view and select the options.

OR

3. Press  on a value to open a list box of options or the alphanumeric editor screen and use the navigation keys to scroll through.
4. Press  to confirm the value.

Result Details

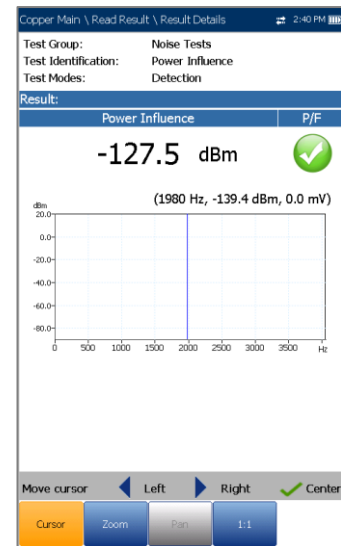

The **Result Details** page displays the **Power Influence** value and graph, and the pass/fail status. You can maneuver the graph as follows:

- **Cursor** - press the left/right arrow keys to decrease/increase the values by moving the cursor. Press and hold the left/right arrow keys to accelerate the cursor. Press  to recall the cursor and place it in the middle of the current x-axis limits.
 - **Zoom** references the middle of the x/y axis and not the cursor position. Press the arrow keys as follows:
 - Right = x-axis zoom in.
 - Left = x-axis zoom out.
 - Up = y-axis zoom in.
 - Down = y-axis zoom out.
 - **Pan** - use left/right arrow keys to pan the x-axis and the up/down arrow keys to pan the y-axis.
 - **1:1** resets the x-axis and y-axis limits to full scale.

11.4 VF Impulse Noise

The **VF Impulse Noise** test allows you to measure voice frequency impulse noise on the circuit under test.

Count

The **Count** function displays and updates results in *real time*, for the length of time set in **Test Duration** or less

if you stop the test. The last valid results then remain displayed.

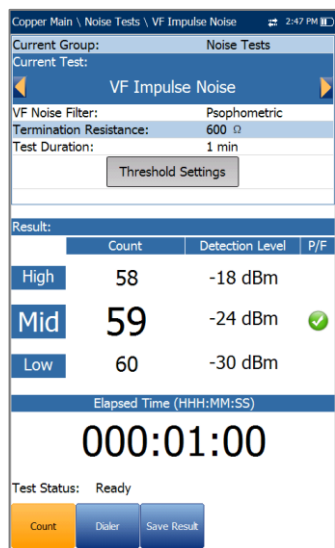

- **Current Group** is the current test group name, for example **Noise Tests**.
- **Current Test** displays the test being measured. Here you can switch to another test from the given list. However, this action will terminate the ongoing measurement test.
- **VF Noise Filter** allows you to define the voice frequency noise filter to be used, dependent on **ITU** or **ANSI Standard** mode and the **Noise Filter** set in **Setup/Application Settings**.
- Termination Resistance is a read-only value of 600 Ω.
- **Test Duration** allows you to set the length of time to run the test from a list of values. If **UFED Control** option is enabled, the maximum value is limited to 15 min.
- **Threshold Settings** button opens a new page that allows you to set the VF impulse noise thresholds.
- **Result** displays the **High**, **Mid**, **Low** counts, respective detection levels, and **Elapsed Time**. The pass/fail status of the **Mid** level is displayed after 1 s and then periodically refreshed, until you stop the test.
- **Test Status** displays the current state of measurement or an error message.

To select the parameter values:

1. Press the up/down arrow keys to highlight the desired parameter.
2. Press the left/right arrow keys to view and select the options.
OR
3. Press on a value to open a list box of options.
4. Press to confirm the value.

VF Impulse Noise Threshold Settings

The **Threshold Settings** page allows you to set the **VF Impulse Noise Threshold** values for the test.

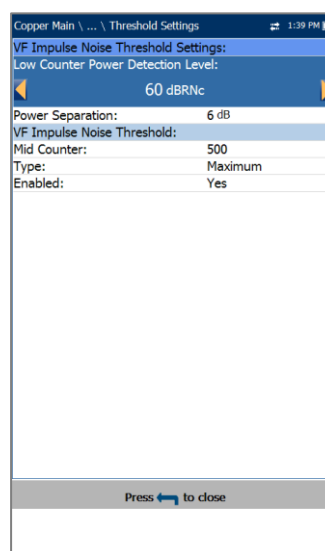



- **Low Counter Power Detection** Level defines the low threshold limits for the impulse noise test.
- **Power Separation** defines the level difference between the **Low**, **Mid**, and **High** thresholds. Specify a value between 1 and 6 dB.
- **Mid Counter** allows you to set the threshold value for this counter.
- **Type** is the threshold limit of the **Mid Counter**: either **Maximum** or **Minimum**.
- **Enabled** is a flag to use the current **Mid Counter** threshold: either **Yes** or **No**.

To set threshold values:

1. Press the up/down arrow keys to highlight the desired parameter.
2. Press the left/right arrow keys to view and select the options.

OR

- Press  on a value to open a list box of options or the alphanumeric editor screen and use the navigation keys to scroll through.
- Press  to confirm the value.

Result Details

The **Results Details** read-only page displays the **High**, **Mid**, **Low VF Impulse Noise Count** and **Detection Level** values, and the pass/fail status of the **Mid** level.

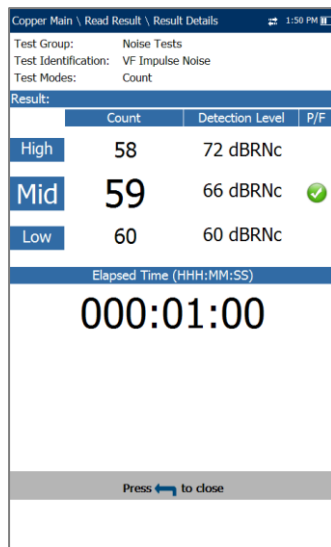

Result:	Count	Detection Level	P/F
High	58	72 dBRNc	
Mid	59	66 dBRNc	
Low	60	60 dBRNc	

Elapsed Time (HHH:MM:SS)
000:01:00

Press  to close

11.5 WB PSD Noise

The wideband power spectral density (PSD) noise test measures the noise energy at a point in a noise spectrum. It is expressed as power per hertz at a point in a noise spectrum.

PSD

The **PSD** page allows you to configure the parameters for the wideband PSD noise test and view the results in either **Portrait** or **Landscape** Mode.

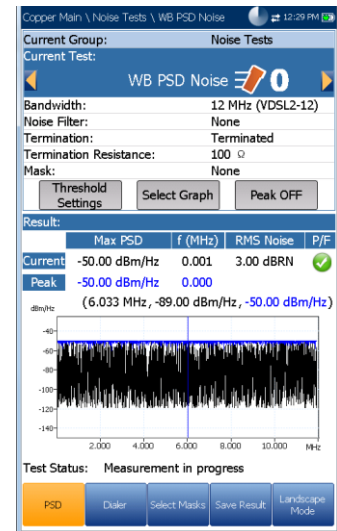

- **Current Group** is the current test group name, for example **Noise Tests**.
- **Current Test** displays the test being measured. Here you can switch to another test from the given list. However, this action will terminate the ongoing measurement test.
- **Bandwidth** allows you to select the frequency range for the test from a list of available bandwidths: **ISDN**, **HDSL**, **SHDSL**, **ADSL1/2**, **ADSL2+**, **VDSL2-8**, **VDSL2-12**, **VDSL2-17**, **VDSL2-30**, or **VDSL2-35**.
- Noise Filter defines the filter currently enabled. Options are: None, ISDN-E, HDSL-F, ADSL-G, ADSL, ADSL2+, VDSL, VDSL2-8, VDSL2-12, VDSL2-17, VDSL2-30, VDSL2-35.
- **Termination** is one of the following:
 - **Terminated** if the termination resistance is internal to the unit.
 - **Bridging** if additional termination resistance is used to bridge onto live circuits with minimal interruption.
 - **HiZ Cable** when using this cable to connect to T1/A1-R1/B1 (Yellow – Blue) connectors. When selected, the **Termination Resistance** automatically sets to **100 Ω**.
- **Termination Resistance** allows you to select the resistance of the dummy load connected to the line, unless HiZ Cable is selected above.
- **Mask** allows you to select a network representing the power signal of other services, overlaid on the active noise graph, to identify its presence on the line under test. All of the masks you enabled from the **Select Masks** tab are listed here for test selection.

- **Threshold Settings** button opens a new page that allows you to set the **RMS Noise Threshold** parameters for the test.
 - **Select Graph** button changes to **Graph Selected** when pressed and opens a new selection of function keys which allow you to maneuver the graph as follows:
 - **Cursor** - press the left/right arrow keys to decrease/increase the values by moving the cursor. Press and hold the left/right arrow keys to accelerate the cursor. Press ✓ to recall the cursor and place it in the middle of the current x-axis limits.
 - **Zoom** references the middle of the x/y axis and not the cursor position. Press the arrow keys as follows:
 - Right = x-axis zoom in.
 - Left = x-axis zoom out.
 - Up = y-axis zoom in.
 - Down = y-axis zoom out.
 - **Pan** - use left/right arrow keys to pan the x-axis and the up/down arrow keys to pan the y-axis.
 - **1:1** resets the x-axis and y-axis limits to full scale.
 - **Return To Test** removes these function keys and displays the previous ones.
 - **Peak ON/OFF** allows you to measure the current PSD noise value, compare it against the peak value at each given frequency, and display the maximum value. Select either **Peak ON** or **Peak OFF**.
 - **Result** displays the following wideband PSD noise test results differentiating the **Current** trace from the **Peak** hold.
 - Max PSD reading among all frequency bins for the Current results.
 - Frequency bin where Max PSD for the Current results are detected.
 - RMS Noise reading for the Current results including a pass/fail status.
- If **Peak Hold** is **ON**:
- **Max PSD Peak** reading among all frequency bins.
 - Frequency bin for **Max PSD Peak**.
- **Test Status** displays the current state of measurement or an error message.

To select the parameter values in Portrait Mode:

1. Press the up/down arrow keys to highlight the desired parameter.
2. Press the left/right arrow keys to view and select the options.

OR

3. Press ✓ on a value to open a list box of options.
4. Press ✓ to confirm the value.

- **Landscape Mode** function key allows you to view the test results in landscape mode. Whether the keyboard is on the right or left is dependent on your preferred **Landscape Mode Settings** configured in **Setup/Application Settings/General**.

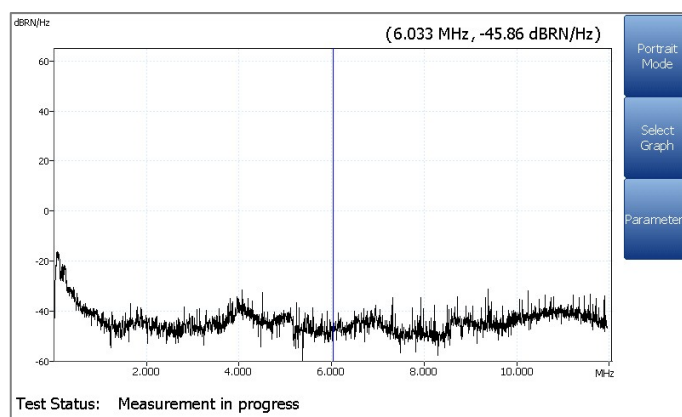

This mode generates the following function keys:

- **Portrait Mode** is used to change the screen orientation from landscape to portrait.
- **Select Graph** opens a new selection of function keys which allow you to maneuver the graph. (Same as above.)
- **Parameters** displays a small strip window when selected allowing you to change the **Bandwidth, Noise Filter, Termination, and Termination Resistance** values from a list of options.

To select the parameter values in Landscape Mode:

1. Press the **Parameters** function key.
2. Press the up/down arrow keys to highlight the desired parameter.
3. Press the left/right arrow keys to view and select the options.
4. Press ✓ to confirm the value.

WB PSD Noise Threshold Settings



The **Threshold Settings** page allows you to set the **RMS Noise Threshold** parameters for the test.



- **Type** is the threshold limit for each pair: either **Maximum** or **Minimum**.
- **Enabled** is a flag to use the current threshold: either **Yes** or **No**.

To set threshold values:

1. Press the up/down arrow keys to highlight the desired parameter.
2. Press the left/right arrow keys to view and select the options.

OR
3. Press  on a value to open a list box of options or the alphanumeric editor screen and use the navigation keys to scroll through.
4. Press  to confirm the value.

Select Masks

The **Select Masks** tab allows you to set parameters and choose which Masks to enable for the PSD test.

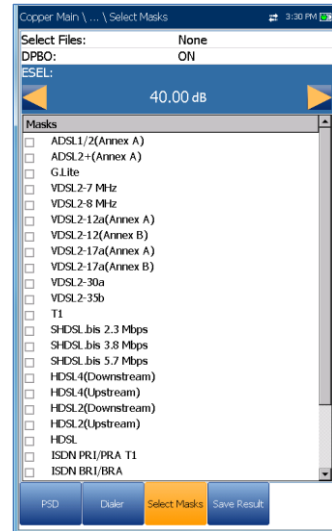





- **Select Files** is either **None** which removes all check marks allowing you to select one or more **Masks**, or **All**.
- **DPBO** (Downstream Power Back Off) is either **ON** or **OFF**.
- **ESEL** (Exchange Side Electrical Length) is used to enter or modify the numerical values of attenuation of the cable at 1 MHz frequency from 0 to 120 dB with one decimal point. This represents the DPBOESEL variable or electrical length of exchange to cabinet cable, and is applied to the DPBO mask calculation.

Note: DPBO and ESEL are only available if Termination is set to Bridging or Hi-Z Cable.

- **Masks** lists all the networks available to select dependent on the **ITU** or **ANSI Standard** mode set in **Setup/Application Settings/Standard**.

To set parameters and enable the Masks for the PSD test:

1. Press the up/down arrow keys to highlight the desired parameter.
2. Press the left/right arrow keys to view and select the options.

OR
3. Press  on a value to open a list box of options or the alphanumeric editor screen and use the navigation keys to scroll through.
4. Press  to confirm the value.
5. If **None** is selected for the files, press the down arrow key to highlight the list box of **Masks** and press  to open the list.
6. In the list, press the up/down arrows to highlight the desired files and press  to select/deselect a **Mask**.

7. Press  to come out of the list.

All of your enabled masks are now listed on the PSD tab page in the Mask parameter, for test selection.

dependent on your preferred **Landscape Mode Settings** configured in **Setup/Application Settings/General**.

- **Portrait Mode** is used to change the screen orientation from landscape to portrait.

Result Details

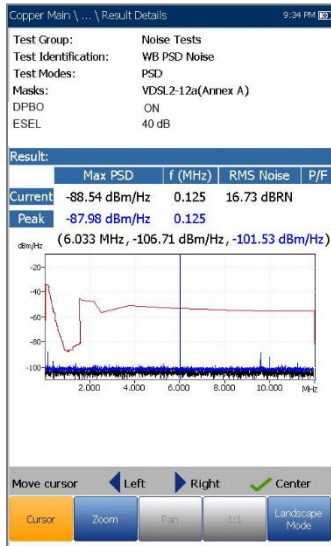

The **Results Details** read-only page displays the WB PSD Noise test results, in text and graphical format. If an ESEL (Exchange Side Electrical Length) value was set, it is also displayed. The graph can be viewed in portrait and landscape modes, and maneuvered as follows:

- **Cursor** - press the left/right arrow keys to decrease/increase the values by moving the cursor. Press and hold the left/right arrow keys to accelerate the cursor. Press  to recall the cursor and place it in the middle of the current x-axis limits.
- **Zoom** references the middle of the x/y axis and not the cursor position. Press the arrow keys as follows:
 - Right = x-axis zoom in.
 - Left = x-axis zoom out.
 - Up = y-axis zoom in.
 - Down = y-axis zoom out.
- **Pan** - use left/right arrow keys to pan the x-axis and the up/down arrow keys to pan the y-axis.
- **1:1** resets the x-axis and y-axis limits to full scale.
- **Landscape Mode** function key allows you to view the test results in landscape mode. Whether the keyboard is on the right or left is

11.6 WB Impulse Noise

The wideband impulse noise test allows you to measure impulse noise on the circuit under test.

Count

The **Count** function displays and updates results in *real time*, for the length of time set in **Test Duration** or less if you stop the test. The last valid results then remain displayed.

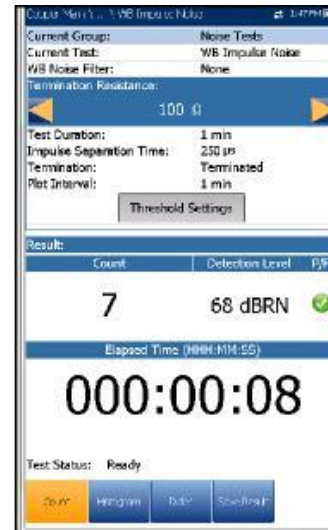

- **Current Group** is the current test group name, for example **Noise Tests**.
- **Current Test** displays the test being measured. Here you can switch to another test from the given list. However, this action will terminate the ongoing measurement test.
- **WB Noise Filter** displays the filter currently enabled. Options are: None, ISDN-E, HDSL-F, ADSL-G, ADSL, ADSL2+, VDSL, VDSL2-8, VDSL2-12, VDSL2-17, VDSL2-30.
- **Termination** is either **Terminated**, if the termination resistance is internal to the unit, or **Bridging** if additional termination resistance is used to *bridge* onto live circuits with minimal interruption.
- **Termination Resistance** lists the resistance of the dummy load connected to the line.

- **Test Duration** allows you to set the length of time to run the test from a list of values. If UFED Control option is enabled, the maximum value is limited to 15 min.
- **Impulse Separation Time (IST)** specifies the time interval between successive impulses. Some impulse events comprise many sub-pulses or a pulse-train. Use a larger IST to capture longer events of many sub-pulses, or a smaller IST between events to capture fast sub-pulses as separate impulse events.
- **Threshold Settings** button opens a new page that allows you to set the **Power Detection Level** and **WB Impulse Noise** thresholds.
- **Result** displays the **Count**, **Detection Level**, **Elapsed Time**, and pass/fail status which is periodically refreshed, until you stop the test.
- **Test Status** displays the current state of measurement or an error message.

To select the parameter values:

1. Press the up/down arrow keys to highlight the desired parameter.
2. Press the left/right arrow keys to view and select the options.
OR
3. Press ✓ on a value to open a list box of options or the alphanumeric editor screen and use the navigation keys to scroll through.
4. Press ✓ to confirm the value.

WB Impulse Noise Threshold Settings

The **Threshold Settings** page allows you to set the **WB Impulse Noise Threshold** values for the test.

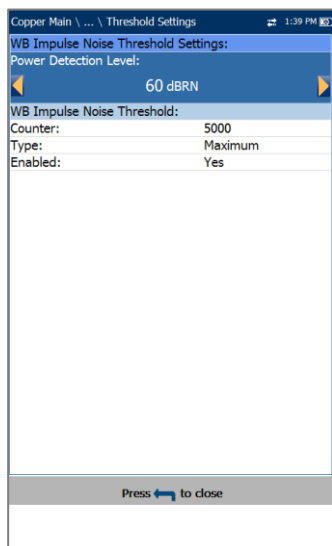

- **Power Detection Level** defines the threshold limits.
- **Counter** allows you to set the threshold value for this counter.
- **Type** is the threshold limit for each pair: either **Maximum** or **Minimum**.
- **Enabled** is a flag to use the current threshold: either **Yes** or **No**.

To set threshold values:

1. Press the up/down arrow keys to highlight the desired parameter.
2. Press the left/right arrow keys to view and select the options.
OR
3. Press ✓ on a value to open a list box of options or the alphanumeric editor screen and use the navigation keys to scroll through.
4. Press ✓ to confirm the value.

Histogram

The **Histogram** tab records the Elapsed Time, the Total Counts of impulse durations that are collected during each plot interval, and pass/fail status. The bar graph displays the impulse counts vs time.

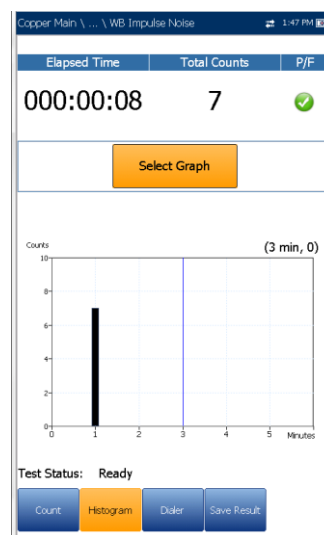

Select Graph button changes to **Graph Selected** when pressed and opens a new selection of function keys which allow you to maneuver the graph as follows:

- **Cursor** - press the left/right arrow keys to decrease/increase the values by moving the cursor. Press and hold the left/right arrow keys to accelerate the cursor. Press ✓ to recall the

cursor and place it in the middle of the current x-axis limits.

- **Zoom** references the middle of the x/y axis and not the cursor position. Press the arrow keys as follows:
 - Right = x-axis zoom in.
 - Left = x-axis zoom out.
 - Up = y-axis zoom in.
 - Down = y-axis zoom out.
- **Pan** - use left/right arrow keys to pan the x-axis and the up/down arrow keys to pan the y-axis.
- **1:1** resets the x-axis and y-axis limits to full scale.
- **Return To Test** removes these function keys and displays the previous ones.

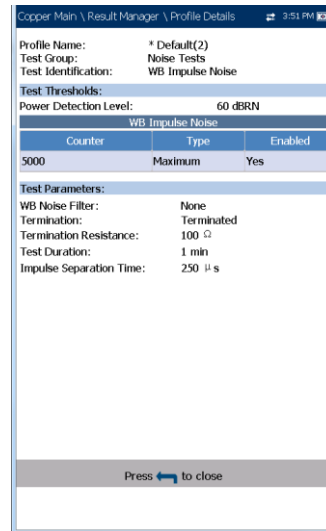

Result Details Count

The **Results Details** read-only page displays the **WB Impulse Noise Count, Detection Level**, and pass/fail status.

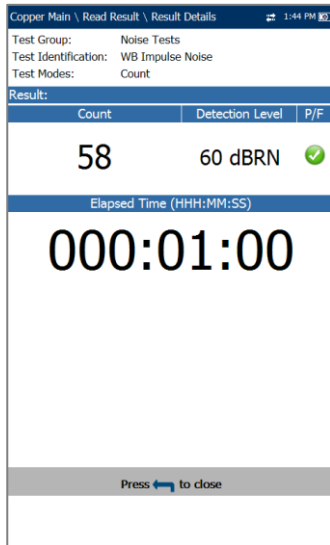

Profile Details

The **WB Impulse Noise Profile Details** read-only page displays the test thresholds and parameters along with the **Impulse Separation Time** value.

11.7 NEXT

The **NEXT** test measures the Near End Crosstalk (NEXT) between 2 pairs of cables. The test transmits a signal on the T/A - R/B pair, and measures the received crosstalk on T1/A1 - R1/B1 pair.

Spot

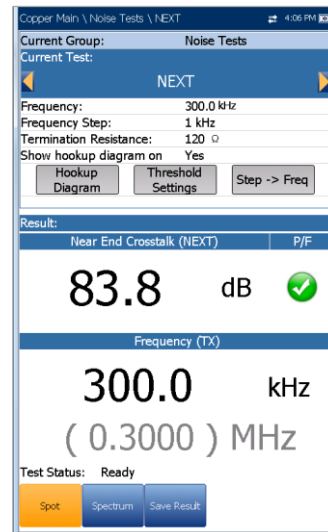

Spot is a continuous mode of operation measuring the crosstalk for a specific frequency selected by you, similar to the method used by the **Send Tone** test. The **Spot** function displays and updates results in real time, until you stop the test. The last valid results then remain displayed.

- **Current Group** is the current test group name, for example Noise Tests.
- **Current Test** displays the test being measured. Here you can switch to another Noise test from the given list. However, this

action will terminate the ongoing measurement test.

- **Frequency** allows you to set the frequency value for the **Near End Crosstalk (NEXT)**.
- **Frequency Step** lists a choice of frequency step values.
- **Termination Resistance** lists a choice of resistance values for the termination of the signal.
- **Show hookup diagram** on test setup - If **Yes**, the Confirmation page is prompted before every NEXT test is started. Select **No** to hide the diagram next time you run the test.
- **Hookup Diagram** button opens a **Confirmation** page displaying how to connect your cables at the beginning of the test. When FED is **Enabled** on the FED Setup page, both the T-R/A-B and T1-R1/A1-B1 pairs will be terminated at the FED. The hookup diagram uses graphic and textual components.
 - **Proceed** button closes the hookup diagram prompt and starts the test.
 - **Cancel** button closes the hookup diagram prompt only.

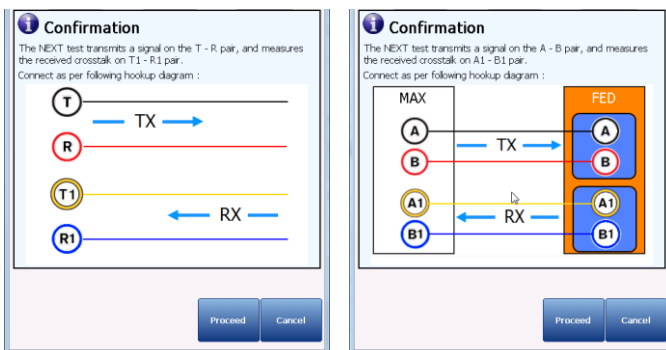

- The **Confirmation** window is prompted before every **NEXT** test is started if you selected **Yes** for the **Show hookup diagram**. You can select **No** to hide the diagram next time you run the test.

However, you can check the connection diagram at any time by pressing the **Hookup Diagram** button. In this case, the test does not start when you press the **OK** button to close the **Confirmation** window.

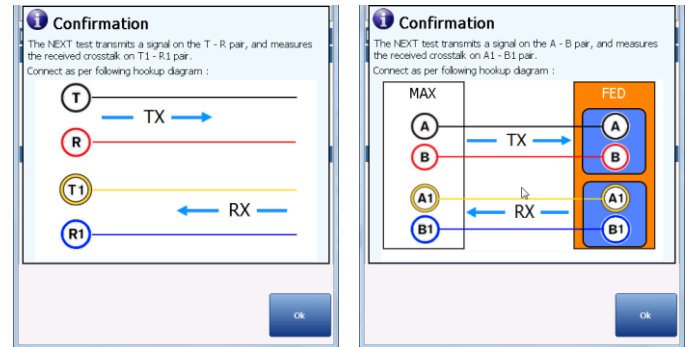

- **Threshold Settings** button opens a new page that allows you to set the NEXT Spot Threshold for the test.
- **Step -> Freq** button automatically enters/transfers the **Frequency Step** value into the **Frequency** value. If the step size is less than 10 kHz (but not 4.3125 kHz), the **Frequency** value will be set to 10 kHz. If the **Frequency Step** is set to 4.3125 kHz, the **Frequency** value will be set to 8.6250 kHz.
- **Result** displays the pass/fail status, **NEXT** and **Frequency (TX)** values.
- **Test Status** displays the current state of measurement or an error message.

To select the Spot parameter values:

1. Press the up/down arrow keys to highlight the desired parameter.
2. Press the left/right arrow keys to view and select the options.
OR
3. Press **✓** on a value to open a list box of options or the alphanumeric editor screen and use the navigation keys to scroll through.
4. Press **✓** to confirm the value.

Spot Threshold Settings

The **Threshold Settings** page allows you to set the threshold values for the **NEXT Spot** test.

- **Type** is the threshold limit: either **Maximum** or **Minimum**.
- **Enabled** is a flag to use the current threshold: either **Yes** or **No**.

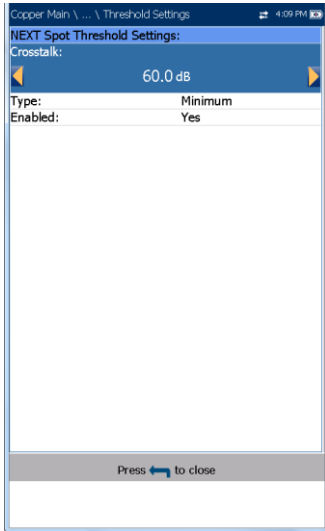

To set threshold values:

1. Press the up/down arrow keys to highlight the desired parameter.
 2. Press the left/right arrow keys to view and select the options.
- OR
3. Press ✓ on a value to open a list box of options or the alphanumeric editor screen and use the navigation keys to scroll through.
 4. Press ✓ to confirm the value.

Spot Result Details

The **Spot Results Details** read-only page displays the saved pass/fail status, **NEXT** and **Frequency (TX)** values.

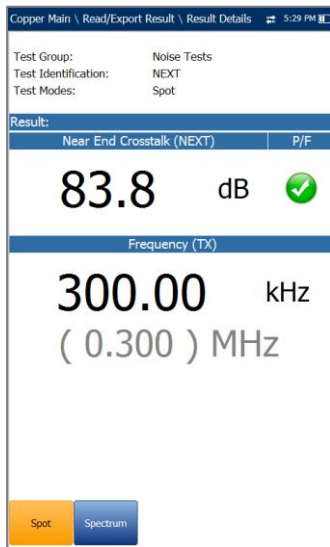

Spectrum

Spectrum is a snapshot mode of operation similar to **WB Attenuation**. The test makes one measurement of the crosstalk for the selected bandwidth, and then stops.

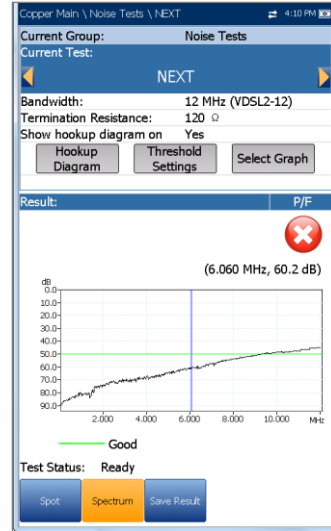

- **Current Group** is the current test group name, for example **Noise Tests**.
- **Current Test** displays the test being measured. Here you can switch to another Noise test from the given list. However, this action will terminate the ongoing measurement test.
- **Bandwidth** allows you to select the bandwidth of the frequency range for the test. Available frequency bandwidths are: **2.2 MHz, 8 MHz, 12 MHz, 17.6 MHz and 30 MHz**.
- **Termination Resistance** lists a choice of resistance values for the termination of the signal.
- **Show hookup diagram** on test setup - If **Yes**, the Confirmation page is prompted before every NEXT test is started. Select **No** to hide the diagram next time you run the test.
- **Hookup Diagram** button opens a **Confirmation** page displaying how to connect your cables at the beginning of the test. When FED is **Enabled** on the **FED Setup** page, both the T-R/A-B and T1-R1/A1-B1 pairs will be terminated at the FED. The hookup diagram uses graphic and textual components.
 - **Proceed** button closes the hookup diagram prompt and starts the test.

- **Cancel** button closes the hookup diagram prompt only.

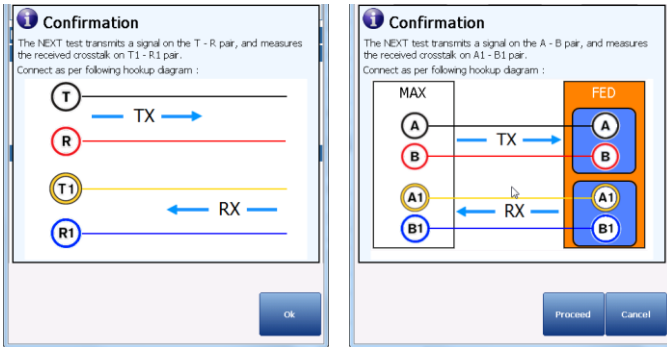

- The **Confirmation** window is prompted before every **NEXT** test is started if you selected **Yes** for the **Show hookup diagram**. You can select **No** to hide the diagram next time you run the test.

However, you can check the connection diagram at any time by pressing the **Hookup Diagram** button. In this case, the test does not start when you press the **OK** button to close the **Confirmation** window.

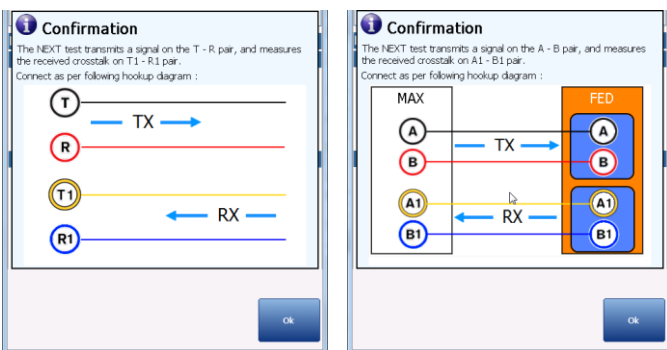

- **Threshold Settings** button opens a new page that allows you to set the **NEXT Spectrum Threshold**.
- **Select Graph** button changes to **Graph Selected** when pressed and opens a new selection of function keys which allow you to maneuver the graph as follows:
 - **Cursor** - press the left/right arrow keys to decrease/increase the values by moving the cursor. Press and hold the left/right arrow keys to accelerate the cursor. Press ✓ to recall the cursor and place it in the middle of the current x-axis limits.
 - **Zoom** references the middle of the x/y axis and not the cursor position. Press the arrow keys as follows:

Right = x-axis zoom in.

Left = x-axis zoom out.

Up = y-axis zoom in.

Down = y-axis zoom out.

- **Pan** - use left/right arrow keys to pan the x-axis and the up/down arrow keys to pan the y-axis.
- **1:1** resets the x-axis and y-axis limits to full scale.
- **Return To Test** removes these function keys and displays the Spectrum page.
- **Result** displays the pass/fail status, and test results in graphical format.
- **Good** is the good threshold value for the selected bandwidth, represented by a horizontal green line.
- **Test Status** displays the current state of measurement or an error message.

To select the parameter values:

1. Press the up/down arrow keys to highlight the desired parameter.
 2. Press the left/right arrow keys to view and select the options.
- OR
3. Press ✓ on a value to open a list box of options.
 4. Press ✓ to confirm the value.



Spectrum Threshold Settings

The **Threshold Settings** page allows you to set the **Crosstalk** threshold values at fixed and periodic frequencies.

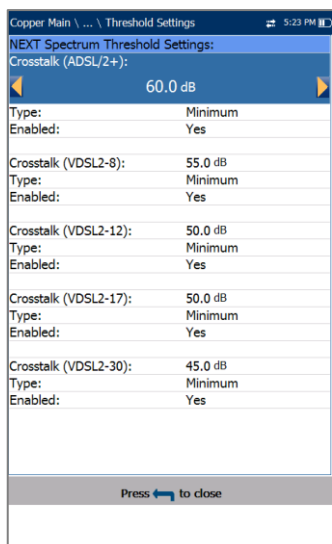
- **Type** is the threshold limit: either **Maximum** or **Minimum**.
- **Enabled** is a flag to use the existing threshold: either **Yes** or **No**. For example, setting the threshold **Enabled** to **No** will disable pass/fail threshold.





To set threshold values:

1. Press the up/down arrow keys to highlight the desired parameter.
2. Press the left/right arrow keys to view and select the options.
OR
3. Press  on a value to open a list box of options or the alphanumeric editor screen and use the navigation keys to scroll through.
4. Press  to confirm the value.

Spectrum Result Details

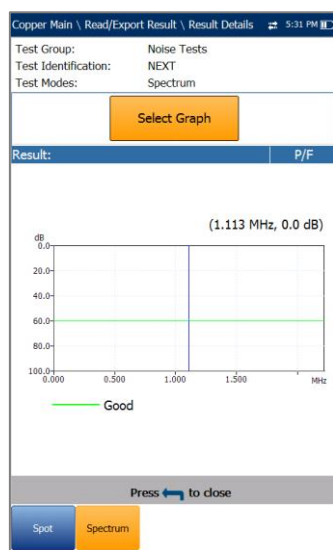
The **Spectrum Results Details** read-only page displays the pass/fail status and test results in graphical format.



- **Test Group** is the overall test group of the selected saved results file, for example **Noise Tests**.
- **Test Identification** is the test type of the group, for example **NEXT**.
- **Test Modes** is the mode of test, for example **Spectrum**.
- **Select Graph** button opens a new selection of function keys which allow you to maneuver the graph as follows:
 - **Cursor** - press the left/right arrow keys to decrease/increase the values by moving the cursor. Press and hold the left/right arrow keys to accelerate the cursor. Press  to recall the cursor and place it in the middle of the current x-axis limits.
 - **Zoom** references the middle of the x/y axis and not the cursor position. Press the arrow keys as follows:
Right = x-axis zoom in.
Left = x-axis zoom out.
Up = y-axis zoom in.
Down = y-axis zoom out.
 - **Pan** - use left/right arrow keys to pan the x-axis and the up/down arrow keys to pan the y-axis.
 - **1:1** resets the x-axis and y-axis limits to full scale.
 - **Return To Test** removes these function keys and returns to the **Spectrum** results page.

NEXT Results Profile Details

The **NEXT Profile Details** page displays detailed read-only test thresholds and parameters for both Spot and Spectrum modes.

The screenshot shows the 'Profile Details' screen for a 'NEXT' profile. It is divided into three main sections: Profile Information, Test Thresholds, and Test Parameters.

Profile Information:

- Profile Name: Default
- Test Group: Noise Tests
- Test Identification: NEXT

Test Thresholds:

Spot Mode:

Threshold	Type	Enabled
60.0 dB	Minimum	Yes

Spectrum Mode:

Parameter	Value	Type	Enabled
Crosstalk (ADSL/2+)	60.0 dB	Minimum	Yes
Crosstalk (VDSL2-8)	55.0 dB	Minimum	Yes
Crosstalk (VDSL2-12)	50.0 dB	Minimum	Yes
Crosstalk (VDSL2-17)	50.0 dB	Minimum	Yes
Crosstalk (VDSL2-30)	45.0 dB	Minimum	Yes

Test Parameters:

Spot Mode:

- Frequency: 300.0 kHz
- Frequency Step: 1 kHz
- Termination Impedance: 100 Ω

Spectrum Mode:

- Bandwidth: 2.2 MHz (ADSL2+)
- Termination Impedance: 100 Ω

At the bottom of the screen, there is a button that says 'Press [Back Arrow] to close'.

- **Profile Name** is the file name of the selected saved results.
- **Test Group** is the overall test group of the selected saved results file, for example **Noise Tests**.
- **Test Identification** is the test type of the group, for example **NEXT**.

Section 12 Frequency Tests

The purpose of the frequency tests is to perform VF (voice frequency) and WB (wide band) level measurements, calculate the reduction of signal strength during transmission, measure the balance of a circuit, and count and detect the presence of load coils.

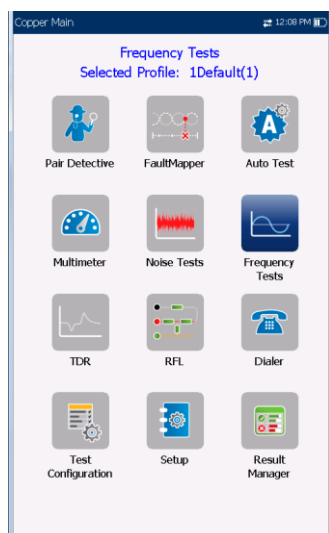

To access frequency tests:

From the **Copper Main** pane, highlight **Frequency Tests** and press **✓** to open the menu.

12.1 Frequency Tests Main Page



The **Frequency Tests** menu allows you to select and run the displayed tests:

- **VF/AC Balance**
- **WB Balance**
- **WB Attenuation**
- **Return Loss**
- **Load Coils**
- **Locator Tone**
- **TX/RX Tone**
- **RX Tone with FED**

To start/stop a test:

1. Press the up/down left/right arrow keys on the keypad to select the desired test icon.
2. Press **✓** to confirm your selection.
3. The test will start automatically if the **Setup/Application Settings/General - Test Startup Mode** is set to **Auto**. If not, press Start/Stop on the keypad.

12.2 VF/AC Balance

The VF/AC Balance test allows you to check that the VF longitudinal balance ratio for the twisted pair complies with applicable standards so as to reduce the effects of common-mode voltage to ground.

The test is a measurement of how much the T/A leg is like the R/B leg in electrical characteristics, measured by how much noise the line can mitigate (in dB). It is an overall health indicator and a quick way to tell if the line is in good condition. The better the longitudinal balance of the cable pair, the higher the dB reading.

The name of the frequency test depends on the selected Standard:

- **ANSI: VF Balance**
- **ITU: AC Balance**

Active

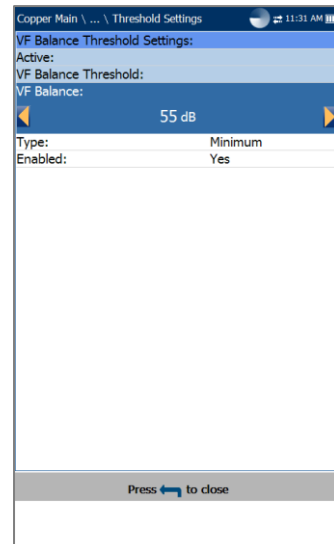
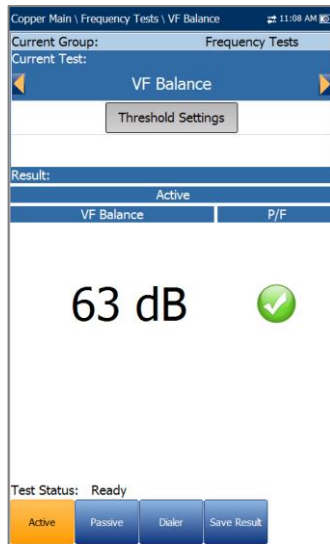

The **Active** function takes a balance measurement, displaying and updating results in *real time*, until you stop the test. The last valid results then remain displayed.



- **Current Group** is the current test group name, for example **Frequency Tests**.
- **Current Test** displays the test being measured. Here you can switch to another test from the given list. However, this action will terminate the ongoing measurement test.
- **Threshold Settings** button opens a new page that allows you to set the **VF/AC Balance** threshold.
- **Result** displays the pass/fail status and **Active VF/AC Balance** value.
- **Test Status** displays the current state of measurement or an error message.



*Note: The selected **Standard** in **Setup/Application Settings** determines the name of the frequency test - **ANSI: VF Balance, ITU: AC Balance**.*

To select the parameter values:

1. Press the up/down arrow keys to highlight the desired parameter.
2. Press the left/right arrow keys to view and select the options.
OR
3. Press  on a value to open a list box of options.
4. Press  to confirm the value.

- **VF/AC Balance** sets the active balance threshold.
- **Type** is the threshold limit: either **Maximum** or **Minimum**.
- **Enabled** is a flag to use the existing threshold: either **Yes** or **No**. For example, setting the threshold **Enabled** to **No** will disable pass/fail threshold.

To set threshold values:

1. Press the up/down arrow keys to highlight the desired parameter.
2. Press the left/right arrow keys to view and select the options.
OR
3. Press  on a value to open a list box of options or the alphanumeric editor screen and use the navigation keys to scroll through.
4. Press  to confirm the value.

VF/AC Balance Active Threshold Settings

The **Threshold Settings** page allows you to set the **Active VF/AC Balance Threshold** values for the test.

Active Result Details

The **Active Results Details** read-only page displays the **VF/AC Balance** value and the pass/fail status.

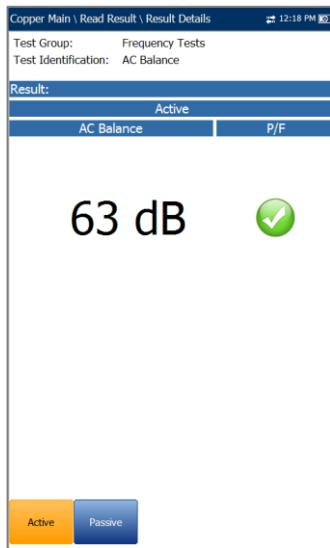

Passive

The **Passive** function computes the passive balance as the difference between **Power Influence** and **VF Noise**, displaying and updating results in real time, until you stop the test.

The last valid results then remain displayed. The measurement results of the active and passive VF Longitudinal Balance tests will generally be different due to the fact they use different measurement techniques.

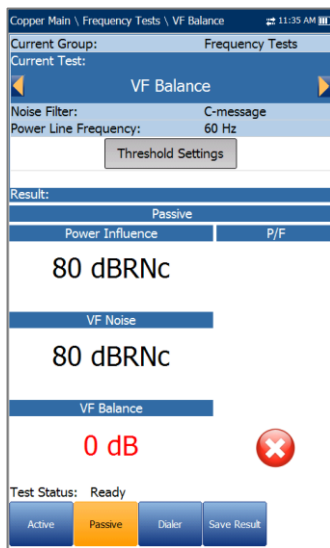



- **Current Group** is the current test group name, for example **Frequency Tests**.
- **Current Test** displays the test being measured. Here you can switch to another test

from the given list. However, this action will terminate the ongoing measurement test.

- **Noise Filter** displays the type of noise filter used.
- **Power Line Frequency** displays the frequency value of the power line.
- **Threshold Settings** button opens a new page that allows you to set the **VF/AC Balance Threshold**.
- Result displays the Passive pass/fail status, Power Influence, VF Noise, and VF/AC Balance values.
- **Test Status** displays the current state of measurement or an error message.

*Note: The selected **Standard** in **Setup/Application Settings** determines the name of the frequency test - **ANSI: VF Balance, ITU: AC Balance**.*

To select the parameter values:

1. Press the up/down arrow keys to highlight the desired parameter.
2. Press the left/right arrow keys to view and select the options.
OR
3. Press  on a value to open a list box of options.
4. Press  to confirm the value.

VF/AC Balance Passive Threshold Settings

The **Threshold Settings** page allows you to set the **Passive VF/AC Balance Threshold** values for the test.

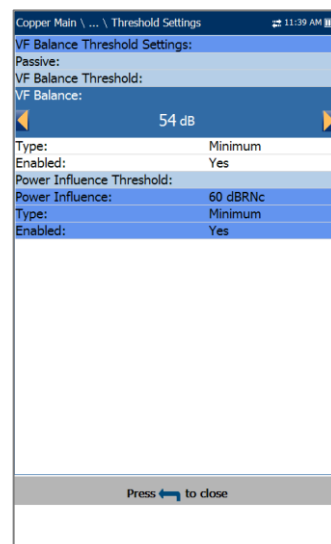

- **VF/AC Balance** sets the passive balance threshold.
- **Type** is the threshold limit: either **Maximum** or **Minimum**.
- **Enabled** is a flag to use the existing threshold: either **Yes** or **No**. For example, setting the threshold **Enabled** to **No** will disable pass/fail threshold.
- **Power Influence Threshold** displays the **Power Influence** threshold values set in relation to **VF/AC Balance** threshold values.

To set the passive VF/AC Balance threshold values:

1. Press the up/down arrow keys to highlight the desired parameter.
2. Press the left/right arrow keys to view and select the options.

OR
3. Press ✓ on a value to open a list box of options or the alphanumeric editor screen and use the navigation keys to scroll through.
4. Press ✓ to confirm the value.

Passive Result Details

The **Passive Results Details** read-only page displays the **Passive** pass/fail status, **Power Influence**, **VF Noise**, and **VF/AC Balance** values.

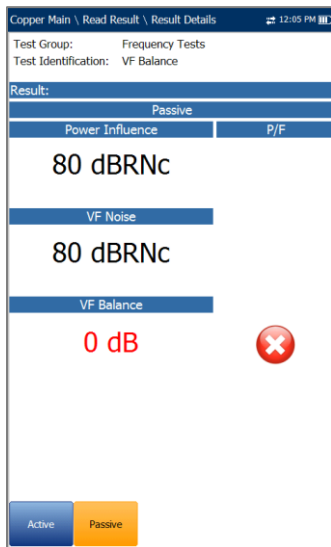

12.3 WB Balance

The wideband balance test ensures that the balance ratio for the twisted pair complies with applicable standards so as to reduce the effects of common-mode voltage to ground. The better the balance of the cable pair, the higher the dB reading. The test measures the WB balance at fixed and periodic frequencies dependent on the selected bandwidth.

Balance

The Balance page allows you to configure the parameters for the WB Balance test and view the results, in either Portrait or Landscape Mode.

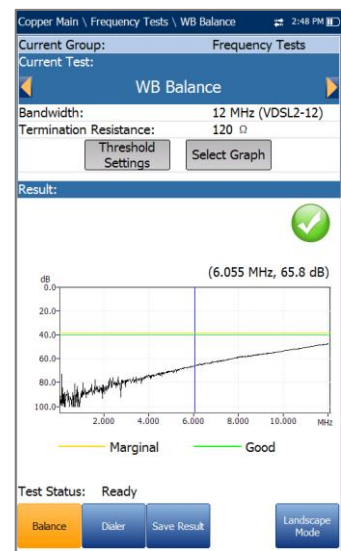

- **Current Group** is the current test group name, for example **Frequency Tests**.
- **Current Test** displays the test being measured. Here you can switch to another test from the given list. However, this action will terminate the ongoing measurement test.
- **Bandwidth** allows you to select the frequency range for the test from a list of available bandwidth: **ISDN**, **HDSL**, **SHDSL**, **ADSL1/2**, **ADSL2+**, **VDSL2-8**, **VDSL2-12**, or **VDSL2-17**.
- **Termination Resistance** defines the resistance of the dummy load connected to the line.
- **Threshold Settings** button opens a new page that allows you to set the **WB Balance Thresholds**.
- **Select Graph** button changes to **Graph Selected** when pressed and opens a new selection of function keys which allow you to maneuver the graph as follows:
 - **Cursor** - press the left/right arrow keys to decrease/increase the values by

moving the cursor. Press and hold the left/right arrow keys to accelerate the cursor. Press  to recall the cursor and place it in the middle of the current x-axis limits.

- **Zoom** references the middle of the x/y axis and not the cursor position. Press the arrow keys as follows:

Right = x-axis zoom in.

Left = x-axis zoom out.

Up = y-axis zoom in.

Down = y-axis zoom out.

- **Pan** - use left/right arrow keys to pan the x-axis and the up/down arrow keys to pan the y-axis.
- **1:1** resets the x-axis and y-axis limits to full scale.
- **Return To Test** removes these function keys and displays the previous ones.

- **Result** displays a graph of the **Marginal** and **Good** balance results, and pass/fail status. If any attenuation measurement (trace) is greater/less than the corresponding marginal test threshold for a maximum/minimum threshold, the status is fail. Otherwise, the status is pass.

- **Good** is the good balance threshold for the currently selected bandwidth, represented by a horizontal green line.
- **Marginal** is the marginal balance threshold for the currently selected bandwidth, represented by a horizontal yellow line.

If Mask is enabled for the selected bandwidth, then:

- **Marginal** is a marginal pass area on the graph represented in yellow.
- The end of tolerance or fail point is displayed as a red cursor value.

- **Test Status** displays the current state of measurement or an error message.

To select the parameter values in Portrait Mode:

1. Press the up/down arrow keys to highlight the desired parameter.
2. Press the left/right arrow keys to view and select the options.

OR

3. Press  on a value to open a list box of options.

4. Press  to confirm the value.

- **Landscape Mode** function key allows you to view the test results in landscape mode. Whether the keyboard is on the right or left is dependent on your preferred **Landscape Mode Settings** configured in **Setup/Application Settings/General**.

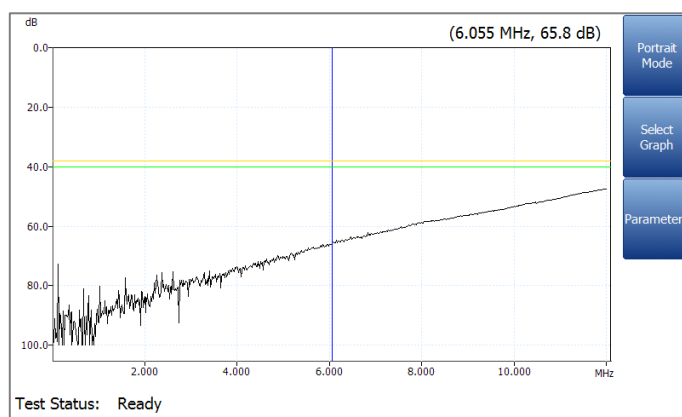

This mode generates the following function keys:

- **Portrait Mode** is used to change the screen orientation from landscape to portrait.
- **Select Graph** opens a new selection of function keys which allow you to maneuver the graph. (Same as above.)
- **Parameters** displays a small strip window when selected allowing you to change the **Bandwidth** and **Termination Resistance** values from a list of options.

To select the parameter values in Landscape Mode:

1. Press the Parameters function key.
2. Press the up/down arrow keys to highlight the desired parameter.
3. Press the left/right arrow keys to view and select the options.
4. Press  to confirm the value.

WB Balance Threshold Settings

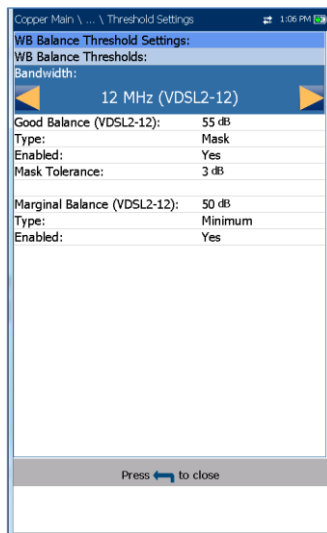

The **Threshold Settings** page allows you to set the **Good/Marginal Balance** thresholds for the following:

- **Bandwidth** allows you to select the frequency range for the test from a list of available bandwidth: **ISDN, HDSL, SHDSL, ADSL1/2, ADSL2+, VDSL2-8, VDSL2-12, or VDSL2-17.**
- **Type** is the threshold limit for each pair. Selecting **Minimum** or **Maximum** acts as the single point **P/F** threshold *flat* mask while selecting **Mask** provides a *shaped* mask as threshold. When **Mask** is selected, it will be used as pass/fail criteria next time the test is run.
- **Enabled** is a flag to use the existing threshold: either **Yes** or **No**. For example, setting the threshold **Enabled** to **No** will disable pass/fail threshold.
- **Mask Tolerance** allows you to set a marginal pass value which will be displayed on the graph in yellow.

To set threshold values:

1. Press the up/down arrow keys to highlight the desired parameter.
2. Press the left/right arrow keys to view and select the options.
OR
3. Press on a value to open a list box of options or the alphanumeric editor screen and use the navigation keys to scroll through.
4. Press to confirm the value.

Result Details

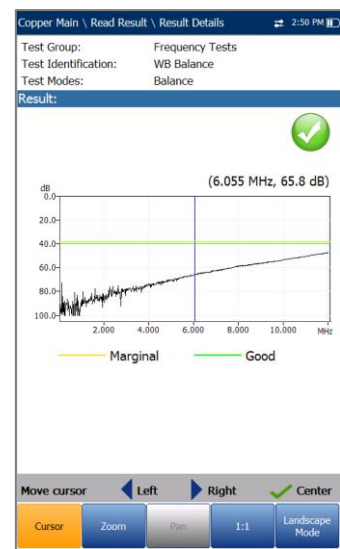

The **Results Details** displays a graph of the **Marginal** and **Good** wideband balance results, and pass/fail status. Results can be viewed in portrait and landscape modes. You can maneuver the graph as follows:

- **Cursor** - press the left/right arrow keys to decrease/increase the values by moving the cursor. Press and hold the left/right arrow keys to accelerate the cursor. Press to recall the cursor and place it in the middle of the current x-axis limits.
- **Zoom** references the middle of the x/y axis and not the cursor position. Press the arrow keys as follows:
 - Right = x-axis zoom in.
 - Left = x-axis zoom out.
 - Up = y-axis zoom in.
 - Down = y-axis zoom out.
- **Pan** - use left/right arrow keys to pan the x-axis and the up/down arrow keys to pan the y-axis.
- **1:1** resets the x-axis and y-axis limits to full scale.
- **Landscape Mode** function key allows you to view the test results in landscape mode. Whether the keyboard is on the right or left is dependent on your preferred **Landscape Mode Settings** configured in **Application Settings/General**.
- **Portrait Mode** is used to change the screen orientation from landscape to portrait.

12.4 WB Attenuation

Attenuation

The WB (wideband) single-ended attenuation test allows you to calculate the dissipation of power of a transmitted signal as it travels over the copper line.

This test is performed from one end of the cable and does not require a remote second device. The test does require an out-of-service wire pair that is open at the far end. Faults should be repaired first.

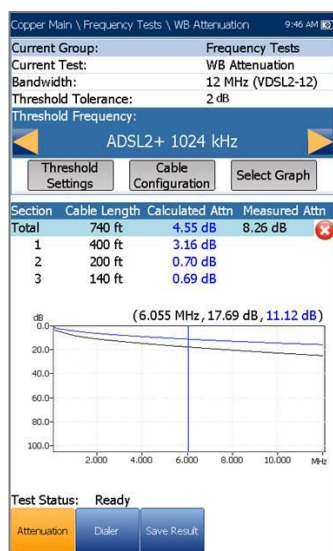

- **Current Group** is the current test group name, for example **Frequency Tests**.
- **Current Test** displays the test being measured. Here you can switch to another test from the given list. However, this action will terminate the ongoing measurement test.
- **Bandwidth** allows you to select the frequency range for the test from a list of available bandwidths: **ISDN, HDSL, SHDSL, ADSL1/2, ADSL2+, VDSL2-8, VDSL2-12, VDSL2-17, VDSL2-30, or VDSL2-35**.
- **Threshold Tolerance** allows you to set a marginal pass value which will be displayed on the graph in yellow.
- **Threshold Frequency** allows you to add threshold calculations to the **WB Attenuation** test by selecting a technology that is used for threshold pass/fail estimation. The list of technologies is dynamically populated based on the selected **Bandwidth**. Whenever you change the **Bandwidth**, the **Threshold Frequency** is set to the default **None**.
- **Threshold Settings** button opens a new page that allows you to set the **Attenuation** threshold.

- **Cable Configuration** button opens a new page that allows you to set cable parameters for the **Current Test**.
- **Select Graph** button changes to **Graph Selected** when pressed and opens a new selection of function keys which allow you to maneuver the graph as follows:
 - **Cursor** - press the left/right arrow keys to decrease/increase the values by moving the cursor. Press and hold the left/right arrow keys to accelerate the cursor. Press to recall the cursor and place it in the middle of the current x-axis limits.
 - **Zoom** references the middle of the x/y axis and not the cursor position. Press the arrow keys as follows:
 - Right = x-axis zoom in.
 - Left = x-axis zoom out.
 - Up = y-axis zoom in.
 - Down = y-axis zoom out.
 - **Pan** - use left/right arrow keys to pan the x-axis and the up/down arrow keys to pan the y-axis.
 - **1:1** resets the x-axis and y-axis limits to full scale.
 - **Return To Results** removes these function keys and displays the **Attenuation** page.
- **Result** displays the **Cable Length**, pass/fail status, and test results in text and graphical format. If a **Threshold Frequency** was selected (other than **None**), the calculations are presented in 2 ways:
 - An attenuation vs. frequency curve is added to the graph
 - A table displaying the **Total** equivalent **Calculated Attn** and the **Measured Attn** at the frequency, specific to the selected technology; and up to 4 rows displaying information calculated for each **Section** identified on **Cable Configuration** page.
 - The **Calculated Attn** is the sum of the section attenuations and is shown in blue.
 - The **Measured Attn** displays the measured attenuation for the frequency set in the **Threshold Settings**, and is shown in black.

The pass/fail criteria is calculated by comparing **Measured Attn** to the equivalent attenuation value displayed in

the **Calculated Attn**, plus half of the **Threshold Tolerance**.

When Mask is enabled for the selected bandwidth:

- The end of tolerance or fail point is displayed as a red cursor value.
 - **Good** is the good balance threshold mask for the currently selected bandwidth, represented by green in the graph.
- **Test Status** displays the current state of measurement or an error message.

To select the parameter values:

1. Press the up/down arrow keys to highlight the desired parameter.
 2. Press the left/right arrow keys to view and select the options.
- OR
3. Press ✓ on a value to open a list box of options or the alphanumeric editor screen and use the navigation keys to scroll through.
 4. Press ✓ to confirm the value.

WB Attenuation Threshold Settings

The **Threshold Settings** page allows you to set the **WB Attenuation** threshold values for the test.

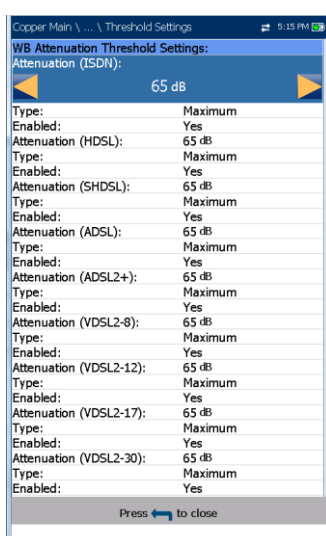

- **Attenuation** sets up the good attenuation threshold parameters.
- **Type** is the threshold limit for each pair. Selecting **Minimum** or **Maximum** acts as the

single point pass/fail threshold *flat* mask while selecting **Mask** provides a *shaped* mask as threshold. When **Mask** is selected, it will be used as pass/fail criteria next time the test is run.

- **Enabled** is a flag to use the existing threshold: either **Yes** or **No**. For example, setting the threshold **Enabled** to **No** will disable pass/fail threshold.

To set threshold values:

1. Press the up/down arrow keys to highlight the desired parameter.
 2. Press the left/right arrow keys to view and select the options.
- OR
3. Press ✓ on a value to open a list box of options or the alphanumeric editor screen and use the navigation keys to scroll through.
 4. Press ✓ to confirm the value.

Cable Configuration

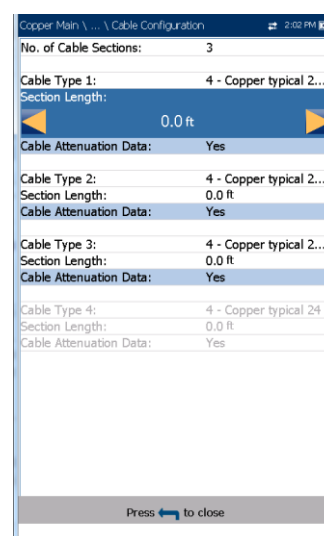

The **Cable Configuration** page is only required if using theoretical calculated attenuation pass/fail. The page allows you to set cable parameters for the **WB Attenuation** test. Each time the **Cable Configuration** is changed, the total equivalent attenuation table will be recalculated and redrawn.



- **No. of Cable Sections** allows you to set the number of consecutive cable sections, to a maximum of 4. If unknown, set the number to 1.

- **Cable Type #** displays the number of a cable section set above, ID, Cable Name and Fill, and allows you to select an entry (with its associated parameters) from the current Cable Book, to use for testing.
- For each section, the selected **Cable Type** must have attenuation data available or else the total equivalent attenuation cannot be calculated. The selection is not saved when leaving the test. The current Cable Book entry is shown by default.
- **Section Length** specifies the cable length of each section. The total length for all cable sections cannot exceed 8000 m or 24000 ft. If you do not enter a length for each section selected, the total equivalent attenuation cannot be calculated.
- **Cable Attenuation Data** is set to **Yes** for each cable section selected.

To select the parameter values:

1. Press the up/down arrow keys to highlight the desired parameter.
2. Press the left/right arrow keys to view and select the options.
OR
3. Press  on a value to open a list box of options or the alphanumeric editor screen and use the navigation keys to scroll through.
4. Press  to confirm the value.

WB Attenuation Result Details

The Results Details read-only page displays the Cable Length, pass/fail status, and WB Attenuation test results in text and graphical format.

- **Test Group** is the overall test group of the selected saved results file, for example **Frequency Tests**.
- **Test Identification** is the test type of the group, for example **WB Attenuation**.
- **Test Modes** is the mode of test, for example **Attenuation**.
- **Threshold Frequency** displays the technology used for threshold pass/fail estimation.
- **Cable Configuration** button opens a new page displaying the cable parameters of the test. Use the left/right arrows to select the button and press  to open the page.

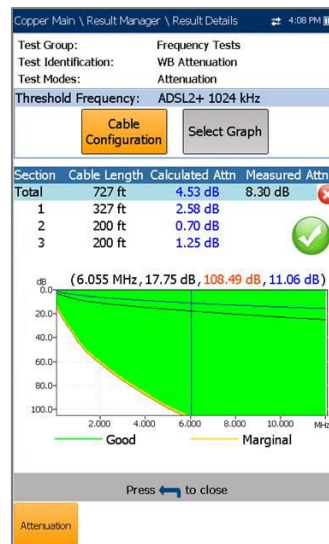

- **Select Graph** button changes to **Graph Selected** when pressed and opens a new selection of function keys which allow you to maneuver the graph as follows:
 - **Cursor** - press the left/right arrow keys to decrease/increase the values by moving the cursor. Press and hold the left/right arrow keys to accelerate the cursor. Press  to recall the cursor and place it in the middle of the current x-axis limits.
 - **Zoom** references the middle of the x/y axis and not the cursor position. Press the arrow keys as follows:
 - Right = x-axis zoom in.
 - Left = x-axis zoom out.
 - Up = y-axis zoom in.
 - Down = y-axis zoom out.
 - **Pan** - use left/right arrow keys to pan the x-axis and the up/down arrow keys to pan the y-axis.
 - **1:1** resets the x-axis and y-axis limits to full scale.
 - **Return To Results** removes these function keys and displays the **Attenuation** results page.

When Mask was enabled for the selected bandwidth:

- The end of tolerance or fail point may be displayed as a red cursor value.
- **Good** is the good balance threshold mask for the currently selected bandwidth, represented by green in the graph.

Result Details Cable Configuration

The **Cable Configuration** page in the **Results Details** allows you to view the cable parameters set for the **WB Attenuation** test.

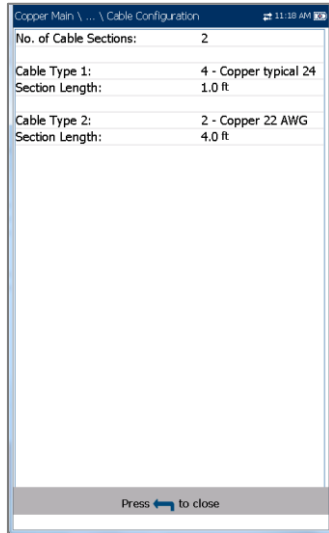

- **No. of Cable Sections** is the number of consecutive cable sections, with a maximum of 4.
- **Cable Type #** displays the number of a cable section set above, ID, Cable Name and Fill.
- **Section Length** identifies the cable length of each section.

12.5 Return Loss

The Return Loss test allows you to measure the loss of power in the signal returned/reflected by a discontinuity in a transmission line. This discontinuity or impedance variation can be a mismatch with the terminating load or with a device inserted in the line.

A small value dBRL number means that most of the pulse energy is reflected by the cable fault. An open or short would reflect all the energy so its return loss is zero.

Remember, the larger the dBRL reading, the smaller the problem and vice versa.

Single Frequency

The **Single Frequency** test is continuous, and allows you to configure parameters and change values during the measurement. The page provides a **Return Loss** result value in dB, and pass/fail status.

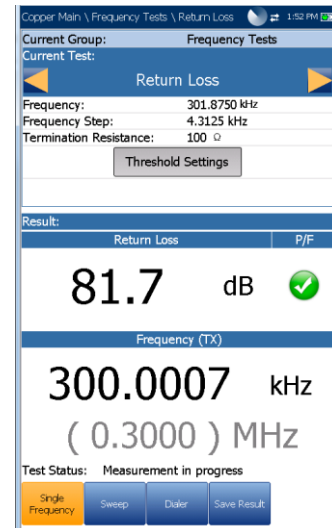

- **Current Group** is the current test group name, for example **Frequency Tests**.
- **Current Test** displays the test being measured. Here you can switch to another **Frequency** test from the given list. However, this action will terminate the ongoing measurement test.
- **Frequency** allows you to set the frequency value for the **Return Loss** test.
- **Frequency Step** lists a choice of frequency step values.
- **Termination Resistance** lists a choice of resistance values for the termination of the signal.
- **Threshold Settings** button opens a new page that allows you to set **Return Loss** thresholds for the transmission.
- **Result** displays the pass/fail status, **Return Loss** and **Frequency (TX)** values.
- **Test Status** displays the current state of measurement or an error message.

To select the parameter values:

1. Press the up/down arrow keys to highlight the desired parameter.
2. Press the left/right arrow keys to view and select the options.
OR
3. Press ✓ on a value to open a list box of options or the alphanumeric editor screen and use the navigation keys to scroll through.
4. Press ✓ to confirm the value.

Return Loss Threshold Settings

The **Return Loss Threshold Settings** page allows you to set the **Loss Threshold** for each pair. The threshold is a programmable value you can use as an on-screen indicator in each test when a measured value is too high or too low.

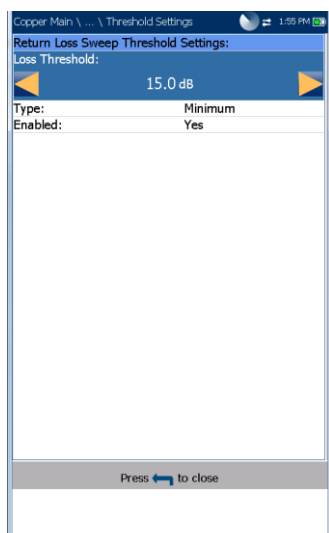



- **Type** is the threshold limit for each pair: either **Maximum** or **Minimum**.
- **Enabled** is a flag to use the **Return Loss** threshold: either **Yes** or **No**. For example, setting the threshold **Enabled** to **No** will disable pass/fail threshold.

To set threshold values:

1. Press the up/down arrow keys to highlight the desired parameter.
2. Press the left/right arrow keys to view and select the options.

OR

3. Press  on a value to open a list box of options or the alphanumeric editor screen and use the navigation keys to scroll through.
4. Press  to confirm the value.

Single Frequency Result Details

The **Results Details** read-only page displays the pass/fail status, **Return Loss** and **Frequency (TX)** values.

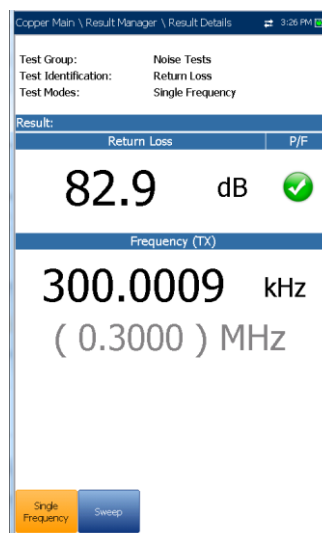

Sweep

The **Sweep** test allows you to configure parameters and provides a snapshot measurement of **Return Loss** in a graphical format, and pass/fail status.

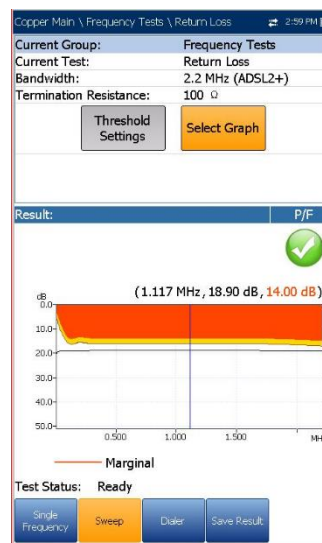

- **Current Group** is the current test group name, for example **Frequency Tests**.
- **Current Test** displays the test being measured. Here you can switch to another Frequency test from the given list. However, this action will terminate the ongoing measurement test.
- **Bandwidth** allows you to select the frequency range for the test from a list of available bandwidths: **ISDN**, **HDSL**, **SHDSL**, **ADSL1/2**, or **ADSL2+**.
- **Termination Resistance** lists a choice of resistance values for the termination of the signal.

- **Threshold Settings** button opens a new page that allows you to set **Return Loss** thresholds for the transmission.
- **Select Graph** button changes to **Graph Selected** when pressed and opens a new selection of function keys which allow you to maneuver the graph as follows:
 - **Cursor** - press the left/right arrow keys to decrease/increase the values by moving the cursor. Press and hold the left/right arrow keys to accelerate the cursor. Press ✓ to recall the cursor and place it in the middle of the current x-axis limits.
 - **Zoom** references the middle of the x/y axis and not the cursor position. Press the arrow keys as follows:
 - Right = x-axis zoom in.
 - Left = x-axis zoom out.
 - Up = y-axis zoom in.
 - Down = y-axis zoom out.
 - **Pan** - use left/right arrow keys to pan the x-axis and the up/down arrow keys to pan the y-axis.
 - **1:1** resets the x-axis and y-axis limits to full scale.
 - **Return To Test** removes these function keys and displays the **Detection** page.
- **Result** displays the pass/fail status and a graph of the **Return Loss Sweep** compared to **Marginal** results. If the measurement is greater/less than the marginal test threshold, represented by a horizontal red line, the status is fail. Otherwise, the status is pass.
- **Test Status** displays the current state of measurement or an error message.

To select the parameter values:

1. Press the up/down arrow keys to highlight the desired parameter.
2. Press the left/right arrow keys to view and select the options.
OR
3. Press ✓ on a value to open a list box of options.
4. Press ✓ to confirm the value.

Sweep Threshold Settings

The **Return Loss Sweep Threshold Settings** page is similar to the **Single Frequency** test and allows you to set the **Loss Threshold** for each pair.

In addition, you can select **Mask** as a threshold and view the **Mask Tolerance**. The threshold is a programmable value you can use as an on-screen indicator in each test when a measured value is too high or too low.

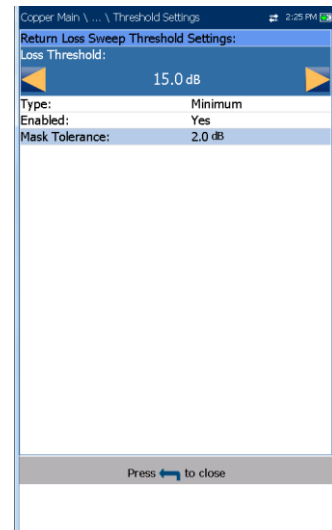

- **Type** is the threshold limit for each pair. Selecting **Minimum** or **Maximum** acts as the single point **P/F** threshold *flat* mask while selecting **Mask** provides a *shaped* mask as threshold. When **Mask** is selected, it will be used as pass/fail criteria next time the test is run, and **Loss Threshold** becomes read-only.
- **Enabled** is a flag to use the **Return Loss** threshold: either **Yes** or **No**. For example, setting the threshold **Enabled** to **No** will disable pass/fail threshold.
- **Mask Tolerance** is a fixed value representing a marginal pass area on the graph shown in yellow.

To set threshold values:

1. Press the up/down arrow keys to highlight the desired parameter.
2. Press the left/right arrow keys to view and select the options.
OR
3. Press ✓ on a value to open a list box of options or the alphanumeric editor screen and use the navigation keys to scroll through.
4. Press ✓ to confirm the value.

Sweep Result Details

The **Sweep Result Details** read-only page displays the pass/fail status and test results in graphical format.

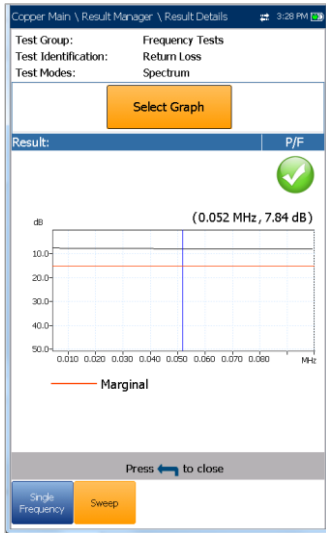

- **Test Group** is the overall test group of the selected saved results file, for example **Frequency Tests**.
- **Test Identification** is the test type of the group, for example **Return Loss**.
- **Test Modes** is the mode of test, for example **Sweep**.
- **Select Graph** button opens a new selection of function keys which allow you to maneuver the graph as follows:
 - **Cursor** - press the left/right arrow keys to decrease/increase the values by moving the cursor. Press and hold the left/right arrow keys to accelerate the cursor. Press to recall the cursor and place it in the middle of the current x-axis limits.
 - **Zoom** references the middle of the x/y axis and not the cursor position. Press the arrow keys as follows:
 - Right = x-axis zoom in.
 - Left = x-axis zoom out.
 - Up = y-axis zoom in.
 - Down = y-axis zoom out.
 - **Pan** - use left/right arrow keys to pan the x-axis and the up/down arrow keys to pan the y-axis.
 - **1:1** resets the x-axis and y-axis limits to full scale.

- **Return To Test** removes these function keys and returns to the **Spectrum** results page.

Return Loss Profile Details

The **Profile Details** page displays read-only **Return Loss Test Thresholds/Parameters** for both **Single Frequency** and **Sweep**.

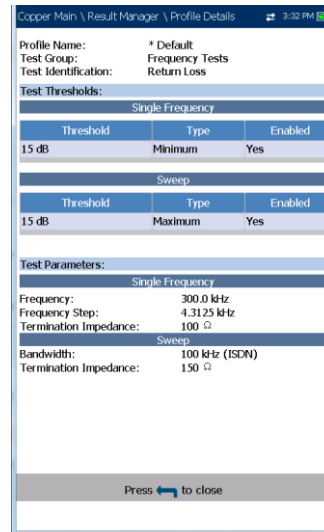

- **Profile Name** is the file name of the selected saved results.
- **Test Group** is the overall test group of the selected saved results file, for example **Frequency Tests**.
- **Test Identification** is the test type of the group, for example **Return Loss**.

12.6 Load Coils

The Load Coils test allows you to detect the presence of load coils, which are detrimental to the use of DSL technologies on the line. If a load coil is detected, use the TDR (time domain reflectometer) test to quickly locate and remove it from the cable.

Detection

The **Detection** function specifies the presence or absence of load coil in the cable section, and displays the number of load coils in the line and measured values in graphical form.

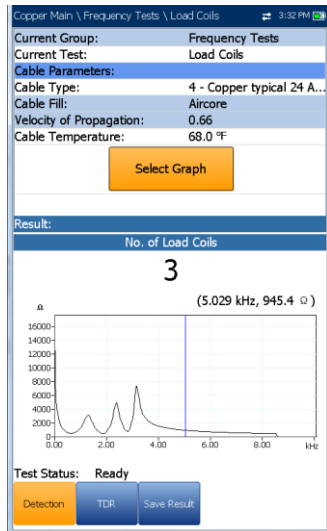

- **Current Group** is the current test group name, for example **Frequency Tests**.
- **Current Test** displays the test being measured. Here you can switch to another test from the given list. However, this action will terminate the ongoing measurement test.

- **Cable Parameters:**

- **Cable Type** displays the ID, Cable Name and Fill, and allows you to select an entry (with its associated parameters) from the current Cable Book, to use for testing. The selection is not saved when leaving the test. The current Cable Book entry is shown by default.
- **Cable Fill** read-only entry is the type of material the cable is filled with: **Aircore, Jelly, Pulp, 5 PR,** or **2 PR.** Setup in the Cable Book.
- **Velocity of Propagation** read-only entry is the velocity of propagation for the cable. Setup in the **Cable Book.**
- **Cable Temperature** allows you to change the temperature of the cable under test in either **°F** or **°C**.

- **Select Graph** button changes to **Graph Selected** when pressed and opens a new selection of function keys which allow you to maneuver the graph as follows:

- **Cursor** - press the left/right arrow keys to decrease/increase the values by moving the cursor. Press and hold the left/right arrow keys to accelerate the cursor. Press ✓ to recall the cursor and place it in the middle of the current x-axis limits.

- **Zoom** references the middle of the x/y axis and not the cursor position. Press the arrow keys as follows:

Right = x-axis zoom in.

Left = x-axis zoom out.

Up = y-axis zoom in.

Down = y-axis zoom out.

- **Pan** - use left/right arrow keys to pan the x-axis and the up/down arrow keys to pan the y-axis.
- **1:1** resets the x-axis and y-axis limits to full scale.
- **Return To Test** removes these function keys and displays the **Detection** page.

- **Result** displays the number of load coils in text and graphical format.
- **Test Status** displays the current state of measurement or an error message.

To select the parameter values:

1. Press the up/down arrow keys to highlight the desired parameter.
2. Press the left/right arrow keys to view and select the options.
OR
3. Press ✓ on a value to open a list box of options or the alphanumeric editor screen and use the navigation keys to scroll through.
4. Press ✓ to confirm the value.

TDR

The Load Coils **TDR** function provides a shortcut to the TDR test. A dialog box opens, warning that you are about to leave the Load Coils test. TDR results captured while running Load Coils will be available upon loading TDR. Please go to [TDR](#) on page 117 for information on this test.

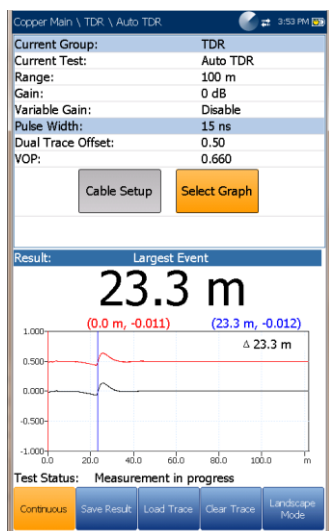

Load Coils Result Details

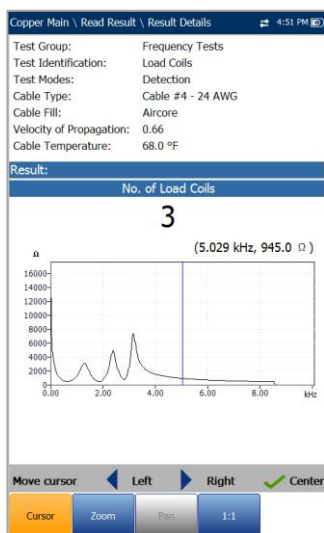

The **Results Details** read-only page displays the number of load coils, in text and graphical format. You can maneuver the graph as follows:

- **Cursor** - press the left/right arrow keys to decrease/increase the values by moving the cursor. Press and hold the left/right arrow keys to accelerate the cursor. Press  to recall the cursor and place it in the middle of the current x-axis limits.
- **Zoom** references the middle of the x/y axis and not the cursor position. Press the arrow keys as follows:
 - Right = x-axis zoom in.
 - Left = x-axis zoom out.
 - Up = y-axis zoom in.
 - Down = y-axis zoom out.

- **Pan** - use left/right arrow keys to pan the x-axis and the up/down arrow keys to pan the y-axis.
- **1:1** resets the x-axis and y-axis limits to full scale.

12.7 Locator Tone

When **Locator Tone** is selected from the **Frequency Tests** menu, a 577 Hz signal and a 983 Hz alternating signal are sent separately for 200 ms each. The sequence of this tone is repeated continuously until you stop the test. A sinusoidal waveform is used to generate these signals. Cable locators such as Radiodetection's RD8100 can detect 577 Hz as standard and can also be programmed to locate 983 Hz.

Tone

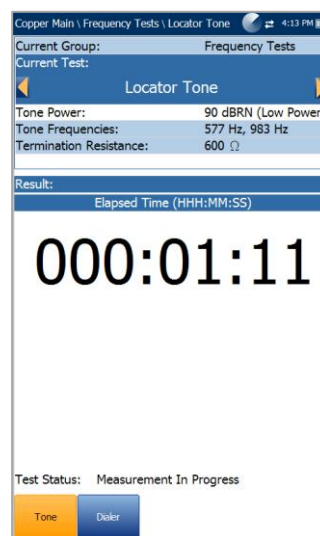

The **Tone** function allows you to set the **Tone Power** and generate a pulsed tone on the line to trace a cable pair at the far end.



- **Current Group** is the current test group name, for example **Frequency Tests**.
- **Current Test** displays the test being measured. Here you can switch to another test from the given list. However, this action will terminate the ongoing measurement test.
- **Tone Power** allows you to select either low or high power for the **Locator Tone**.
- **Tone Frequencies** displays the frequencies of the **Locator Tone**.
- **Termination Resistance** is a read-only value of **600 Ω**.
- **Result** displays the Elapsed Time the locator tone is being sent.

- **Test Status** displays the current state of measurement or an error message.

To select the parameter values:

1. Press the up/down arrow keys to highlight the desired parameter.
2. Press the left/right arrow keys to view and select the options.
3. *OR*
4. Press  on a value to open a list box of options.
5. Press  to confirm the value.

12.8 TX/RX Tone

The **TX/RX** Tone tests allow you to generate tones and measure the frequencies and levels of incoming signals.

Send Tone

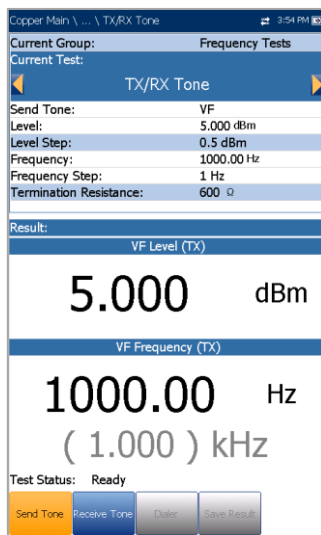

The **Send Tone** (TX) pane allows you to configure and transmit a tone to a downstream device in the loop.



- **Current Group** is the current test group name, for example **Frequency Tests**.
- **Current Test** displays the test being measured. Here you can switch to another frequency test from the given list. However, this action will terminate the ongoing measurement test.
- **Send Tone** allows you to select either a **VF** (voice frequency) or **WB** (wideband) signal (if this option was purchased).

- **Level** allows you to set the tone level value.
- **Level Step** (read only) displays the level step of the uplink frequency.
- **Frequency** allows you to set a frequency value for the transmitting tone.
- **Frequency Step** lists a choice of frequency step values.
- **Termination Resistance** lists a resistance value for the termination of the Send Tone.
- **Result** displays the values for both the **TX VF/WB Level** and **VF/WB Frequency**.
- **Test Status** displays the current state of measurement or an error message.

To select the parameter values:

1. Press the up/down arrow keys to highlight the desired parameter.
2. Press the left/right arrow keys to view and select the options.
OR
3. Press  on a value to open a list box of options or the alphanumeric editor screen and use the navigation keys to scroll through.
4. Press  to confirm the value.

Receive Tone

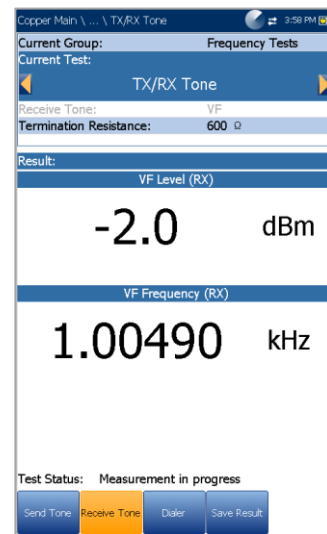

The **Receive Tone** (RX) tab allows you to configure and run a receive tone test, which measures the frequency and level of incoming signals.



- **Current Group** is the current test group name, for example **Frequency Tests**.

- **Current Test** displays the test being measured. Here you can switch to another frequency test from the given list. However, this action will terminate the ongoing measurement test.
- **Receive Tone** allows you to select either a **VF** (voice frequency) or **WB** (wideband) signal.
- **Termination Resistance** lists a resistance value for the termination of the **Receive Tone**.
- **Result** displays the values for both the **RX VF/WB Level** and **VF/WB Frequency**.
- **Test Status** displays the current state of measurement or an error message.

To select the parameter values:

1. Press the up/down arrow keys to highlight the desired parameter.
2. Press the left/right arrow keys to view and select the options.
OR
3. Press  on a value to open a list box of options or the alphanumeric editor screen and use the navigation keys to scroll through.
4. Press  to confirm the value.

Result Details

The **Results Details** read-only page displays the saved receive tone or **RX VF/WB Level** and **VF/WB Frequency values**.

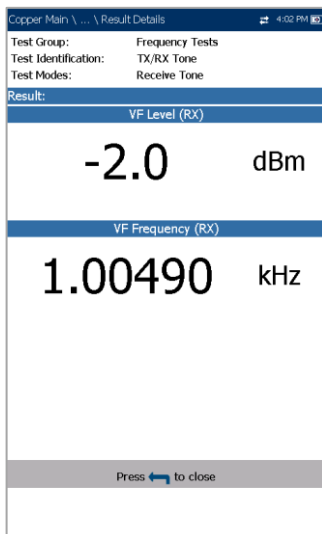

Profile Details Receive Tone

The **Profile Details** page displays read-only **Receive Tone Test Parameters**.

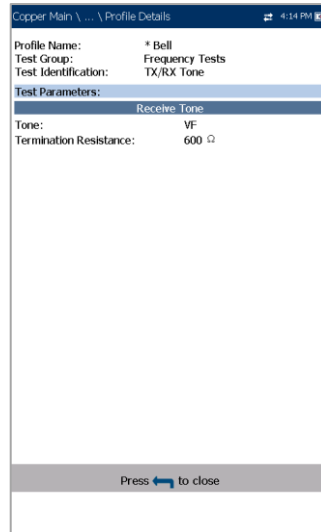

- **Tone** displays whether the receive tone was **VF** or **WB**.
- **Termination Resistance** is the resistance value selected for the termination of the **Receive Tone** test.

12.9 RX Tone with FED

The **RX Tone with FED** test can be setup to run a single frequency or run sequentially through a selected number of frequencies. The Teletech TS125 or Viavi UFED IIB Remote FED (far end device) is used and FED software option must be enabled on your unit. However, the test is not dependent on enabling the FED in FED Setup.

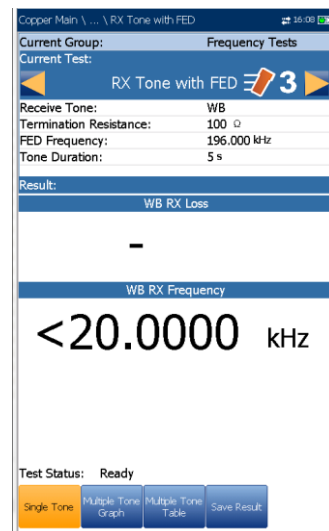

Single Tone



The **Single Tone** tab allows you to configure the following parameters:

- **Current Group** is the current test group name, for example **Frequency Tests**.
- **Current Test** displays the test being measured. Here you can switch to another Frequency test from the given list. However, this action will terminate the ongoing measurement test.
- **Receive Tone** allows you to select either a **VF** (voice frequency) or **WB** (wideband) signal. **WB** selection is only available when the **30 MHz Wideband Testing** software option is installed.
- **Termination Resistance** defines how much resistance the tester uses to connect to the line, and is set as follows:
 - for **VF Tone**, a read-only value of 600 Ω .
 - for **WB Tone**, select 100, 120, or 135 Ω .
- **FED Frequency** sets the frequency that the TS125 FED will transmit and is a value in Hz for **VF Receive Tone** (default 300 Hz) and kHz for **WB** (default 196 kHz).
- **Tone Duration** modifies the duration value of the tone from 5 - 60 seconds. Default is **5 s**.
- **Result** displays the values for both the RX VF/WB Loss and Frequency
- **Test Status** displays the current state of measurement or an error message.

To select the parameter values:

1. Press the up/down arrow keys to highlight the desired parameter.
2. Press the left/right arrow keys to view and select the options.
OR
3. Press  on a value to open a list box of options or the alphanumeric editor screen and use the navigation keys to scroll through.
4. Press  to confirm the value.

Single Tone Result Details

The **Result Details** read-only page displays the saved receive tone or **VF/WB RX Loss/Frequency** values for the **Single RX Tone with FED** test.

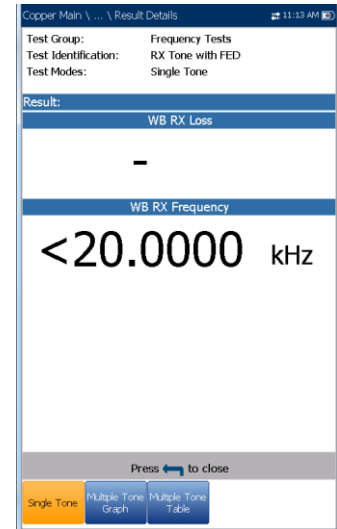

Multiple Tone Graph

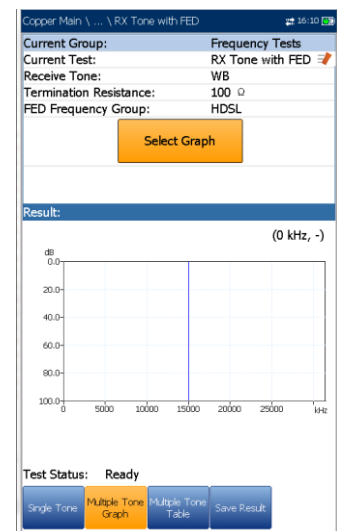

The **Multiple Tone Graph** tab displays results in text and graphical formats. From this page, you can run the **RX Tone with FED** test using multiple frequencies, by configuring the following parameters:

- **Current Group** is the current test group name, for example **Frequency Tests**.
- **Current Test** displays the test being measured. Here you can switch to another Frequency test from the given list. However, this action will terminate the ongoing measurement test.
- **Receive Tone** allows you to select either a **VF** (voice frequency) or **WB** (wideband) signal. **WB** selection is only available when the **30 MHz Wideband Testing** software option is installed.



- **Termination Resistance** defines how much resistance the tester uses to connect to the line, and is set as follows:
 - for **VF Receive Tone**, a read-only value of 600 Ω .
 - for **WB Receive Tone**, select 100, 120, or 135 Ω .
- **FED Frequency Group** allows you to select the frequency that the TS125 FED will transmit, from a preset list.
 - for VF Receive Tone:
 - POTS/PSTN: 404, 804, 1004, 1204, 1804, 2204, 2404, 2804, 3204, 3404 Hz
 - VF 5 Tone: 404, 1004, 2804, 3004, 3604 Hz
 - for WB Receive Tone:
 - HDSL: 20, 30, 50, 70, 90, 110, 130, 196, 400 kHz
 - T1/E1: 200, 400, 500, 700, 772, 1024 kHz
 - ADSL1/2+: 25, 69, 90, 110, 138, 300, 550, 800, 1104, 2208 kHz
 - VDSL2-12: 25, 138, 276, 3000, 3750, 5200, 8500, 12000 kHz
 - WB 5 Tone: 196, 392, 772, 1100, 2200 kHz

- **Select Graph** button changes to **Graph Selected** when pressed and opens a new selection of function keys which allow you to maneuver the graph as follows:
 - **Cursor** - press the left/right arrow keys to decrease/increase the values by moving the cursor. Press and hold the left/right arrow keys to accelerate the cursor. Press  to recall the cursor and place it in the middle of the current x-axis limits.
 - **Zoom** references the middle of the x/y axis and not the cursor position. Press the arrow keys as follows:
 - Right = x-axis zoom in.
 - Left = x-axis zoom out.
 - Up = y-axis zoom in.
 - Down = y-axis zoom out.
 - **Pan** - use left/right arrow keys to pan the x-axis and the up/down arrow keys to pan the y-axis.
 - **1:1** resets the x-axis and y-axis limits to full scale.

- **Return To Test** removes these function keys and displays the test page.

- **Result** displays the values for both the RX VF/WB Loss and Frequency.
- **Test Status** displays the current state of measurement or an error message.

To select the parameter values:

1. Press the up/down arrow keys to highlight the desired parameter.
 2. Press the left/right arrow keys to view and select the options.
- OR
3. Press  on a value to open a list box of options and use the navigation keys to scroll through.
 4. Press  to confirm the value.

Multiple Tone Graph Result Details

The **Result Details** read-only page displays the RX VF/WB Loss and Frequency results in graphical format for the **Multiple RX Tone with FED** test.

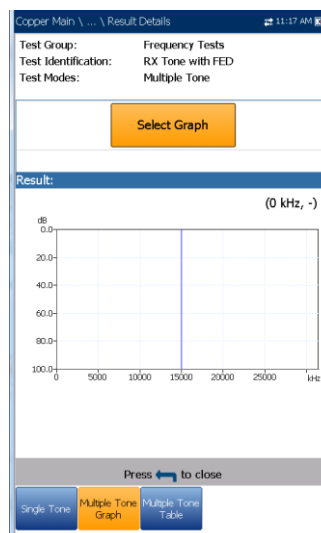

- **Test Group** is the overall test group of the selected saved results file, for example **Frequency Tests**.
- **Test Identification** is the test type of the group, for example **RX Tone with FED**.
- **Test Modes** is the mode of test, for example **Multiple Tone**.
- **Select Graph** button changes to **Graph Selected** when pressed and opens a new

selection of function keys which allow you to maneuver the graph as follows:

- **Cursor** - press the left/right arrow keys to decrease/increase the values by moving the cursor. Press and hold the left/right arrow keys to accelerate the cursor. Press  to recall the cursor and place it in the middle of the current x-axis limits.
- **Zoom** references the middle of the x/y axis and not the cursor position. Press the arrow keys as follows:
 Right = x-axis zoom in.
 Left = x-axis zoom out.
 Up = y-axis zoom in.
 Down = y-axis zoom out.
- **Pan** - use left/right arrow keys to pan the x-axis and the up/down arrow keys to pan the y-axis.
- **1:1** resets the x-axis and y-axis limits to full scale.
- **Return To Test** removes these function keys and returns to the test results page.

- VF 5 Tone: 404, 1004, 2804, 3004, 3604 Hz
- For WB Receive Tone:
 - HDSL: 20, 30, 50, 70, 90, 110, 130, 196, 400 kHz
 - T1/E1: 200, 400, 500, 700, 772, 1024 kHz
 - ADSL1/2+: 25, 69, 90, 110, 138, 300, 550, 800, 1104, 2208 kHz
 - VDSL2-12: 25, 138, 276, 3000, 3750, 5200, 8500, 12000 kHz
 - WB 5 Tone: 196, 392, 772, 1100, 2200 kHz

Multiple Tone Table

The **Multiple Tone Table** displays the **RX Frequency/Loss** for the **FED Frequency Group** selected.

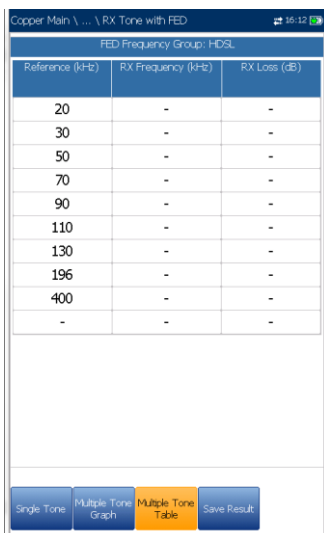

Reference (kHz)	RX Frequency (kHz)	RX Loss (dB)
20	-	-
30	-	-
50	-	-
70	-	-
90	-	-
110	-	-
130	-	-
196	-	-
400	-	-
-	-	-

- For VF Receive Tone:
 - POTS/PSTN: 404, 804, 1004, 1204, 1804, 2204, 2404, 2804, 3204, 3404 Hz

Profile Details

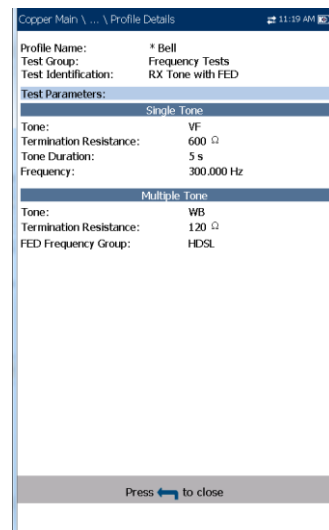

The **Profile Details** page displays read-only **Test Parameters** for both the Single and Multiple RX Tone with FED tests, and may contain the following entries:

- **Profile Name** (only displayed in Results Manager) is the file name of the selected saved results.
- **Test Group** is the overall test group of the selected saved results file, for example **Frequency Tests**.
- **Test Identification** is the test type of the group, for example **RX Tone with FED**.

Section 13 TDR

The **TDR** (time domain reflectometer) test is a useful tool to locate cable faults. The test is used after a fault has been identified by running other tests, since TDR reacts to all faults and conditions on a typical cable pair, revealing multiple events, some of which may be acceptable conditions.

TDR can see events as close as the ends of the test leads. The graph controls allow you to see the reflections and their distances so that you can find and resolve faults; you can view the graph in either **Portrait** or **Landscape Mode**.

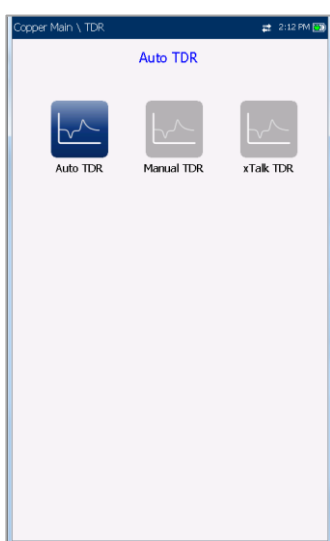

There are 3 modes of operation to choose from:

1. **Auto TDR** automatically searches and determines the length of the cable, finds the nearest significant event, and optimizes the ranges, pulse width, and gain. **Range** and **Gain** are updated to reflect the optimized TDR settings but can be edited.
Auto TDR displays the distance for the **Largest Event** and updates results in *real time*, until you stop the test. The last valid results then remain displayed.
2. **Manual TDR** does not automate any function nor settings and gives you full control over TDR parameters such as **Range**, **Gain**, **VOP**, and **Pulse Width**.
The test displays results in graphical format, updating them in real time, until you stop the test. The last valid results then remain displayed.
3. **xTalk** (crosstalk) **TDR** allows you to locate split pairs between tip (A) and ring (B) copper wires which may be causing service disruptions. The

test transmits on pair one and receives on pair two to locate the split pairs.

To select and run a test:

1. Press the left/right navigation keys to select the desired icon.
2. Press  to run the test.

13.1 Continuous

The **Continuous** function displays the line trace and is continuously on and ready to use. It displays and updates results in *real time*, in either **Portrait** or **Landscape Mode**, until you stop the test.

The last valid results then remain displayed. (Scroll down to see examples of some common faults on the TDR.)

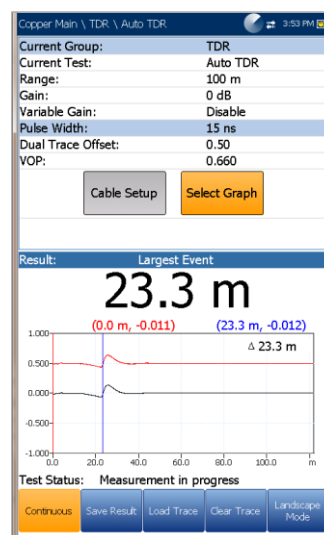

- **Current Group** displays the test being measured.
- **Current Test** allows you to select either **Auto**, **Manual**, or **xTalk TDR**.

Note: If you run Auto TDR first, and use the left/right arrow keys to change the Current Test from Auto TDR to Manual TDR, the test will copy the TDR parameters from the Auto TDR to the Manual TDR, but not to xTalk TDR.

- **Range** allows you to set the range from the given list.
- **Gain** allows you to select a gain test parameter from the given list.
- **Variable Gain (Auto TDR only)**, when enabled, automatically increases the amplitude gain as distance increases on the graph. In this

way, you do not have to tweak the gain just to see events at the far end.

- Select from 4 possible entries:
 - Disabled
 - Enabled
 - Disabled with Auto Scale
 - Enabled with Auto Scale

Use Auto Scale to easily capture and see the detected Largest Event applying automatic scaling of the amplitude of the trace in the vertical axis.

- **Pulse Width** is a non-editable value in **Auto TDR** but can be selected from a given list in **Manual** and **xTalk TDR**.
- **Dual Trace Offset %** is a configurable offset parameter for the secondary trace, with a range of -100 % to +100 %.

Note: If the loaded secondary trace offset = 0, then the primary and secondary traces will overlap.

- **VOP** allows you to change the velocity of propagation value for the cable.
- **Current Trace** (available only in Manual TDR) allows you to turn on/off **Live** and **Peak** traces and calculates the **Differential** trace. Select one of the following:
 - **Live** turns Peak Hold off clearing previously collected minimum/maximum measurement values. This is the default.
 - **Live and Peak** turns Peak Hold on and collects minimum/maximum measurement values, displaying all 3 traces.
 - **Peak Only** turns Peak Hold on displaying only Peak traces with no offset.
 - **Live+Store+Diff** selection is only available while the test is running and a Trace is loaded. The differential trace is calculated between Live and loaded stored traces during the measurement, and displayed on the graph with no offset.

- **Differential Only** selection is only available while the test is running and a Trace is loaded. Only the calculated differential is displayed on the graph.

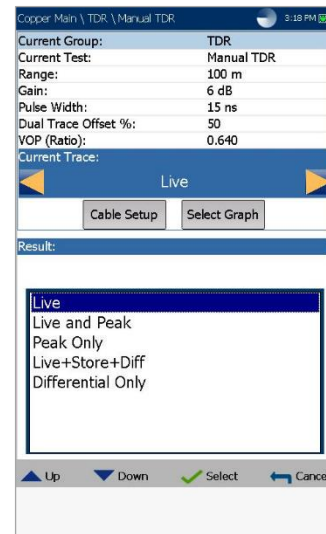



- **Cable Setup** button opens a new page that allows you to set the **Cable Parameters** for the **Current Test**.
- **Select Graph** button changes to **Graph Selected** when pressed and opens a new selection of function keys which allow you to maneuver the graph as follows:
 - **Cursor/Marker** allows you to select the cursor (blue) or marker (red) independently by toggling the function key. The footer updates to reflect either **Move cursor** or **Move marker**.
Press the left/right arrow keys to decrease/increase the values by moving the cursor/marker. Press and hold the left/right arrow keys to accelerate the cursor/marker. Press  to recall the cursor/marker and place it in the middle of the current x-axis limits.
 - **Zoom** references the middle of the x/y axis and not the cursor position. Press the arrow keys as follows:
Right = x-axis zoom in.
Left = x-axis zoom out.
Up = y-axis zoom in.
Down = y-axis zoom out.
 - **Pan** - use left/right arrow keys to pan the x-axis and the up/down arrow keys to pan the y-axis.
 - **1:1** resets the x-axis and y-axis limits to full scale.

- **Return To Test** removes these function keys and displays the previous ones.
- **Result** displays the distance to the most significant reflection, in text and graphical measurements. The distance Δ (Delta) value between cursor and marker is also displayed at the top of the graph.
- **Test Status** displays the current state of measurement or an error message.
- **Load Trace** function key opens a new page that allows you to load a trace from a list of previously saved TDR tests.
- **Clear Trace** function key deletes the loaded trace from the graph.
- **Portrait Mode** is used to change the screen orientation from landscape to portrait.
- **Select Graph** opens a new selection of function keys which allow you to maneuver the graph. (Same as above.)
- **Parameters** displays a small strip window listing the following values: **Range, Gain, Pulse Width, and Current Trace** (not in **Auto TDR**). They can be edited or viewed the same way as in Portrait Mode (described above), dependent on the TDR test being run.
- **Cable Setup** displays a small strip window when selected allowing you to change the **Cable Type, Velocity of Propagation, and Cable Temperature**. You can also view the **Cable Fill** entry which was setup in **Cable Book**. For more information, see *Cable Setup* in portrait mode.

To select the parameter values in Portrait Mode:

1. Press the up/down arrow keys to highlight the desired parameter.
2. Press the left/right arrow keys to view, select the options, or increase/decrease values.

OR

3. Press  on a value to open a list box of options or the alphanumeric editor screen and use the navigation keys to scroll through.
4. Press  to confirm the value.

Landscape Mode is the best way to use the TDR and allows you to view the test results in landscape mode utilizing the full length of the high resolution, color screen. Whether the keyboard is on the right or left is dependent on your preferred **Landscape Mode Settings** configured in **Setup/Application Settings/General**.

To select the parameter values in Landscape Mode:

1. Press the desired function key.
2. For **Parameters** and **Cable Setup**, press the up/down arrow keys to highlight the desired parameter.
3. Press the left/right arrow keys to view, select the options, or increase/decrease values.
4. Press  to confirm the value.

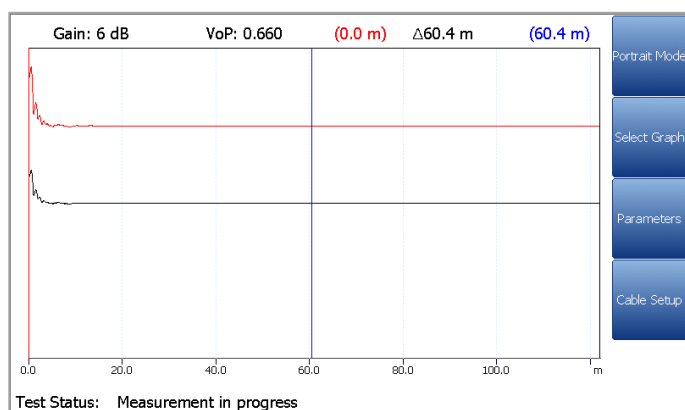

Landscape Mode generates the following function keys:

Examples of Common Faults

Short

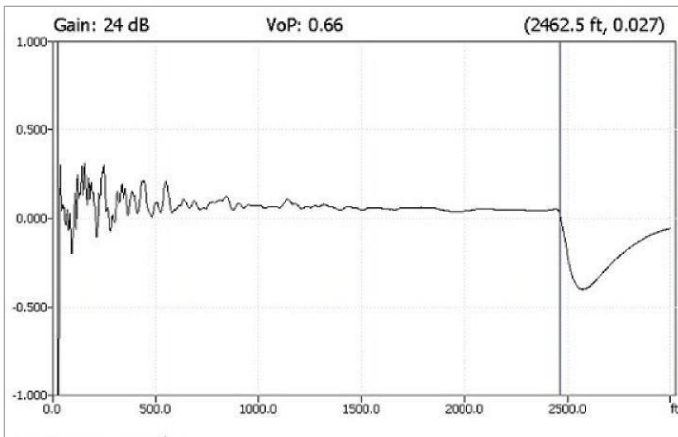

Open

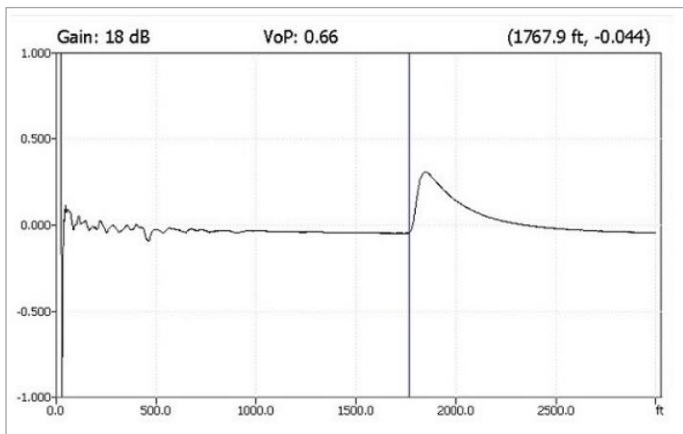

Bridged Tap

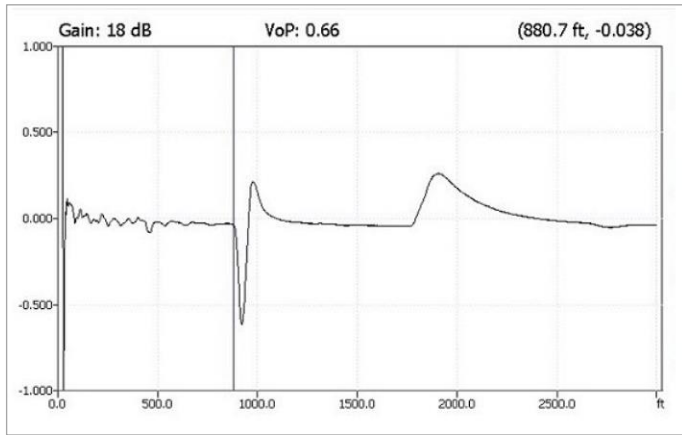

Splice Joint

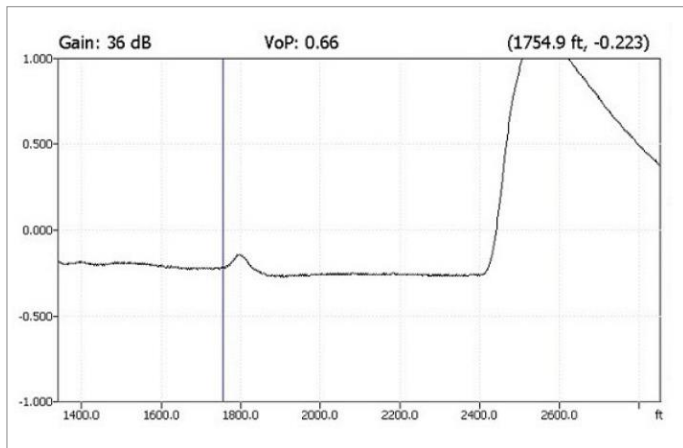

Peak Function

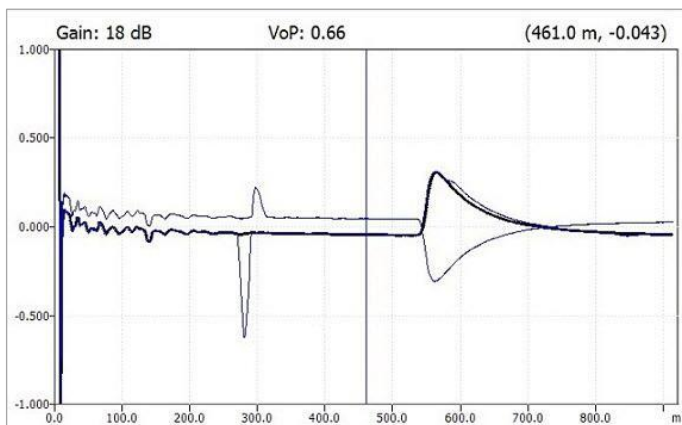

Dual Trace View

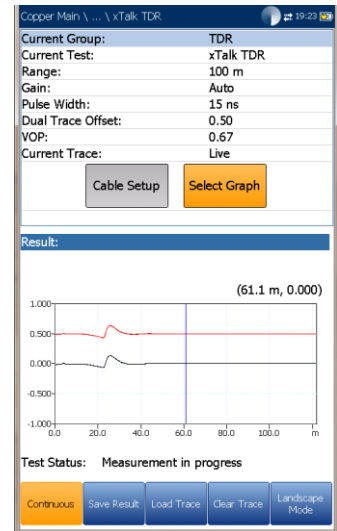
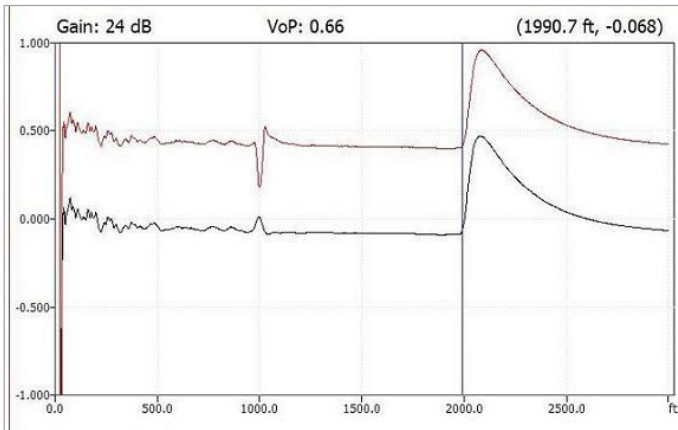

Load Coil

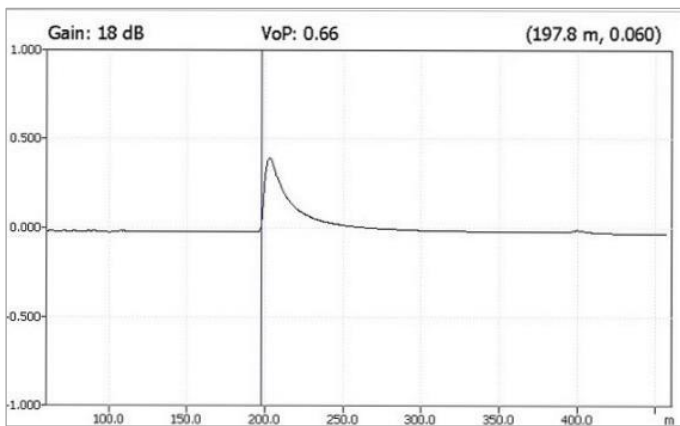

13.2 xTalk TDR

The **xTalk TDR** test transmits on one pair and receives on pair two allowing you to detect and isolate split pairs which may be causing service disruptions. The test adds a hookup diagram in the form of a **Confirmation** window at start up, showing you how to connect your cables for this test.

When FED is **Enabled** on the **FED Setup** page, both the T-R/A-B and T1-R1/A1-B1 pairs will be terminated at the FED. The hookup diagram uses graphic and textual components.

- **Proceed** button closes the hookup diagram prompt and starts the test.
- **Cancel** button closes the hookup diagram prompt only.

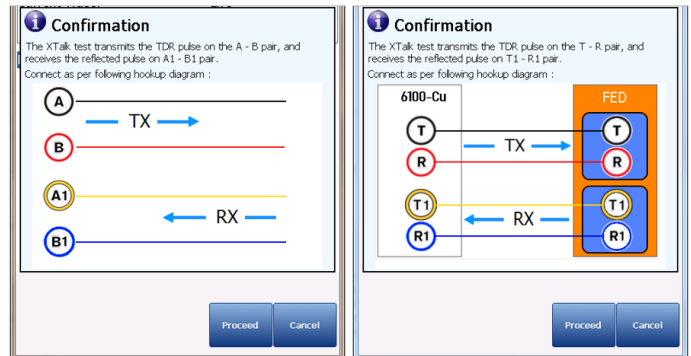

The **Continuous** function displays the line trace and is continuously on and ready to use. It displays and updates results in real time, in either **Portrait** or **Landscape Mode**, until you stop the test. The last valid results then remain displayed.

- **Current Group** displays the test being measured.
- **Current Test** allows you to select either Auto, Manual, or xTalk TDR.

*Note: The test has the same parameters as the **Manual TDR** test and does not inherit **Auto TDR** settings (**Range, Gain, Pulse Width**) when switching to the test from the **Current Test** setup line.*

- **Range** allows you to set the range from the given list.
- **Gain** allows you select the gain test parameter from the given list.
- **Pulse Width** allows you to select a value from a given list.
- **Dual Trace Offset %** is a configurable offset parameter for the secondary trace, with a range of -100 % to +100 %.

Note: If the loaded secondary trace offset = 0, then the primary and secondary traces will overlap.

- **VOP** allows you to change the velocity of propagation value for the cable.
- **Current Trace** allows you to turn on/off **Live** and **Peak** traces by selecting one of the following:
 - **Live** turns **Peak Hold OFF** clearing previously collected minimum/maximum measurement values. This is the default.
 - **Live and Peak** turns **Peak Hold ON** and collects minimum/maximum measurement values, displaying all 3 traces.
 - **Peak Only** turns **Peak Hold ON** displaying only Peak traces with no offset.
- **Cable Setup** button opens a new page that allows you to set the **Cable Parameters** for the **Current Test**.
- **Select Graph** button changes to **Graph Selected** when pressed and opens a new selection of function keys which allow you to maneuver the graph as follows:
 - **Cursor/Marker** allows you to select the cursor (blue) or marker (red) independently by toggling the function key. The footer updates to reflect either **Move cursor** or **Move marker**. Press the left/right arrow keys to decrease/increase the values by moving the cursor/marker. Press and hold the left/right arrow keys to accelerate the cursor/marker. Press  to recall the cursor/marker and place it in the middle of the current x-axis limits.
 - **Zoom** references the middle of the x/y axis and not the cursor position. Press the arrow keys as follows:
 - Right = x-axis zoom in.



Left = x-axis zoom out.

Up = y-axis zoom in.

Down = y-axis zoom out.

- **Pan** - use left/right arrow keys to pan the x-axis and the up/down arrow keys to pan the y-axis.
- **1:1** resets the x-axis and y-axis limits to full scale.
- **Return To Test** removes these function keys and displays the previous ones.
- **Result** displays the distance to the most significant reflection, in text and graphical measurements. The distance Δ (Delta) value between cursor and marker is also displayed at the top of the graph.
- **Test Status** displays the current state of measurement or an error message.
- **Load Trace** function key opens a new page that allows you to load a trace from a list of previously saved TDR tests.
- **Clear Trace** function key deletes the loaded trace from the graph.

To select the parameter values in Portrait Mode:

1. Press the up/down arrow keys to highlight the desired parameter.
2. Press the left/right arrow keys to view, select the options, or increase/decrease values.
OR
3. Press  on a value to open a list box of options or the alphanumeric editor screen and use the navigation keys to scroll through.
4. Press  to confirm the value.

- **Landscape Mode** is the best way to use the TDR and allows you to view the test results in landscape mode utilizing the full length of the high resolution, color screen. Whether the keyboard is on the right or left is dependent on your preferred **Landscape Mode Settings** configured in **Setup/Application Settings/General**.

Landscape Mode generates the following function keys:

- **Portrait Mode** is used to change the screen orientation from landscape to portrait.
- **Select Graph** opens a new selection of function keys which allow you to maneuver the graph. (Same as above.)
- **Parameters** displays a small strip window listing the following values: **Range, Gain, Pulse Width, and Current Trace**. They can be edited or viewed as described in **Portrait Mode** (above).
- **Cable Setup** displays a small strip window when selected allowing you to change the **Cable Type, Velocity of Propagation, and Cable Temperature**. You can also view the **Cable Fill** entry which was setup in **Cable Book**. For more information, see *Cable Setup* in portrait mode.

To select the parameter values in Landscape Mode:

1. Press the desired function key.
2. For **Parameters** and **Cable Setup**, press the up/down arrow keys to highlight the desired parameter.
3. Press the left/right arrow keys to view, select the options, or increase/decrease values.
4. Press ✓ to confirm the value.

13.3 Cable Setup

The **Cable Setup** page allows you to set **Cable Parameters** for the TDR test. These values can be set in **Portrait** or **Landscape Mode**.

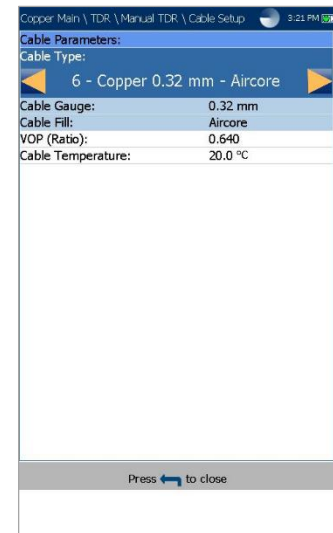

- **Cable Type** displays the ID, Cable Name and Fill, and allows you to select an entry (with its associated parameters) from the current Cable Book, to use for testing. The selection is not saved when leaving the test. The current Cable Book entry is shown by default.
- **Cable Gauge** identifies the gauge system for measuring wire sizes, in AWG (American Wire Gauge) units or mm (metric wire size).
- **Cable Fill** read-only entry is the type of material the cable is filled with: **Aircore, Jelly, Pulp, 5 PR, or 2 PR**. Setup in the **Cable Book**.
- **Velocity of Propagation** is the velocity of propagation for the cable.
- **Cable Temperature** allows you to change the temperature of the cable under test in either °F or °C.

To select the parameter values:

1. Press the up/down arrow keys to highlight the desired parameter.
2. Press the left/right arrow keys to view and select the options.
OR
3. Press ✓ on a value to open a list box of options or the alphanumeric editor screen and use the navigation keys to scroll through.
4. Press ✓ to confirm the value.

13.4 Load Trace

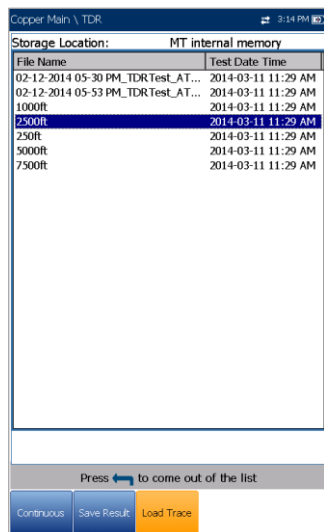

The **Load Trace** function allows you to load a saved trace. The tab opens a page listing previously saved TDR tests by **File Name** and when the test was saved, that can be used as the trace files to be loaded. A trace may be loaded:

- Prior to starting the TDR test.
- During the TDR test, while it is running.
- After the TDR test has been stopped.

Traces may be loaded from either **6100-Cu internal memory** or **USB**.

To load a previously saved trace:

1. Press the left/right arrow keys to highlight the desired Storage Location.
OR
2. Press to display the list and select the value.
3. Press the down arrow key to highlight the list box and press to open the list.
4. In the list, press the up/down arrows to select the **File Name**.
5. Press to load the trace.

13.5 Result Details

The **Results Details** page displays the TDR test result cable parameters and the last viewed **Range**, cursor, and marker positions. The distance Δ (Delta) value between cursor and marker is displayed at the top of the graph.

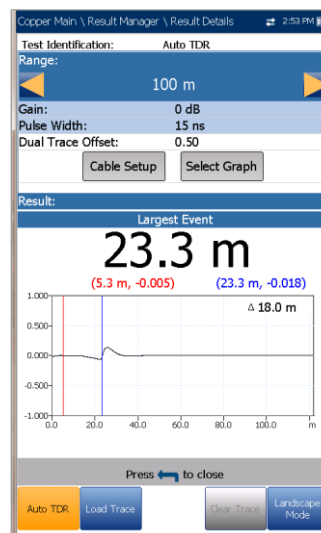

Results are shown in text and graphical format in **Portrait/Landscape Mode**. You can load a saved auto TDR trace (secondary trace) and display it simultaneously with the original TDR trace (primary trace).

Note: The saved TDR test only displays the live/primary trace.

- **Test Identification** is the test type of the group, for example Auto TDR.
- **Range** allows you to set the range from the given list in **Auto TDR** only.
- **Gain** displays whether the parameter was set to **Auto** or manual.
- **Pulse Width** is a non-editable value that is updated dependent on whether the parameters are set to **Auto** or manual.
- **Dual Trace Offset %** is a configurable offset parameter for the secondary trace, with a range of -100 % to +100 %.
- **Current Trace** (*not available in Auto TDR*) allows you to turn on/off **Live** and **Peak** traces by selecting one of the following:
 - **Live** turns **Peak Hold OFF** clearing previously collected minimum/maximum measurement values. This is the default.



- **Live and Peak** turns **Peak Hold ON** and collects minimum/maximum measurement values, displaying all 3 traces.
- **Peak Only** turns **Peak Hold ON** displaying only Peak traces with no offset.

Note: If the loaded secondary trace offset = 0, then the primary and secondary traces will overlap.

- **Cable Setup** button allows you to view the **Cable Parameters** of the **TDR** test.
- **Select Graph** button changes to **Graph Selected** when pressed and opens a new selection of function keys which allow you to maneuver the graph as follows:
 - **Cursor/Marker** allows you to select the cursor (blue) or marker (red) independently by toggling the function key. The footer updates to reflect either **Move cursor** or **Move marker**. Press the left/right arrow keys to decrease/increase the values by moving the cursor/marker.

Press and hold the left/right arrow keys to accelerate the cursor/marker. Press  to recall the cursor/marker and place it in the middle of the current x-axis limits.
 - **Zoom** references the middle of the x/y axis and not the cursor position. Press the arrow keys as follows:
Right = x-axis zoom in.
Left = x-axis zoom out.
Up = y-axis zoom in.
Down = y-axis zoom out.
 - **Pan** - use left/right arrow keys to pan the x-axis and the up/down arrow keys to pan the y-axis.
 - **1:1** resets the x-axis and y-axis limits to full scale.
 - **Return To Test** removes these function keys and displays the previous function keys.
- **Load Trace** function key opens a new page that allows you to load a trace from a list of previously saved TDR tests.
- **Clear Trace** button deletes the loaded trace from the graph.

To select the parameter values in Portrait Mode:

1. Press the up/down arrow keys to highlight the desired parameter.
2. Press the left/right arrow keys to view, select the options, or increase/decrease values.
OR
3. Press  on a value to open a list box of options or the alphanumeric editor screen and use the navigation keys to scroll through.
4. Press  to confirm the value.

- **Landscape Mode** is the best way to use the TDR and allows you to view the test results in landscape mode utilizing the full length of the high resolution, color screen. Whether the keyboard is on the right or left is dependent on your preferred **Landscape Mode Settings** configured in **Setup/Application Settings/General**.

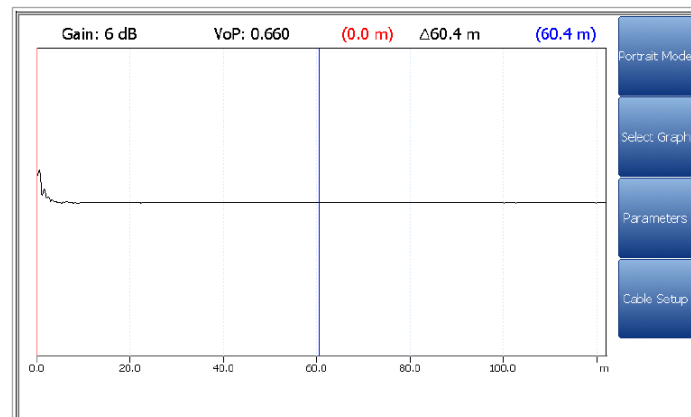

Note: The saved TDR test only displays the live/primary trace.

- **Landscape Mode** generates the following function keys:
 - **Portrait Mode** is used to change the screen orientation from landscape to portrait.
 - **Select Graph** opens a new selection of function keys which allow you to maneuver the graph. (Same as above.)
 - **Parameters** displays a small strip window listing the following values: **Range, Gain, Pulse Width and Current Trace** (not in **Auto TDR**). They can be edited or viewed the same way as in **Portrait Mode** (described above), dependent on the TDR test being run.

- **Cable Setup** displays a small strip window when selected allowing you to view the **Cable Type**, **Cable Fill**, **Velocity of Propagation**, and **Cable Temperature**. For more information, see *Cable Setup* in portrait mode.

To select the parameter values in Landscape Mode:

1. Press the desired function key.
2. For **Parameters** and **Cable Setup**, press the up/down arrow keys to highlight the desired parameter.
3. Press the left/right arrow keys to view, select the options, or increase/decrease values.
4. Press  to confirm the value.

Cable Setup

The **Cable Setup** page allows you to view the **Cable Parameters** set for the TDR test.

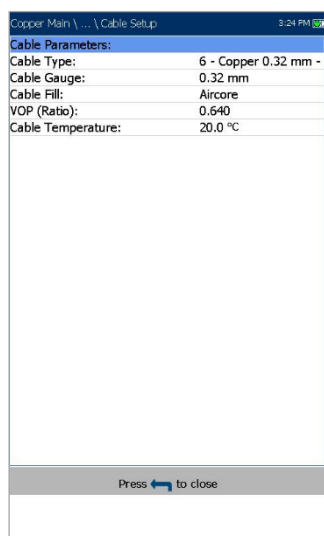

- **Cable Type** displays the ID, Cable Name and Fill, with its associated parameters from the current Cable Book.
- **Cable Gauge** identifies the gauge system for measuring wire sizes, in AWG (American Wire Gauge) units or mm (metric wire size).
- **Cable Fill** is the type of material the cable is filled with: **Aircore**, **Jelly**, **Pulp**, **5 PR**, or **2 PR**. Setup in the Cable Book.
- **Velocity of Propagation** is the velocity of propagation for the cable.
- **Cable Temperature** is the temperature of the cable under test in either °F or °C.

Load Trace

The **Load Trace** function in the Results Details is the same as previously described. Please see [Load Trace](#) on page 125 for more information.

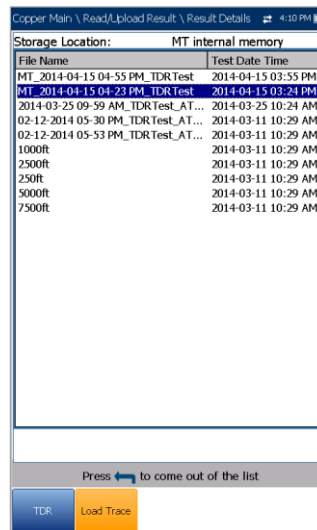

13.6 TDR Profile Details

The **Profile Details** page displays read-only TDR Test Parameters.

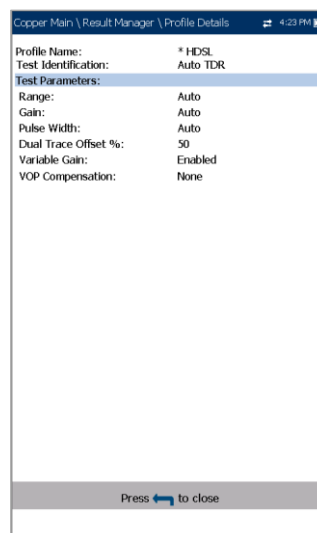

- **Profile Name** is the file name of the selected saved results.
- **Test Identification** is the test type of the group, for example **TDR**.

Section 14 RFL

Resistance fault locator (RFL) testing is a powerful means to locate resistive faults such as shorts, grounds, and battery crosses.

Before performing RFL tests, install the strap(s) at the other end of the cable. Use of an oscillator or toner as a far end strap is not recommended as it will induce errors. RFL consists of 3 tests: Single Pair, Separate Good Pair, and K upfm uller Test (K-Test).

14.1 Single Pair

The RFL **Single Pair** or 2-wire test allows you to locate resistive faults between tip and ground, or ring and ground. By default, the unit assumes that the fault cable is connected to ring.

Connect the strap to the far end of the wires connected to T/A and R/B.

- The *connection diagram* shows you how to connect the cables to the unit. The green lead is used as reference.

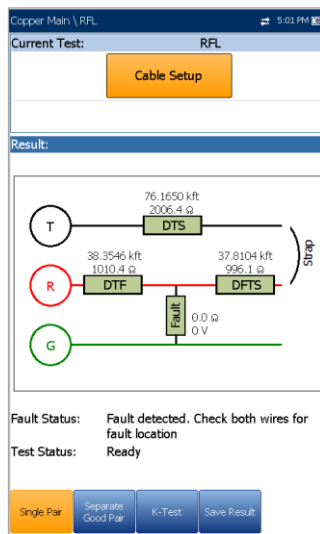

- When FED is **Enabled** on the **FED Setup** page, the **Confirmation** window pops up displaying how to connect your cables at the beginning of the test. The FED allows you to remotely place a *strap* (to short together) the T-R/A-B pair at the far end for 2-wire RFL.
- The **Confirmation** diagram uses graphic and textual components.

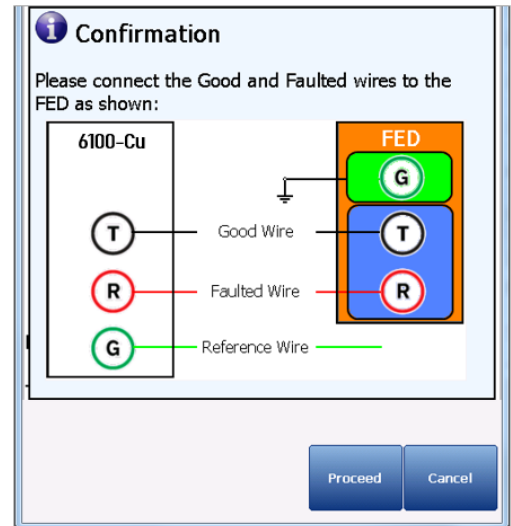

- Proceed** button closes the hookup diagram prompt and starts the test.
- Cancel** button closes the hookup diagram prompt only.

Note: Results are less accurate than a separate good pair setup.

- Current Test** displays the test being measured. When FED is **Enabled**, the FED icon and numeric state are displayed beside the **Current Test**.
- Cable Setup** button opens a new page that allows you to set the cable parameters for the **Current Test**. Press to open the page.
- Result** displays single pair RFL test results. Based on the cable condition, corresponding values are added into the diagram at their specific positions. Test result units are dependent on **Standard** in **Setup/Application Settings**.
 - Distance to strap (DTS).
 - Resistance to strap (RTS).
 - Distance from fault to strap (DFTS).
 - Resistance from fault to strap (RFTS).
 - Resistance to fault (RTF).
 - Distance to fault (DTF).
 - Faulted cable (FC).
 - Resistance at fault (Rf) is resistance from the fault to the resistance wire.
 - Voltage at fault (Vf).
- If the test reports that it cannot detect the strap when the measured loop resistance is >10 k Ohms, this may mean:

- There is no strap connected.
- There is a strap, but the cable is too long and has a loop resistance >10 k Ohms.
- There is a strap, but there is a high resistance fault or open in the cable.
- The connection (leads or strap) may be faulty.
- The resistance test may be used to troubleshoot this problem.
- **Fault Status** displays the status of the RFL test.
- **Test Status** displays the current state of measurement or an error message.

14.2 Separate Good Pair

The RFL **Separate Good Pair** or 4-wire test allows you to determine the distance to a short, ground, or battery cross on a faulty cable conductor using two separate good cable conductors.

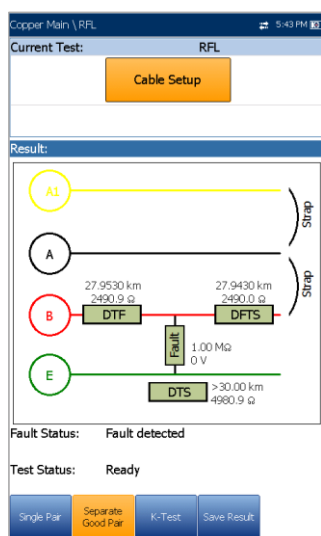

Connect a strap from the faulted wire to both conductors of the good pair.

- The *connection diagram* shows you how to connect the cables to the unit.

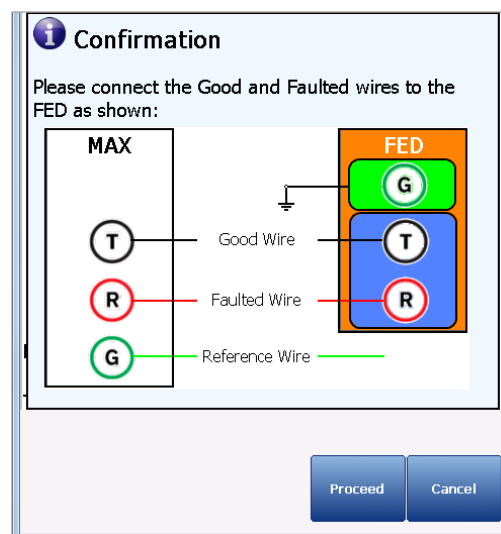

- When FED is **Enabled** on the **FED Setup** page, the **Confirmation** window pops up displaying how to connect your cables at the beginning of the test. The FED allows you to remotely place a strap (to short together) the A1/A/B (T1/T/R) at the far end for 4-wire RFL.
- The **Confirmation** diagram uses graphic and textual components.
 - **Proceed** button closes the hookup diagram prompt and starts the test.
 - **Cancel** button closes the hookup diagram prompt only.

Note: Unlike 2-wire RFL, G/E on the FED is not grounded (on the FED side).

Note: Results are more accurate but less forgiving than a 2-wire setup because the 4-wire setup requires you to connect the faulted wire conductor to the Ring (red) jack only.

- **Current Test** displays the test being measured. When FED is **Enabled**, the FED icon and numeric state are displayed beside the **Current Test**.
- **Cable Setup** button opens a new page that allows you to set the cable parameters for the **Current Test**. Press ✓ to open the page.
- **Result** displays the separate good pair RFL test results. Based on the cable condition, corresponding values are added into the

diagram at their specific positions. Test result units are dependent on **Standard** in **Setup/Application Settings**.

- Distance to strap (DTS).
- Resistance to strap (RTS).
- Distance from fault to strap (DFTS).
- Resistance from fault to strap (RFTS).
- Resistance to fault (RTF).
- Distance to fault (DTF).
- Faulted cable (FC).
- Resistance at fault (Rf) is resistance from the fault to the resistance wire.
- Voltage at fault (Vf).

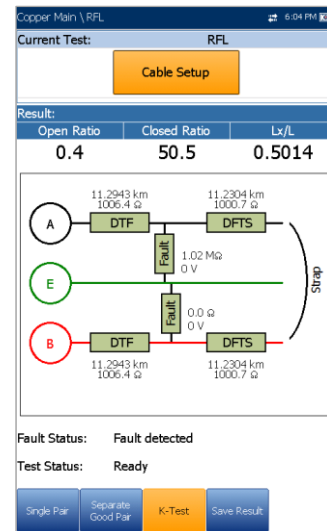

If the test reports that it cannot detect the strap when the measured loop resistance is >10 k ohms, this may mean:

- There is no strap connected.
- There is a strap, but the cable is too long and has a loop resistance >10 k Ohms.
- There is a strap, but there is a high resistance fault or open in the cable.
- The connection (leads or strap) may be faulty.

The resistance test may be used to troubleshoot this problem.

- **Fault Status** displays the status of the RFL test.
- **Test Status** displays the current state of measurement or an error message.

14.3 K-Test

The RFL **K-Test** (Küpfmüller test) method allows you to locate faults on both conductors of one pair. In other words, the K-Test is specialized for detecting double faults.

Due to the precision and sensitive nature of RFL tests, the cable pair under test should be open (disconnected) and battery removed. One of the faults must be greater in resistance than the fault on the other pair.

Note: K-Test is implemented to locate double sided faults when a good wire/pair isn't available. Both resistance faults must occur at the same place in the cable (either both to ground, or both to the same negative or positive battery voltage).

The K-Test is performed in 2 steps:

1. Measurements are made with the far end open.
 2. Measurements are made with the far end closed/shorted (strap).
- The *connection diagram* shows you how to connect the cables to the unit. The green lead is used as reference.

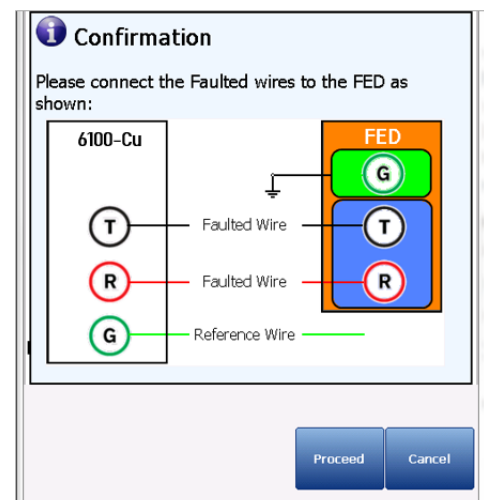

- When FED is **Enabled** on the **FED Setup** page, the **Confirmation** window pops up displaying how to connect your cables at the beginning of the test. The FED allows you to remotely place a *strap* (to short together) the T-R/A-B pair at the far end for K-Test RFL.

The **Confirmation** diagram uses graphic and textual components.

- **Proceed** button closes the hookup diagram prompt and starts the test.
- **Cancel** button closes the hookup diagram prompt only.
- **Current Test** displays the test being measured. When FED is **Enabled**, the FED icon and numeric state are displayed beside the **Current Test**.
- **Cable Setup** button opens a new page that allows you to set the cable parameters for the **Current Test**.

Press the left/right arrow key to highlight the button and press  to open the page.

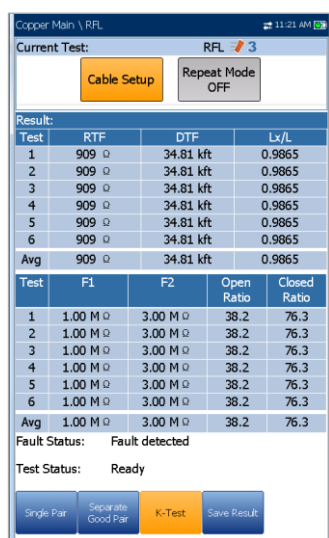

- **Repeat Mode ON/OFF** is available only when FED is **Enabled**, and can be turned **ON** to run alternating open/short tests (6 open, 5 closed) displaying average values and highlighting minimum and maximum results. When turned **OFF**, the test runs in single-shot mode only. **Repeat Mode OFF** is the default value.
- **RTF** (resistance to fault) is used as a reference to find minimum and maximum faults. When the result deviation is greater than a 20 % **Fault Status**, run the test again. If all iterations return the same values (minimum and maximum are equal), then no results are highlighted.

Press the left/right arrow key to highlight the button and press  to turn **Repeat Mode ON/OFF**.

*Note: When **Repeat Mode** is **ON**, because the test will run multiple times, it may take some time to finish.*

- **Result** displays **K-Test** results.
 - **Open Ratio** is a comparison between Fault 1 and Fault 2. The larger the fault size difference, the lower the open ratio number.
 - **Closed Ratio** is a comparison between sections. The larger the **Closed Ratio** value, the closer the fault is to the strap end.
 - **Lx/L** displays a length ratio where **Lx** = Length to fault and **L** = total Length.

Based on the cable condition, corresponding values are added into the diagram at their specific positions. Test result units are dependent on **Standard** in **Setup/Application Settings**. The **K-Test** diagram can display some of the following elements:

- R/A-T/B-G/E wire connectors.
- Distance/resistance to strap (DTS/RTS): distance/resistance from the 6100-Cu to the strap (far end).
- Distance/resistance from fault to strap (DFTS/RFTS).
- Distance/resistance to fault (DTF/RTF): distance/resistance from the 6100-Cu to the fault.

Faults are displayed as follows:

- Defective Cable (DC).
- Resistance at fault (Rf1, Rf2): resistance from the fault to the resistance wire.
- Voltage at fault (Vf1, Vf2).

If the test reports that it cannot detect the strap when the measured loop resistance is >10 k ohms, this may mean:

- There is no strap connected.
- There is a strap, but the cable is too long and has a loop resistance >10 k Ohms.
- There is a strap, but there is a high resistance fault or open in the cable.
- The connection (leads or strap) may be faulty.

The resistance test may be used to troubleshoot this problem.

- **Fault Status** displays the status of the RFL test.
- **Test Status** displays the current state of measurement or an error message.

14.4 RFL Cable Setup

The **Cable Setup** page allows you to set cable parameters for an RFL test. Settings are shared by **Single Pair, Separate Good Pair, and K-Test**. Changes done in Cable Setup for one test are reflected in all.

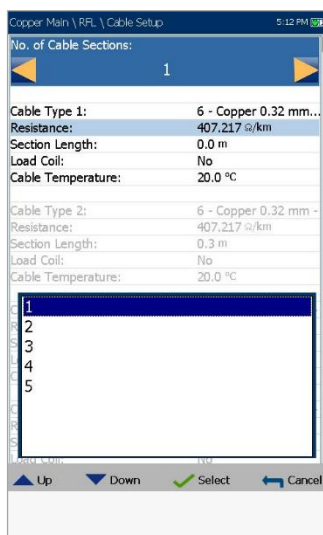

- **No. of Cable Sections** allows you to set the number of consecutive cable sections, to a maximum of 5. If unknown, set the number to 1.
- **Cable Type #** displays the number of a cable section set above, ID, Cable Name and Fill, and allows you to select an entry (with its associated parameters) from the current Cable Book, to use for testing. The selection is not saved when leaving the test. The current Cable Book entry is shown by default.
- **Resistance** specifies a value for the resistance constant of the cable in each section.
- **Section Length** allows you to specify the cable length of each section. If the cable length is unknown, specify 0 and the RFL test will measure the length.
- **Load Coil** allows you to set the detection of the presence of load coils to either **Yes** or **No**.
- **Cable Temperature** allows you to change the temperature of the cable under test in either **°F** or **°C**.

To select the parameter values:

1. Press the up/down arrow keys to highlight the desired parameter.
2. Press the left/right arrow keys to view and select the options.

OR

3. Press on a value to open a list box of options or the alphanumeric editor screen and use the navigation keys to scroll through.
4. Press to confirm the value.

14.5 Result Manager

RFL Summary

The results **Summary** page displays **Fault Status**, general and identification information, along with comments, for the test.

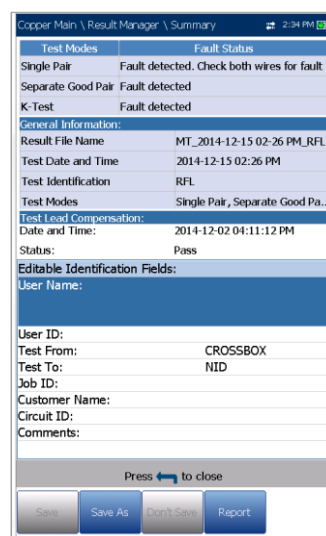

- **Test Modes** lists the RFL tests saved into the results file.
- **Fault Status** displays the status for each mode that was run.
- **General Information** displays read-only information pertaining to the test result.
 - Result File Name
 - Test Date and Time
 - Test Identification
 - Test Modes
- **Test Lead Compensation** displays read-only **Date and Time** and **Pass/Fail Status** of the compensated resistance and capacitance based on the cable temperature of the test lead.
- **Editable Identification Fields** display values from the loaded file. You can edit all fields using the editor screen or by selecting an entry from the list box.
 - User Name/ID
 - Test From/To

- Job ID
- Customer Name
- Circuit ID
- Comments
- Function keys:
 - **Save** keeps any current changes with the current file name.
 - **Save As** saves the current changes under a different file name that you can configure in the editor screen.
 - **Don't Save** does not save any changes and closes the page.
 - **Report** allows you to load a result file to a USB device, update the ID fields, and generate a report in either HTML, MHTML, or XML format.

To view and edit the test result information:

1. Press the up/down arrow keys to highlight the desired parameter.
2. Press the left/right arrow keys to view and select the options.

OR
3. Press on a value to open a list box of options or the alphanumeric editor screen and use the navigation keys to scroll through.
4. Press to confirm the value.

14.6 Result Details

Single Pair

The **Results Details** read-only page displays the **Single Pair** RFL results using text and a connection diagram.

- **Test Identification** displays the current test, for example **RFL**.
- **Cable Setup** button opens a new page displaying the cable parameters of the **RFL** test. Press to open the page.

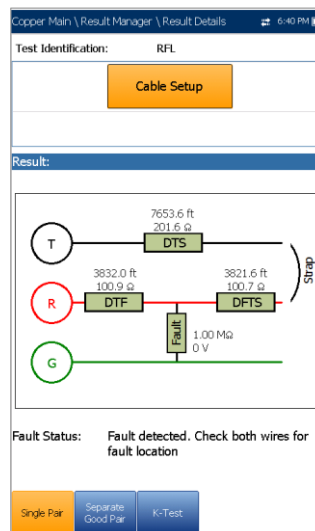

Separate Good Pair

The **Results Details** read-only page displays the **Separate Good Pair** RFL results using text and a connection diagram.

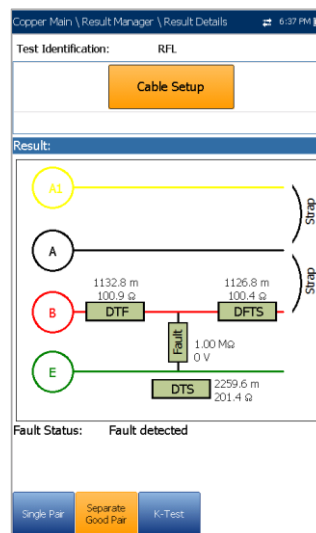

- **Test Identification** displays the current test, for example **RFL**.
- **Cable Setup** button opens a new page displaying the cable parameters of the **RFL** test. Press to open the page.

K-Test

The **Results Details** read-only page displays the **K-Test** RFL results using text and a connection diagram.

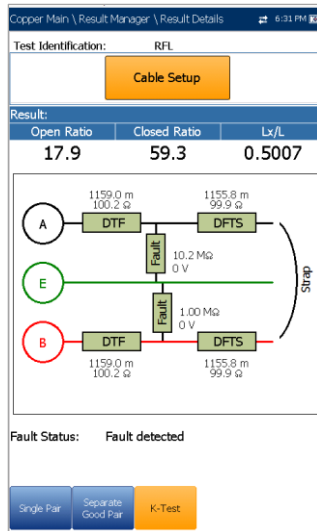

- **Test Identification** displays the current test, for example RFL.
- **Cable Setup** button opens a new page displaying the cable parameters of the RFL test. Press ✓ to open the page.

Cable Setup

The **Cable Setup** page displays the cable parameters for each section used while running the RFL test. Settings are shared by both **Single Pair** and **Separate Good Pair** tests.

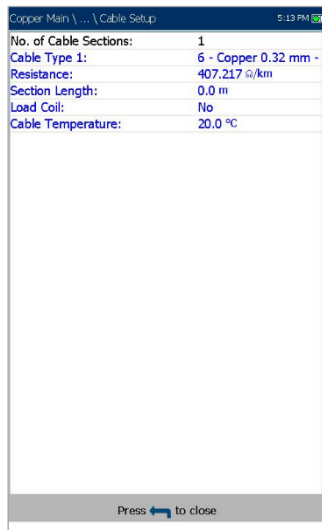

Section 15 Copper Auto Tests

15.1 Menu

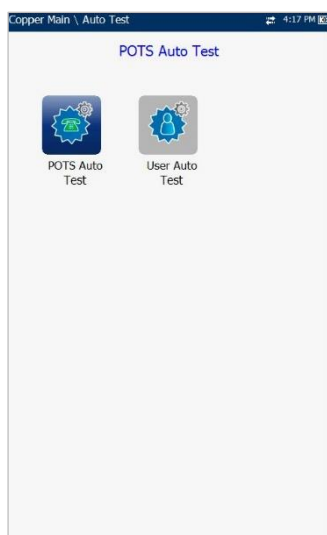

Auto Test allows you to automatically run tests used in pre-qualification, installation, and maintenance of different circuit types from POTS to VDSL2. The main menu allows you to select and run the displayed tests:

- **POTS Auto Test** detects the loop current and measures voice frequency parameters in a copper telephone loop.
- **User Auto Test** runs a range of different user-defined tests.

To activate a test:

1. Press the left/right arrow keys on the keypad to select the desired test icon.
2. Press to confirm your selection.
3. The test will start automatically if the **Setup/Application Settings - Test Startup Mode** is set to **Auto**. If not, press Start/Stop on the keypad.

15.2 POTS Auto Test

The purpose of the **POTS Auto Test** is to detect the loop current and measure the voice frequency parameters in a copper telephone loop. This test allows you to compare measured results against stored threshold values to provide pass or fail status results of the POTS circuit type.

To access POTS Auto Test:

1. From the **Copper Main** menu, use the up/down, left/right arrow keys to highlight **Auto Test** and press .
2. Highlight **POTS Auto Test** and press to start the test.

Summary

The **Summary** page displays detailed results of the loop current, Power Influence and voice frequency measurement values, pass/fail status, and parameters. POTS Auto Test consists of a combination of multiple tests.

Result:		
Dial Information	Global P/F	
Number:	4169981110	
Status:	Silence Detected	
Test	Value	P/F
Loop DC Current (T - R):	32.3 mA	
Loss (T - R):	-0.6 dB	
Power Influence:	-69.7 dBm	
VF Noise:	-68.9 dBm	
VF Balance (Active):	76.6 dB	
Test Status: Ready		

- **Current Group** is the current test group name, for example **Auto Test**.
- **Current Test** displays the test being measured. Here you can switch to another test from the given list. However, this action will terminate the ongoing measurement test.
- **VF Noise Filter** displays the voice frequency noise filter used, dependent on **ITU** or **ANSI Standard** mode and the Noise Filter set in **Setup/Application Settings**.

- Phone Book Parameters:
 - **Phone Book Group** allows you to select the **Group #** from a list of phone book groups that include mW tone entries.
 - **Milliwatt Tone Entry** displays at least 1 mW tone entry number from the selected **Phone Book Group**.
 - **Quiet Line Entry** displays the quiet line entry number from the selected **Phone Book Group**.

The dialer will contact the above 2 phone numbers at specific points of time while the test is running.

- **Volume** button adjusts the volume level.
- **Threshold Settings** button opens a new page that allows you to set the **POTS Auto Test** threshold parameters.
- **Mute/Unmute Speaker** button changes the speaker status.
- **Result** displays the number dialed and its status, measurement values of the multiple test parameters and their pass/fail status.
- **Test Status** displays the current state of measurement or an error message.

To select the parameter values:

1. Press the up/down arrow keys to highlight the desired parameter.
 2. Press the left/right arrow keys to view and select the options.
- OR
3. Press ✓ on a value to open a list box of options.
 4. Press ✓ to confirm the value.

POTS Auto Test Threshold Settings

The **Threshold Settings** page allows you to set the **POTS Auto Test Threshold Settings** for the combination of multiple tests. The threshold values do not come from individual tests but are unique to POTS.

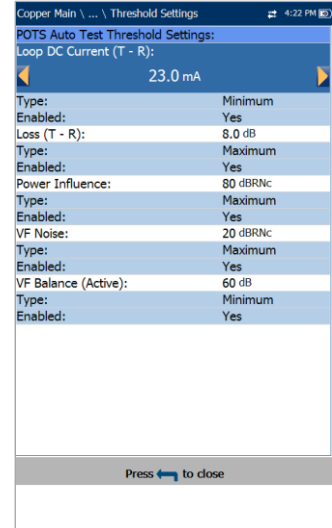

- **Loop DC Current** sets the DC current value for the wire pair.
- **Loss** sets the loss value for the wire pair.
- **Power Influence** sets the power influence value for the test.
- **VF Noise** sets the level of voice frequency noise to be used.
- **VF/AC Balance (Active)** sets the VF/AC longitudinal balance value for active mode.
- **Type** is a read-only field displaying the threshold limit: either **Minimum** or **Maximum**.
- **Enabled** is a read-only field and always **Yes** for all thresholds.

To set threshold values:

1. Press the up/down arrow keys to highlight the desired parameter.
 2. Press ✓ on a value to open the alphanumeric editor screen and use the navigation keys to scroll through.
- OR
3. Press ✓ to select each value and use the function keys to complete your selection.
 4. Press ← to confirm and close your selections.

Result Details

The **Results Details** read-only page displays the number dialed and its status, measurement values of the test parameters and their pass/fail status.

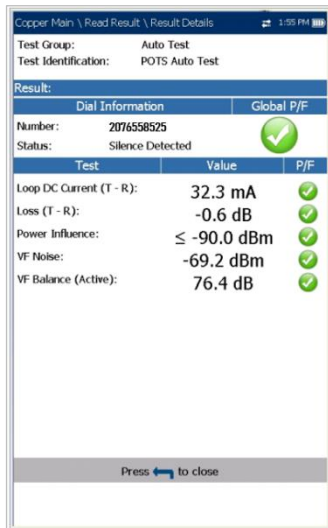

Phone Book

The **Phone Book** results page displays the **Group #** and type entry parameters when loading the results file.

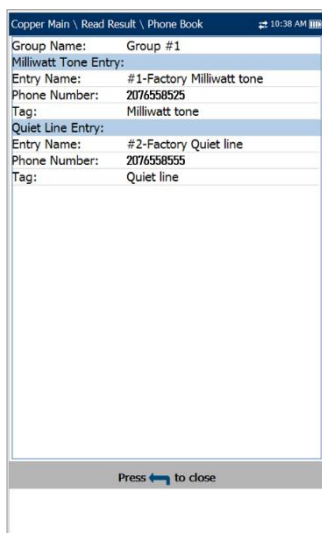

15.3 User Auto Test

User Auto Test runs a range of different user-defined tests that compare measured results against stored threshold values to provide pass or fail status and results. Test parameters and thresholds are inherited from individual tests.

To access User Auto Test:

1. From the **Copper Main** menu, use the up/down, left/right arrow keys to highlight Auto Test and press ✓.
2. Highlight User Auto Test and press ✓ to start the test.

Summary

The **Summary** page displays the overall pass/fail status of all tests selected for auto testing.

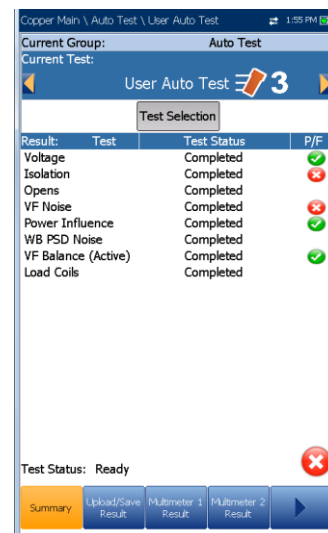



- **Current Group** is the current test group name, for example **Auto Test**.
- **Current Test** displays the test being measured. Here you can switch to another test from the given list. However, this action will terminate the ongoing measurement test.
- When FED is **Enabled**, the FED icon and numeric state are displayed beside the **Current Test**.
- **Test Selection** button opens a new page that allows you to select the tests to include in the **User Auto Test**.
- **Result** displays each test selected and its status.
- **Test Status** displays the current state of measurement or an error message.

To select the parameter values:

1. Press the up/down arrow keys to highlight the desired parameter.
2. Press the left/right arrow keys to view and select the options.

OR

3. Press  on a value to open a list box of options.
4. Press  to confirm the value.

Test Selection

The **Test Selection** page allows you to select the test types to include in the auto test, and set a **Pause** between tests by selecting **ON** or **OFF**. When **FED** is **Enabled** on the **FED Setup** page, **Pause** is replaced with **FED State** parameters. All listed tests have a fixed duration (snapshot) and are not continuous. Graphs are not displayed.

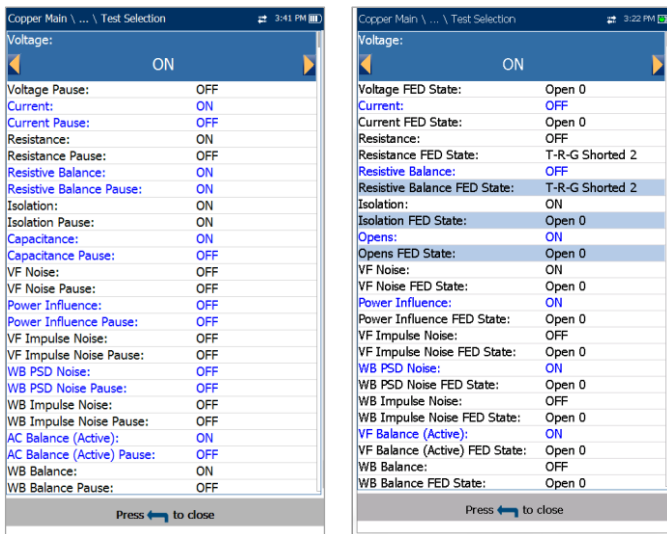

The following tests are available:

- **Voltage** detects AC RMS and DC voltages in the line.
- **Current** checks for AC RMS and DC currents in the line.
- **Resistance** uses DC current to measure the opposition to flow, or resistance, between each of the lead combinations. It is also used to identify possible faults, and to measure the resistance of the twisted pair cable for estimating loop length.
- **Resistive Balance** measures and compares the resistance of each leg.
- **Isolation** measures the quality of insulation or sheathing for the copper pairs.

- **Capacitance/Opens** measures the capacitance of the cable for estimating loop length.
- **VF Noise** measures voice frequency noise in the line.
- **Power Influence** measures the effects that 50 Hz and 60 Hz power line (AC Mains) interference has on the circuit under test.
- **VF Impulse Noise** measures the random occurrences of energy spikes in the voice frequency range that have random amplitude and spectral content.
- **WB PSD Noise** measures power spectral density noise.
- **WB Impulse Noise** measures the irregular occurrences of energy spikes in the wideband range that have random amplitude and spectral content.
- **VF/AC Balance (Active)** is very useful in identifying loops that will suffer from crosstalk.
- **WB Balance** ensures that the balance ratio for the twisted pair complies with applicable standards so as to reduce the effects of common-mode voltage to ground.
- **WB Attenuation** measures the dissipation of power of a transmitted signal as it travels over the copper line.
- **Load Coils** detects the presence of load coils in the line.
- **TDR** characterizes and locates faults in cables under test.
- **DRP** (Data Rate Prediction) is a software option. When enabled, the prediction calculation is based on the PSD noise and wideband (WB) attenuation measurement results up to 35 MHz. Ensure **WB Attenuation** and **WB PSD Noise** tests are selected for **DRP** to function. It is recommended to run the **DRP** test on open lines only (non-terminated). For FED support, the FED state for both **WB Attenuation** and **WB PSD Noise** must be set to **Open 0**.
- **Return Loss** measures the loss of power in the **Sweep** frequency returned/reflected by a discontinuity in a transmission line.

To select the tests:

1. Press the up/down arrow keys to scroll through all the tests and highlight the desired parameter.
2. Press the left/right arrow keys to view and select the options.

OR

3. Press ✓ on a value to open a list box of options.
4. Press ✓ to confirm the value.
5. Press ↩ to confirm and close your selections.

Upload/Save Result

The **Upload/Save Result** tab allows you to save/upload/export **Auto Test** results, using the upload method (Wi-Fi, or Ethernet) previously selected in **System Settings/Upload Setup**.

The tab displays a screen where the following information can be entered and functions performed:

- Identification Fields
 - **User Name/User ID** display the values set up in the Application Settings/Identification tab. You can edit this field using the editor screen.
 - **Contractor Name** allows you to enter the name of a contractor used to perform the tests.
 - **Test From/To** display the values set up in the **Application Settings/Identification** tab. You can edit this field using the choices from the list box.
 - **Job ID** allows you to create/edit a unique identifier for the task.
 - **Customer Name** is the name of the customer for which the test was run.



- **Circuit ID** allows you to create/edit a unique identifier for the circuit under test.
- **Comments** allow you to add any relevant information.
- Save Result
 - **Select Result File** button displays a list of existing file names where you can save your results.
 - **Result File Storage Location** gives you the option of storing results either in the 6100-Cu internal memory or USB device. The default selection comes from Application Settings/General tab.
 - **Result File Name** previews the result file name which consists of the **Circuit ID**, date and time as configured in **System Settings/Date and Time**, and version number if there are multiple versions with the same filename.
 - **Upload & Save** button initializes the result file upload and confirms if the **Upload File Name** is saved successfully.
 - **Save** button confirms if the **Result File Name** is saved successfully.
- Export Report
 - **Report File Storage Location** is set to USB automatically.
 - Report Format is HTML, MHTML, or XML.

You can generate and export HTML, MHTML, or XML reports from any saved test result.

Reports include:



- **General Information** including **Pass/Fail** status.
- **Identification**
- **Profile/Result Summary**
- Blank entries for your **Signature** and the **Date**.
- **Report File Name** previews the result file name which consists of the **Circuit ID**, date and time as configured in **System Settings/Date and Time**, and version number if there are multiple versions with the same filename.
- **Export** button confirms if the **Report File Name** is saved successfully. If a USB device is not inserted, the following warning dialogue box appears: **USB device not present**.

To set parameter values and save results:

1. Press the left/right and up/down arrow keys to highlight the desired parameter.
2. Press  to display the list or select the value.
3. Press the up/down arrow key to highlight the desired value.
OR
4. Press the left arrow key to erase the existing value, and then use the alphanumeric keypad to enter a value. To cancel the entry, press .
5. Press  to accept the value.

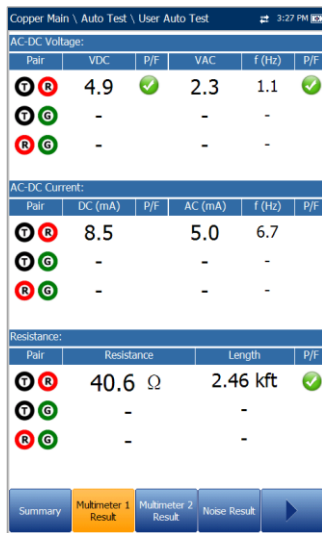
Multimeter 1 Result



AC-DC Voltage:						
Pair	VDC	P/F	VAC	f (Hz)	P/F	
T/R	4.9		2.3	1.1		
T/G	-		-	-		
R/G	-		-	-		

AC-DC Current:						
Pair	DC (mA)	P/F	AC (mA)	f (Hz)	P/F	
T/R	8.5		5.0	6.7		
T/G	-		-	-		
R/G	-		-	-		

Resistance:				
Pair	Resistance	Length	P/F	
T/R	40.6 Ω	2.46 kft		
T/G	-	-		
R/G	-	-		

The **Multimeter 1 Result** page displays the following results and pass/fail status:

- **AC-DC Voltage** - volts and frequency (Hz) values for each continuous AC/DC Pair.
- **AC-DC Current** - DC current, AC current and frequency (Hz) values for each wire Pair.
- **Resistance** for each wire Pair and Length for T/R/A/B.

Multimeter 2 Result

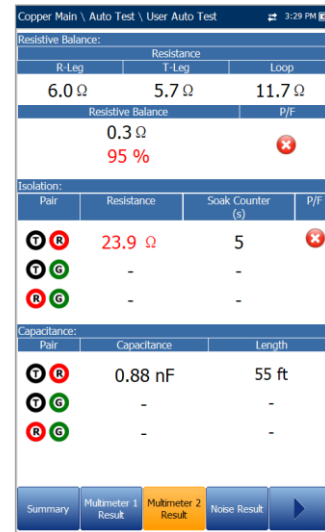

Resistive Balance:			
R-Leg	T-Leg	Loop	P/F
6.0 Ω	5.7 Ω	11.7 Ω	
Resistive Balance		0.3 Ω	
		95 %	

Isolation:			
Pair	Resistance	Soak Counter (s)	P/F
T/R	23.9 Ω	5	
T/G	-	-	
R/G	-	-	

Capacitance:		
Pair	Capacitance	Length
T/R	0.88 nF	55 ft
T/G	-	-
R/G	-	-

The **Multimeter 2 Result** page displays the following results and pass/fail status:

- **Resistive Balance - R/B-Leg, T/A-Leg, Loop** resistance, and pass/fail status and values in Ω and %.
- **Isolation** - pass/fail status, **Resistance** and a **Soak Counter(s)** for each wire Pair. If your unit has the HIVOLT (high voltage) software option configured, it enables **Isolation Resistance** testing up to 500 V. Default is inherited from **Multimeter Isolation** test.
- Capacitance/Opens and Length for each wire Pair and overall Capacitive Balance.

Noise Result

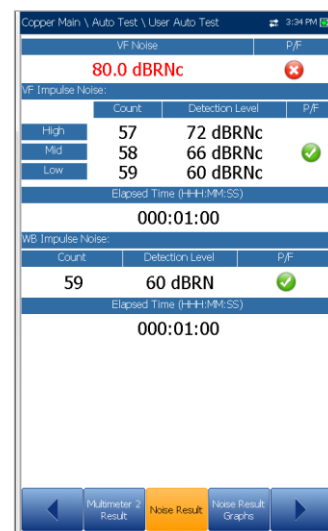

VF Noise		P/F
80.0 dBRnc		

VF Impulse Noise:			
	Count	Detection Level	P/F
High	57	72 dBRnc	
Mid	58	66 dBRnc	
Low	59	60 dBRnc	

Elapsed Time (HH:MM:SS)

000:01:00

WB Impulse Noise:		
Count	Detection Level	P/F
59	60 dBRN	

Elapsed Time (HH:MM:SS)

000:01:00

The **Noise Result** page displays the following results and pass/fail status:

- **VF Noise** measures voice frequency noise in the line.
- **VF Impulse Noise - High, Mid, Low** counts, respective detection levels, and **Elapsed Time**. Here the pass/fail status is for the **Mid**-level only.
- **WB Impulse Noise** - impulse Count, Detection Level, and Elapsed Time.

Noise Result Graph

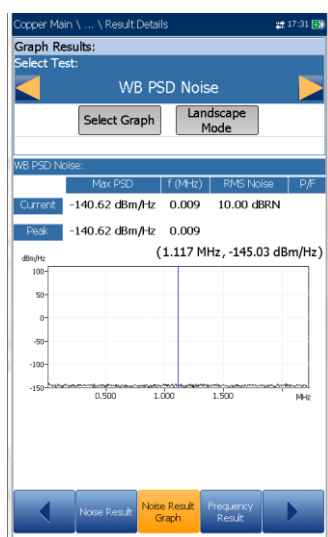

The **Noise Result Graph** page displays the pass/fail status and results in graphical format for the following noise tests:

- **Power Influence** measures the effects that 50 Hz and 60 Hz powerline (AC Mains) interference has on the circuit under test.
- **WB PSD Noise** - **Max PSD** and frequency and **RMS Noise** values differentiating the **Current** trace from the **Peak** hold. This test can be viewed in **Landscape Mode**.

To select a test:

1. In the **Select Test** parameter, press the left/right arrow keys to view and select the options.
OR
2. Press **✓** on a value to open a list box of options and press the up/down arrow keys to highlight the desired test.

3. Press **✓** to confirm the test.

- **Select Graph** button changes to **Graph Selected** when pressed and opens a new selection of function keys which allow you to maneuver the graph as follows:
 - **Cursor** - press the left/right arrow keys to decrease/increase the values by moving the cursor. Press and hold the left/right arrow keys to accelerate the cursor. Press **✓** to recall the cursor and place it in the middle of the current x-axis limits.
 - **Zoom** references the middle of the x/y axis and *not* the cursor position. Press the arrow keys as follows:
 - Right = x-axis zoom in.
 - Left = x-axis zoom out.
 - Up = y-axis zoom in.
 - Down = y-axis zoom out.
 - **Pan** - use left/right arrow keys to pan the x-axis and the up/down arrow keys to pan the y-axis.
 - **1:1** resets the x-axis and y-axis limits to full scale.
 - **Return To Test** removes these function keys to display the previous function keys.
- **Landscape Mode** function key allows you to view the **WB PSD Noise** results in landscape mode. Whether the keyboard is on the right or left is dependent on your preferred **Landscape Mode Settings** configured in **Application Settings/General**.

Frequency Result

The **Frequency Result** page displays results and pass/fail status for the **VF/AC Balance** test.

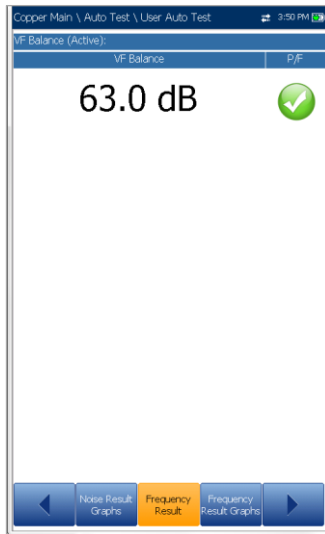

Frequency Result Graphs

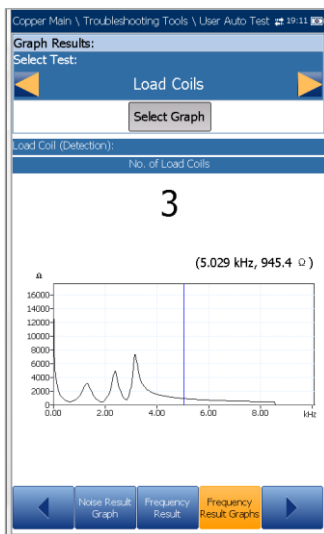



The **Frequency Result Graphs** page displays the results in text and graphical format for the following frequency tests:

- **WB Balance** displays pass/fail status, and mask if the last selected threshold parameter was set to **Mask**.
- **WB Attenuation** displays pass/fail status, mask if the last selected threshold parameter was set to **Mask**, and values for:
 - **Cable Length**
 - **Elapsed Time (M:SS)**

- **Load Coil (Detection)** displays the number of load coils.
- **Return Loss** displays the pass/fail status and a graph of the **Return Loss Sweep** compared to **Marginal** results. If the measurement is greater/less than the marginal test threshold, represented by a horizontal red line, the status is fail. Otherwise, the status is pass.

To select a test:

1. In the **Select Test** parameter, press the left/right arrow keys to view and select the options.
OR
 2. Press  on a value to open a list box of options and press the up/down arrow keys to highlight the desired test.
 3. Press  to confirm the test.
- **Select Graph** button changes to **Graph Selected** when pressed and opens a new selection of function keys which allow you to maneuver the graph as follows:
 - **Cursor** - press the left/right arrow keys to decrease/increase the values by moving the cursor. Press and hold the left/right arrow keys to accelerate the cursor. Press  to recall the cursor and place it in the middle of the current x-axis limits.
 - **Zoom** references the middle of the x/y axis and not the cursor position. Press the arrow keys as follows:
 - Right = x-axis zoom in.
 - Left = x-axis zoom out.
 - Up = y-axis zoom in.
 - Down = y-axis zoom out.
 - **Pan** - use left/right arrow keys to pan the x-axis and the up/down arrow keys to pan the y-axis.
 - **1:1** resets the x-axis and y-axis limits to full scale.
 - **Return To Test** removes these function keys to display the previous function keys.

TDR Result

The TDR Result page displays the TDR test result cable parameters and the distance to the most significant reflection or Largest Event, in text and graphical format in either Portrait or Landscape Mode. The distance Δ (Delta) value between cursor and marker is displayed on the top of the graph.

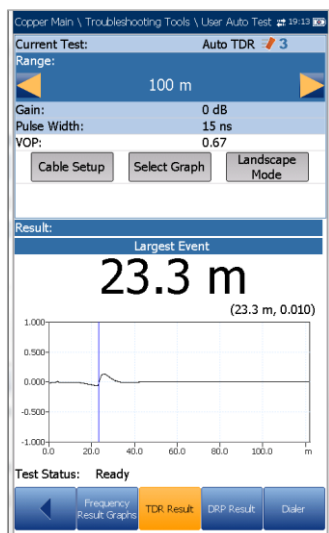

- **Current Test** displays the test being measured, for example **Auto TDR**.
- **Range** allows you to set the range from the given list.
- **Gain** is a non-editable value that is updated dependent on whether the **Range** was set to **Auto** or a manual value.
- **Pulse Width** is a non-editable value that is updated dependent on the **Range**.
- **VOP** allows you to change the velocity of propagation value for the cable.
- **Cable Setup** button allows you to view the **Cable Parameters** of the TDR test.
- **Select Graph** button changes to **Graph Selected** when pressed and opens a new selection of function keys which allow you to maneuver the graph as follows:
 - **Cursor/Marker** allows you to select the cursor (blue) or marker (red) independently by toggling the function key. The footer updates to reflect either **Move cursor** or **Move marker**. Press the left/right arrow keys to decrease/increase the values by moving the cursor/marker. Press and hold the left/right arrow keys to accelerate the cursor/marker. Press to recall the

cursor/marker and place it in the middle of the current x-axis limits

- **Zoom** references the middle of the x/y axis and not the cursor position. Press the arrow keys as follows:
 - Right = x-axis zoom in.
 - Left = x-axis zoom out.
 - Up = y-axis zoom in.
 - Down = y-axis zoom out.
- **Pan** - use left/right arrow keys to pan the x-axis and the up/down arrow keys to pan the y-axis.
- **1:1** resets the x-axis and y-axis limits to full scale.
- **Return To Test** removes these function keys and displays the previous function keys.
- **Landscape Mode** button allows you to configure and view the parameters and test results in landscape mode. Whether the keyboard is on the right or left is dependent on your preferred **Landscape Mode Settings** configured in **Application Settings/General**.

TDR Result Cable Setup

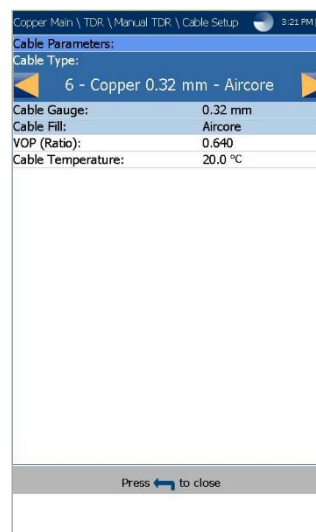

The **Cable Setup** page allows you to configure and/or view the **Cable Parameters** set for the TDR test.

- **Cable Type** displays the ID, Cable Name and Fill, and allows you to select an entry (with its associated parameters) from the current Cable Book, to use for testing. The selection is not saved when leaving the test. The current Cable Book entry is shown by default.

- **Cable Gauge** identifies the gauge system for measuring wire sizes, in AWG (American Wire Gauge) units or mm (metric wire size).
- **Cable Fill** displays the type of material the cable is filled with: **Aircore**, **Jelly**, **Pulp**, **5 PR**, or **2 PR**. Setup in the **Cable Book**.
- **Velocity of Propagation** is the velocity of propagation for the cable.
- **Cable Temperature** is the temperature of the cable under test in either °F or °C.
- **Recalculate** button allows you to recalculate data rates after editing the following Test Parameters:
 - **SNR Margin** is the signal-to-noise ratio margin measured on the line.
 - **Bits/Bin** allows you to select the ADSL bandwidth bit rate.
 - **Technology** allows you to select a frequency band from a list of possible technologies (subject to the **Software Options** enabled).

DRP Result

The **Data Rate Prediction (DRP)** is a software option and requires that **WB Attenuation** and **WB PSD Noise** tests are selected to enable the **DRP** test. When enabled, the page displays the predicted maximum **Downstream** and **Upstream** data rates.

Data Rate Prediction (DRP)	
Direction	Maximum Rate
Downstream:	179.8 Mbps
Upstream:	69.68 Mbps

Recalculate

Test Parameters:	
SNR Margin (Downstream):	7 dB
SNR Margin (Upstream):	10 dB
Bits/Bin:	15
Technology:	VDSL2_998ADE35-M...
Reference Point (side):	CO

Information	
Annex	B
Remote Noise Level	-110 dBm/Hz

Navigation buttons: Frequency Result Graphs, TDR Result, **DRP Result**, Diagnostics

If a calculation is not possible, the calculated bandwidth data is replaced by a message. It states that the **DRP** cannot be completed due to low bandwidth settings in the **Noise PSD** and/or **Attenuation** tests; and that with the current settings, you can calculate rates up to a certain *highest possible* **Technology**, listed as follows.

- If the **Noise PSD** and/or **Attenuation** bandwidth are:
 - < 1.1 MHz then no **Technology** applies.
 - 1.1 MHz then **ADSL** or **ADSL2**.
 - 2.2 MHz, 8 MHz, or 12 MHz then **ADSL**, **ADSL2**, or **ADSL2+**.
 - 17 MHz or 30 MHz then **ADSL**, **ADSL2**, **ADSL2+**, or **VDSL2-17a**.
 - 35 MHz then all technologies apply.

Note: VDSL2-35b requires the VDSL2-35b Data Rate Prediction software option and CQ Board Revision J or higher.

- **Reference Point (side)** is either **CO** (default) or **CPE**. Set this value based on where you connect the tester: for example, if the tester is connected at the user side and performs a test toward the **CO**, set the **Reference Point** to **CPE**.
- Information
 - **Annex** displays the mode: **A** or **B**.
 - **Remote Noise Level** ranges from -40 to -110 dBm/Hz (default) and is configurable in profile *.cqcfg files. The noise level value is dependent on the **Reference Point**.

To recalculate the **DRP**:

1. Press the up/down arrow keys to highlight the desired parameter.
2. Press the left/right arrow keys to increase/decrease the values.
OR
3. Press ✓ on a value to open a list box of options or the alphanumeric editor screen and use the navigation keys to scroll through.
4. Press ✓ to confirm the value.
5. Press the up button to select the **Recalculate** button.

15.4 Result Details

The **Result Details** for **User Auto Test** display all the saved results presented during the test.

Please see

[Multimeter 1 Result](#) on page 141,
[Multimeter 2 Result](#) on page 141,
[Noise Result](#) on page 141,
[Noise Result Graph](#) on page 142, and
[Frequency Result](#) on page 143

for more information.

Summary

The **Result Details Summary** page displays the overall pass/fail status of all tests selected for auto testing. This page varies slightly from the run **User Auto Test** page in that there are no configurable parameters.

Result:	Test	Test Status	P/F
	Voltage	Completed	✓
	Current	Completed	✓
	Resistance	Completed	✓
	Resistive Balance	Completed	✓
	Isolation	Completed	✗
	Opens	Completed	✗
	VF Noise	Completed	✗
	Power Influence	Completed	✓
	VF Impulse Noise	Completed	✓
	WB PSD Noise	Completed	✓
	WB Impulse Noise	Completed	✓
	VF Balance (Active)	Completed	✓
	WB Balance	Completed	✗
Global P/F:			✗

- **Test Group** is the overall test group of the selected saved results file, for example **Auto Test**.
- **Test Identification** is the test type of the group, for example **User Auto Test**.
- **Cable Setup** button opens a new page that allows you to view the parameters of the cable used in the Auto Test. Press ✓ to open the page.

Cable Setup

The Cable Setup page displays read-only parameters of the cable used in the Auto Test.

Cable Parameters:	
Cable Type:	6 - Copper 0.32 mm -
Cable Gauge:	0.32 mm
Cable Fill:	Aircore
VOP (Ratio):	0.640
Cable Temperature:	21.1 °C

- **Cable Type** displays the ID, Cable Name and Fill, (with its associated parameters) from the current Cable Book, used for testing.
- **Cable Fill Material** is the type of material the cable is filled with: **Aircore, Jelly, Pulp, 5 PR, or 2 PR**.
- **Velocity of Propagation** is the velocity of propagation for the cable.
- **Cable Temperature** is the temperature of the cable under test in either °F or °C.

15.5 Profile Details

Profile Details contains the details of the **Test Selection** settings for **User Auto Test**. If FED is **Enabled** on **FED Setup** page, **Pause** is replaced by **FED States** parameters and will show the FED state for each test.

- **Test Parameters** button opens a new page displaying read-only parameter details of all tests.
- **Test Thresholds** button opens new pages displaying read-only threshold values for all tests.

- FED displays **Enabled** or **Disabled**.



Noise 1 Parameter

The **Noise 1 Parameter** page displays the profile details of the parameter values for the **VF Noise**, **Power Influence**, and **VF Impulse Noise** tests.

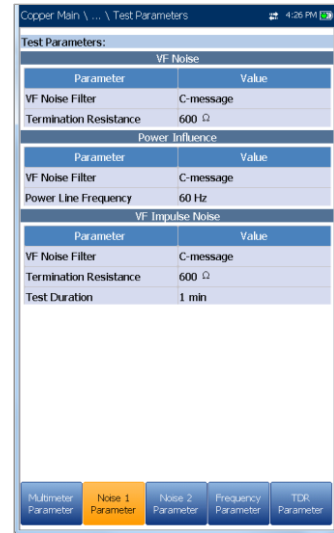

To access the test parameter and threshold results:

- Press the left/right arrow keys to highlight a button.
- Press to open the page.

Test Parameters

The Test Parameters page displays read-only parameter details of all tests.

Multimeter Parameter

The **Multimeter Parameters** page displays the profile details of the cable parameters for all multimeter tests.

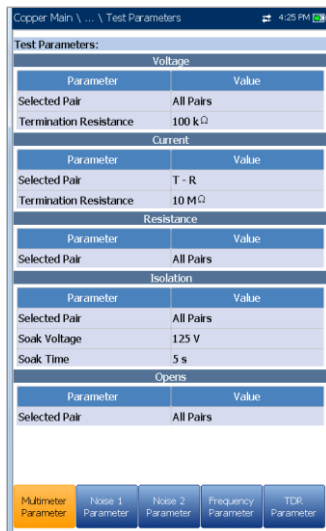

Noise 2 Parameter

The **Noise 2 Parameter** page displays the profile details of the parameter values for the **WB PSD/Impulse Noise** tests.

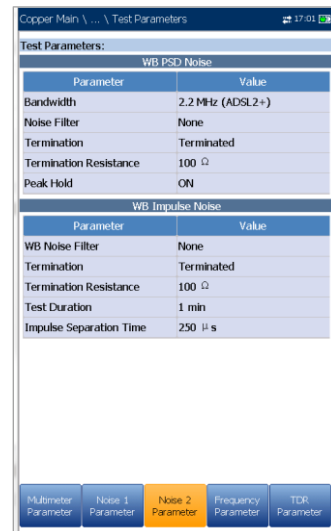

Frequency Parameter

The **Frequency Parameters** page displays the profile details of the parameter values for the **WB Balance/Attenuation, DRP, and Return Loss tests.**

Test Parameters:	
WB Balance	
Parameter	Value
Bandwidth	2.2 MHz (ADSL2+)
Termination Resistance	100 Ω
WB Attenuation	
Parameter	Value
Bandwidth	2.2 MHz (ADSL2+)
Mask Tolerance	2
Data Rate Prediction (DRP)	
Parameter	Value
SNR Margin	6 dB
Bits/Bin	15
Item	Value
Technology	ADSL2+
Annex	A
Reference Point (side)	CO
Remote Noise Level	-110 dBm/Hz
Return Loss	
Parameter	Value
Bandwidth	2.2 MHz (ADSL2+)
Termination Resistance	100 Ω

Multimeter 1 Threshold

The **Multimeter 1 Threshold** page displays the **AC/DC Voltage** and **Current Test Thresholds** and limits for each **Pair**.

Test Thresholds - Voltage:			
AC Voltage			
Pair	Voltage	Type	Enabled
T - R	30.0 VAC	Maximum	Yes
T - G	30.0 VAC	Maximum	Yes
R - G	30.0 VAC	Maximum	Yes
DC Voltage			
Pair	Voltage	Type	Enabled
T - R	500.0 VDC	Maximum	Yes
T - G	500.0 VDC	Maximum	Yes
R - G	500.0 VDC	Maximum	Yes
Test Thresholds - Current:			
AC Current			
Pair	Current	Type	Enabled
T - R	50.0 mA	Maximum	No
T - G	50.0 mA	Maximum	No
R - G	50.0 mA	Maximum	No
DC Current			
Pair	Current	Type	Enabled
T - R	50.0 mA	Maximum	No
T - G	50.0 mA	Maximum	No
R - G	50.0 mA	Maximum	No

TDR Parameter

The **TDR Parameters** page displays the parameter values of the TDR results.

Test Parameters:	
TDR	
Parameter	Value
Range	Auto
Gain	Auto
Pulse Width	Auto

Multimeter 2 Threshold

Test Thresholds - Resistance:			
Pair	Resistance	Type	Enabled
T - R	500.00 kΩ	Maximum	Yes
T - G	500.00 kΩ	Maximum	Yes
R - G	500.00 kΩ	Maximum	Yes
Test Thresholds - Resistive Balance:			
Resistive Balance	Type	Enabled	
5.00 Ω	Maximum	No	
Resistive Balance	Type	Enabled	
97 %	Minimum	Yes	
Test Thresholds - Isolation:			
Pair	Resistance	Type	Enabled
T - R	500.00 MΩ	Minimum	Yes
T - G	500.00 MΩ	Minimum	Yes
R - G	500.00 MΩ	Minimum	Yes
Test Thresholds - Opens:			
Capacitive Balance	Type	Enabled	
90 %	Minimum	Yes	

The **Multimeter 2 Threshold** page displays the **Test Thresholds** and limits for the following tests:

- **Resistance** displays values for each **Pair**.
- **Resistive Balance** displays values for the test, in Ω and %.
- **Isolation** displays the **Resistance** thresholds for each **Pair**.
- **Capacitance/Opens** displays the **Capacitive Balance** threshold for the test.

Test Thresholds

The Test Thresholds pages display read-only threshold values for each test.

Noise Threshold

Test Thresholds - VF Noise:			
VF Noise	Type	Enabled	
20 dBRN	Maximum	Yes	

Test Thresholds - Power Influence:			
Power Influence	Type	Enabled	
80 dBRnc	Maximum	Yes	

Test Thresholds - VF Impulse Noise:			
Low Counter Power:	60 dBRN		
Power Threshold Separation:	6 dB		
Mid Counter	Type	Enabled	
500	Maximum	Yes	

Test Thresholds - WB PSD Noise:			
RMS Noise	Type	Enabled	
20 dBRN	Maximum	Yes	

Test Thresholds - WB Impulse Noise:			
Power Detection Level:	60 dBRN		
Counter	Type	Enabled	
5000	Maximum	Yes	

The **Noise Threshold** page displays the **Test Thresholds** and limits for the following tests:

- **VF Noise**
- **Power Influence**
- **VF Impulse Noise** displays the **Mid Counter** threshold value and limit as well as the **Low Counter Power** and **Power Threshold Separation**.
- **WB PSD Noise** displays the **RMS Noise** and limit.
- **WB Impulse Noise** displays the **Power Detection Level**, **Counter** threshold value and limit.

Frequency Threshold 1

The **Frequency Threshold 1** page displays the **VF/AC Balance (Active)** and **WB Balance** threshold values and limits.

Test Thresholds - VF Balance (Active):		
VF Balance	Type	Enabled
59 dB	Minimum	Yes

Test Thresholds - WB Balance:			
Parameter	Value	Type	Enabled
Good Balance (ISDN)	0 dB	Minimum	No
Marginal Balance (ISDN)	0 dB	Minimum	No
Good Balance (HDSL)	0 dB	Minimum	No
Marginal Balance (HDSL)	0 dB	Minimum	No
Good Balance (SHDSL)	0 dB	Minimum	No
Marginal Balance (SHDSL)	0 dB	Minimum	No
Good Balance (ADSL)	0 dB	Minimum	No
Marginal Balance (ADSL)	0 dB	Minimum	No
Good Balance (ADSL2+)	55 dB	Minimum	No
Marginal Balance (ADSL2+)	50 dB	Minimum	No
Good Balance (VDSL2-8)	55 dB	Minimum	Yes
Marginal Balance (VDSL2-8)	50 dB	Minimum	Yes
Good Balance (VDSL2-12)	55 dB	Minimum	Yes
Marginal Balance (VDSL2-12)	50 dB	Minimum	Yes
Good Balance (VDSL2-17)	38 dB	Minimum	Yes
Marginal Balance (VDSL2-17)	35 dB	Minimum	Yes

Frequency Threshold 2

The **Frequency Threshold 2** page displays **WB Attenuation** and **Return Loss** test threshold values and limits.

Test Thresholds - WB Attenuation:			
Parameter	Value	Type	Enabled
Attenuation (ISDN)	65 dB	Maximum	No
Attenuation (HDSL)	65 dB	Maximum	No
Attenuation (SHDSL)	65 dB	Maximum	No
Attenuation (ADSL)	65 dB	Maximum	No
Attenuation (ADSL2+)	65 dB	Maximum	No
Attenuation (VDSL2-8)	65 dB	Maximum	No
Attenuation (VDSL2-12)	65 dB	Maximum	No
Attenuation (VDSL2-17)	65 dB	Maximum	No
Attenuation (VDSL2-30)	65 dB	Maximum	No
Attenuation (VDSL2-35)	65 dB	Maximum	No

Test Thresholds - Return Loss:		
Return Loss	Type	Enabled
15 dB	Minimum	Yes

Section 16 Maintenance

16.1 General Maintenance

The 6100-Cu has been designed to be a rugged and lightweight piece of test equipment. The 6100-Cu LCD display should only be cleaned using a soft, lint-free cloth and an anti-static cleaning solution. Ordinary detergents and other cleaning solutions may cloud or scratch the surface and should be avoided.

To help ensure long, trouble-free operation:

- Keep the unit free of dust.
- Clean the unit casing and front panel with a cloth slightly dampened with water.
- Store unit at room temperature in a clean and dry area. Keep the unit out of direct sunlight.
- Avoid high humidity or significant temperature fluctuations.
- Avoid unnecessary shocks and vibrations.
- If any liquids are spilled on or into the unit, turn off the power immediately and let the unit dry completely.

WARNING. *The use of controls, adjustments and procedures other than those specified herein may result in exposure to hazardous situations or impair the protection provided by this unit.*

16.2 Recalibrating the Unit

Radiodetection manufacturing and service center calibrations are based on the ISO/IEC 17025 standard (*General Requirements for the Competence of Testing and Calibration Laboratories*). This standard states that calibration documents must not contain a calibration interval and that the user is responsible for determining the re-calibration date according to the actual use of the instrument.

The validity of specifications depends on operating conditions. For example, the calibration validity period can be longer or shorter depending on the intensity of use, environmental conditions and unit maintenance, as well as the specific requirements for your application. All of these elements must be taken into consideration when determining the appropriate calibration interval of this particular Radiodetection product.

Under normal use, the recommended interval for your 6100-Cu is: *2 years*.

For newly delivered units, Radiodetection has determined that the storage of this product for up to six months between calibration and shipment does not affect its performance.

To help you with calibration follow-up, Radiodetection provides a special calibration label that complies with the ISO/IEC 17025 standard and indicates the unit calibration date and provides space to indicate the due date. Unless you have already established a specific calibration interval based on your own empirical data and requirements, Radiodetection would recommend that the next calibration date be established according to the following equation:

Next calibration date = Date of first usage (if less than six months after the calibration date) + Recommended calibration period (2 years)

To ensure that your unit conforms to the published specifications, return it to Radiodetection for calibration. Calibrations are performed using standards traceable to national metrology institutes.

16.3 Battery

The 6100-Cu is equipped with a Lithium-Polymer battery.



WARNING. *Recharge the battery using only the 6100-Cu and with the battery properly installed in the unit.*

WARNING. *Never open the battery back panel of the 6100-Cu without reading the Replacing the Battery section in this chapter.*

When fully charged, the battery should provide between 3 and 10 hours of power depending on different factors such as: type of tests performed, display backlight level, and connected accessories.

Note: *When the battery level is very low, tests cannot be performed. Plug in the AC/DC adapter for continued operation and to recharge the battery. However, the charge speed will be reduced. If the voltage detection beeper sounds when the unit is plugged in, remove the AC/DC adapter.*

To maximize the battery power of the 6100-Cu:

1. Lower the display backlight level, using the application found in **Display and Language** in the **System Settings** section, when the unit is used under low to medium light conditions.
2. Disconnect any unused USB or SD accessories.
3. Quit any running tests when the 6100-Cu is not in use.
4. Whenever possible, put the unit in suspend mode by pressing  until the suspend notification sound plays, about 2 seconds.
5. When not in use, turn the unit off by pressing  for at least 4 seconds.

If the battery capacity remains low or outside the previously stated values, it should be replaced. This could occur after 3 years depending on the usage. If your current battery capacity is lower than 8000 mAh, replace the battery.

 **WARNING:** Do not tamper with, or attempt to disassemble the battery packs.

CAUTION: If battery failure is suspected return the entire unit to an authorized repair center for investigation and repair. Local, national or IATA transport regulations may restrict the shipment of faulty batteries. Check with your courier for restrictions and best practice guidelines. Your local Radiodetection representative will be able to direct you to our authorized repair centers.

 **WARNING:** Batteries can get hot after prolonged use at full output power. Take care while replacing or handling batteries.

Unit Temperature Handling

When the battery temperature reaches $\geq 55^{\circ}\text{C}$, the unit temperature is displayed in the bar at the top of the unit and a warning message will appear. Tests stop automatically when the battery temperature reaches 60°C .

 **WARNING:** Exposing the battery to a high temperature above 60°C (140°F) may activate safety systems and cause a permanent battery failure.

Replacing the Battery

WARNING: Only use a manufacturer-supplied battery. Batteries from other suppliers could result in serious damage to the 6100-Cu or personal injuries. See the back page of this manual for Radiodetection contact information.

Battery replacement should only be done by a qualified technician with the appropriate tools on an electronic bench or similar environment.

To replace the battery:

1. Remove all 4 screws of the battery back panel using a 1.5 mm Allen key. Put aside the screws and the panel keeping the inside foam seal clean. See [LED Statuses](#) on page 154, Section 17.2.
2. Pull out the old battery using your fingers. Flipping the unit, battery-side down, will ease removal. Do not use tools in order to prevent damage to the battery envelope. Pull out the electrical connector. Put aside the old battery.
3. Remove the new battery from its package. Keep the package for future use. Plug in the electrical connector ensuring the pins are correctly aligned. Place the new battery in the 6100-Cu.
4. Inspect the inside rib around the 6100-Cu battery compartment to make sure it is free from any debris. Remove any debris using a dry cloth. Replace the battery back panel. Replace the 4 screws with a moderate torque so the foam seal is evenly compressed without damaging the screws.

Battery Charging and Replacing

Charging the 6100-Cu battery can take up to 5 hours. This battery was custom made for your unit; replacement batteries must be ordered from Radiodetection.

16.4 Recycling and Disposal

Disposal



This symbol on the product, accessories or literature indicates that the product and its electronic accessories (for example, charger, headset and USB cable) must not be treated as domestic waste, but must be disposed of professionally. It is your responsibility to dispose of your waste equipment by handing it over to a

designated collection point for the recycling of waste electrical and electronic equipment. The separate collection and recycling of your waste equipment at the time of disposal will help to conserve natural resources and ensure that it is recycled in a manner that protects human health and the environment. For more information about where you can drop off your waste equipment for recycling, please contact your local city office, your disposal service or product supplier.

Please dispose of this device in a manner appropriate to the relevant legal requirements at the end of its product life.



Batteries should be disposed of in accordance with your company's work practice, and / or the relevant laws or guidelines in your country or municipality.

For complete recycling/disposal information as per European Directive WEEE 2002/96/EC, visit www.radiodetection.com

Section 17 Troubleshooting

17.1 Solving Common Problems

The table below presents common problems and their solution.

Problem	Possible cause	Solution
The unit does not turn on	You did not press  long enough	Press  for a few seconds
	Battery is discharged	Charge battery by connecting the AC adapter/charger
	Battery is missing	Insert a battery and replace battery back panel
	Unit temperature is too cold or too hot	Make sure that the unit is within the operation temperature range. You might have to wait for the unit to warm up/cool down
The battery does not charge as expected	Temperature is too high	Ensure temperature is within specifications
	Battery is connected incorrectly	Ensure battery is connected properly
A battery status LED is red	Battery temperature is too high	<ul style="list-style-type: none"> > Shut down the unit by pressing  and holding it down for more than 10 seconds and/or until the power LED goes off > Wait for the unit to cool down, and then reboot it
	Battery is defective	Contact Radiodetection or replace the battery
The unit is not responding		<ul style="list-style-type: none"> > Shut down the unit, as above > Turn the unit on again to reset it

17.2 LED Statuses

The left-side *power* and right-side *battery* LEDs are used to indicate specific statuses of your unit. If you notice that one of the LEDs displays a particular status, please see the table below to determine what could be causing it.

Power State	Power Source	Charger State	Battery Level	Power LED	Battery LED	
ON	DC	Error	N/A	Solid green	Red	
		Charging	N/A		Green blinking	
		Charged	Full		Solid green	
	Battery	N/A		< 13 %	Solid yellow	Red blinking
				≥ 14 % - < 37 %		Yellow blinking
				≥ 38 % - < 62 %		Yellow
				> 63 %		Solid Green
Fake suspend †	DC	Error	N/A	Solid green	Red	
		Charging	N/A		Green blinking	
		Charged	Full		Solid green	
Suspend	Battery	N/A	N/A	Yellow blinking	Black	
OFF	Battery	N/A	N/A	Black	Black	

† Fake Suspend - When AC/DC is plugged in, the 6100-Cu will simulate the suspend mode by turning off the display in order to facilitate the charge

17.3 Transportation

Maintain a temperature range within specifications when transporting the unit. Transportation damage can occur from improper handling. The following steps are recommended to minimize the possibility of damage:

- Pack the unit in its original packing material when shipping.
- Avoid high humidity or large temperature fluctuations.
- Keep the unit out of direct sunlight.
- Avoid unnecessary shocks and vibrations.

Section 18 Software License Agreement (“Agreement”)

This Software License Agreement (“Agreement”) shall apply to the Customer, for all its request for quotations and purchase orders, Radiodetection order acknowledgements and invoices and any delivery of Software by Radiodetection, for which there is no separate license agreement between Customer and the manufacturer or owner of the software.

Important: by ordering, installing, downloading, or using the Software or otherwise proceeding, together with any transaction after receipt of the Agreement, or by clicking on the accept button or similar button, you, as the individual or single entity acquiring the software (the “Customer”), or as the User (as hereinafter defined) signify that you have read and accepted the terms and conditions of this agreement as of the date on which you first order the software, install, download, use or click the accept button (the “effective date”). If you do not accept this Agreement, you should not order, install, download, nor use the software and contact Radiodetection for a refund, if applicable.

Terms and Conditions

18.1 DEFINITIONS

- 18.1.1 “Documentation” means the online or electronic information manual or other printed materials that (i) contain operating instructions and performance specifications for the Software and; (ii) is delivered with the Software; and (iii) which is available to all users of the Software.
- 18.1.2 “**Open Source Software**” means individual software components that are provided with the Software, for which the source code is made generally available, and that are licensed under the terms of various published open source software license agreements or copyright notices accompanying such software components which include without limitation any software licenses approved as open source licenses by the Open Source Initiative or any substantially similar licenses.
- 18.1.3 “**Product**” means any hardware product developed by or on behalf of Radiodetection designed for use with the Software, as the case may be.
- 18.1.4 “**Software**” means the software programs and software components in object code, source code or other format and all modifications, updates, upgrades and enhancements that is developed by Radiodetection or is procured by Radiodetection for resale to customers and that Radiodetection agrees to deliver or make available to Customer from time to time.
- 18.1.5 “**Third Party/ies**” means any individual, corporation, partnership, association or other entity, other than the parties to this Agreement, but excluding any direct supplier of software procured by Radiodetection for resale to customers.
- 18.1.6 “**Third Party Software**” means the software program/s distributed by Radiodetection as part of the Software that has been developed by Third Party/ies or their licensors and may include Open Source Software.
- 18.1.7 “**Users**” means Customer’s officers, employees, and independent agents and contractors, who are bound by enforceable obligations to use the Software only on behalf of the Customer and only in accordance with this Agreement.

18.2 PROPRIETARY RIGHTS

The Customer acquiring a license to the Software is granted only those rights expressly conferred by the license grant set forth in Section 3 of this Agreement. The Software is licensed, not sold. Title to the Software and the Documentation shall not be passed to Customer, Users or to any other party. The Customer shall not acquire ownership of all rights, titles and interests, in and to the intellectual property rights related to the Software and the Documentation, including but not limited to, patent, trademark, copyrights, trade names, trade secrets, other similar rights, and intellectual property rights that could result from any alterations, attachments and improvements made by either party. Title in the Third Party Software or the Open Source Software remains with the Third Party licensors, as applicable. Customer and Users shall not, remove or modify any Software and Documentation markings or any notices of Radiodetection's or its Third Party licensors' proprietary rights.

18.3 LICENSE GRANT

- 18.3.1 License Grant.** Subject to the terms and conditions of this Agreement, Radiodetection grants to Customer a personal, non-sublicensable, non-transferable and non-exclusive license to have Users install and use the Software in accordance with the Documentation and solely within Customer's own personal or business operations, as the case may be. Radiodetection's license grant is conditioned on Customer's continuous compliance with all limitations and license restrictions described herein and in the Documentation and if Customer violates any of these limitations and restrictions or any other terms of this Agreement, the license grant will automatically and immediately terminate without notice from Radiodetection. Any usage of the Software outside one of the following scopes constitutes an infringement of Radiodetection's and/or its Third Party licensor's intellectual property and/or proprietary rights as well as a material breach of this Agreement.
- 18.3.1.1 Standard.** The license grant of section 3.1 is granted solely to install the Software on either (i) one (1) Radiodetection designated Product; (ii) one (1) stand-alone computer; or (iii) one (1) mobile device, neither of which may be connected to a network in a manner that allows more than one (1) User to upload, access, run or generally use the Software concurrently.
- 18.3.1.2 Simulator Multi-User.** In the case of Simulator Products, the license grant of section 3.1 is granted solely to use the Software in connection with one (1) Radiodetection designated Simulator Product and multiple Users may upload, access, run or generally use the Software concurrently subject to the hardware capabilities of the Simulator Product purchased by the Customer. Notwithstanding anything to the contrary herein, Users may customize or modify the Software standard package to meet Customer's specific needs as allowed by the script environment.
- 18.3.1.3 Server Access.** For any Software that allows or grants access to a server, the license grant of section 3.1 is granted solely for the purpose of accessing the server that enables administration of User accounts and performs services as specified in the Documentation, such as data storage. Customer shall use the Software only with one (1) stand-alone Product or supported device within a server-configured time period or server access enablement, and shall be responsible for the administration of the User accounts and the Users' use of the Software. The Users may use the Software on behalf of the Customer for Customer's business activities as described in section 3.1 above, subject to the terms of this Agreement. The Customer shall purchase a license or subscription, as the case may be, for each User accessing the server. Radiodetection reserves the right to discontinue Server Access to Customer and its Users upon non-payment of appropriate and associated maintenance or subscription fees. Unless otherwise agreed in writing, the license grant for Server Access is limited to a period of 1 year from the date of purchase.
- 18.3.2 Copies.** Unless otherwise agreed in writing, Customer may, when applicable with the type of Software, only make one (1) copy of the Software for backup and disaster recovery purposes provided that any copy or portion thereof must bear the same proprietary and/or copyright notices contained in or on the original copy.

18.4 LICENSE RESTRICTIONS

- 18.4.1 No right is granted (i) for the use of the Software for or in the interest of any Third Party, including, but not limited to, use for timesharing, service bureau, subscription service, hosting, outsourcing or other similar services; or (ii) to sell, transfer, export, license or sublicense any of the Software.
- 18.4.2 Customer shall not translate or create any derivative works based on the Software or Documentation or reverse engineer, decompile, disassemble or decode in whole or in part the Software or the Product or derive any source code or algorithms from the Software nor modify or alter the Software, the Product or the Documentation in any other manner whatsoever.
- 18.4.3 Customer shall not copy or use the Software or Documentation for any purpose or in any manner not expressly permitted in this Agreement.
- 18.4.4 Customer shall not remove or modify any program markings or any notice of Radiodetection's or its Third Party licensors' proprietary rights.
- 18.4.5 The validity of this Agreement is subject to the payment of all applicable license or maintenance fees by Customer to Radiodetection as the case may be and as indicated in the applicable Radiodetection invoice, if any.
- 18.4.6 The Third Party Software provided to Customer is distributed under the terms of the license agreements associated with that Third Party Software. Copies of these terms are included in the Documentation otherwise this Agreement shall govern the use of any Third Party Software by Customer. Radiodetection may designate any Third Party licensors as a third party beneficiary of this Agreement (the "Third Party Beneficiary") solely with regards to the distribution of such Third Party Software but this Agreement shall not be enforceable by the Third Party Beneficiary without a prior written agreement duly executed with Radiodetection. Notwithstanding anything else to the contrary in this Agreement, Radiodetection expressly disclaims any warranty, responsibility or liability with regard to the Third Party Software, including the downloading and installation, if applicable.
- 18.4.7 Software may contain Open Source Software. Open Source Software is composed of a variety of individual software components, each of which has its own copyright and its own applicable license conditions. Customer must review the licenses within the individual packages to understand its rights under them. The licenses can be found in each Software and/or the Documentation. Notwithstanding anything else to the contrary in this Agreement, Radiodetection expressly disclaims any warranty, responsibility or liability with regard to Open Source Software.
- 18.4.8 The Software may use Google Analytics, an analytics service provided by Google, Inc. ("Google") or any other similar analytics services. Anonymous information may be collected about Customer's use of the Software and such information will be transmitted to and stored on Google or third party servers. This information will be used for the purpose of compiling reports on the Software's activity. This information may also be transferred to other parties where required to do so by law, or where such parties process the information collected by the analytics services.

18.5 RESERVED RIGHTS

- 18.5.1 Title in the Software remains with Radiodetection. Title in the Third Party Software and Open Source Software remains with the Third Party providers.
- 18.5.2 Radiodetection reserves any rights not expressly granted in Section 3 and nothing in this Agreement constitutes a waiver of Radiodetection's rights under copyright laws or any other federal or state law or treaty. Without limiting the foregoing, Radiodetection reserves the right to license the Software to others on such terms as Radiodetection may establish in its sole discretion.
- 18.5.3 Radiodetection reserves the right, in any way and without notice, to revise, not to revise, update or modify the Software, or the information upon which the Software was based. Except as otherwise expressly set forth in this Agreement, Radiodetection assumes no responsibility, for (i) protecting the Software against

obsolescence; (ii) providing any improvements to the Software; (iii) maintaining the Software; or (iv) providing other services with respect to the Software.

18.6 COOKIE AND PRIVACY POLICY

If the use of the Software allows connection to a Radiodetection Server and/or Third Party's Server, Customer and Users consent to Radiodetection's collection, use and disclosure of information associated with the Software solely in accordance with Radiodetection's and/or Third Party's Cookie and Privacy Policy, as it may be updated by Radiodetection or Third Party from time to time.

18.7 AUDIT

When applicable, Radiodetection reserves its right to verify, upon reasonable notice, Customer's use of the Software in compliance with the terms of this Agreement and audit all books and financial records related to such use. Customer agrees to pay within 30 days of written notification any underpaid fees. If the Customer does not pay, Radiodetection can end Customer's support, licenses and this Agreement. Radiodetection shall have the right to disclose the result of such audit to its Third Party Software licensors to the extent that such audit results in findings concerning such Third Party Software licensor.

18.8 SUPPORT

Radiodetection shall only provide support for the Software to the extent set forth in a separate maintenance agreement or support program, if any, between Radiodetection and Customer.

18.9 CONFIDENTIAL INFORMATION

- 18.9.1 Customer shall hold the Software, the Third Party Software and the Documentation in strict confidence for the benefit of Radiodetection as confidential information.
- 18.9.2 Customer shall not make any disclosure of the Software and/or Third Party Software (including methods or concepts utilized in the Software and/or Third Party Software) to anyone other than its Users who have a need to know provided that Customer shall be responsible for the use of the Software by its Users. Customer shall notify its Users of their confidentiality obligations with respect to the Software and the Documentation and shall require its Users to comply with these obligations. The confidentiality obligations of Customer and its Users shall survive the termination of Customer's licenses and rights granted under this Agreement.
- 18.9.3 Customer shall not disclose results of any Software or Product benchmark tests without Radiodetection's prior written consent.
- 18.9.4 Radiodetection shall have the right to disclose, without Customer's consent, the terms of this Agreement to Radiodetection's Third Party Software licensors.

18.10 LIMITED WARRANTY AND EXCLUSIVE REMEDY

Radiodetection warrants that for a period of sixty (60) days from the date of delivery ("Warranty Period"), that the Software will operate and perform materially in conformance with the Documentation. If a breach of the warranty set forth in this Section 10 occurs, Customer's sole and exclusive remedy is that Radiodetection will provide reasonable efforts to correct non-conformances which are reproducible by Radiodetection during the Warranty Period. If the use of the Software allows connection to a Radiodetection Server, during any subscription term, Radiodetection will use commercially reasonable efforts to make the Radiodetection server generally available except for planned downtime or downtime caused by circumstances beyond Radiodetection's reasonable control.

18.11 DISCLAIMER

Radiodetection makes no representations and extends no warranties of any kind (other than those set forth in Section 10) with respect to (i) the use, sufficiency or accuracy of the Software; (ii) the sufficiency or accuracy of the reports or tests performed utilizing the Software; (iii) any Third Party Software and Open Source Software; (iv) any Third Party websites or links (including hyperlinks) thereto; or (v) the availability of the Software, the Radiodetection server or that the Software or the Radiodetection server performance will perform error-free and uninterrupted. To the extent permitted by applicable law, the foregoing warranties are in *lieu* of all other warranties, either expressed or implied, including, but not limited to, the implied warranties of merchantability, fitness for any particular purpose (even if Radiodetection knows or has been made aware of such purpose), and the warranty against infringement of patents or other intellectual property rights. The software is not fault-tolerant and is not designed, manufactured, or intended for use in hazardous environments that require fails-safe performance such as in the operation of nuclear facilities, aircraft navigation or communications systems, air traffic control, emergency response, terrorism prevention or response, life support or weapons systems ("high risk activities") the failure of which could lead to death, personal injury, or severe physical or environmental damage. Radiodetection expressly disclaims any warranty of fitness for high risks activities.

18.12 LIMITATION OF LIABILITY

Radiodetection and /or the Third Party is not liable for any indirect damages, lost profits, incidental or consequential damages, arising out of this Agreement or the furnishing of the Software or Third Party Software, websites or links (including hyperlinks) thereto, including the use or inability to use the Software or the Third Party Software, websites or links (including hyperlinks) thereto, even if Radiodetection knows or has been made aware of the possibility or likelihood of such damages. Radiodetection is not responsible for any compensation, reimbursement, or damages arising in connection with: Users inability to use the Software as a result of any unanticipated or unscheduled downtime of all or a portion of the Radiodetection and/or Third Party server for any reason, including as a result of power outages, system failures or other interruptions. Radiodetection's and/or its Third Party's liability under this Agreement, if any, is limited to i) the annual license fees for subscription license or (ii) the total license fees actually received by Radiodetection for the Software. If any remedy hereunder is determined to have failed of its essential purpose, all limitations of liability, disclaimers and exclusions of warranty and damages set forth in this agreement shall remain in effect.

18.13 TERM AND TERMINATION

- 18.13.1 The term of this Agreement will commence on the Effective Date and will remain in effect until expiration of Customer's subscription licenses, if applicable, or until termination in accordance with Section 13.2.
- 18.13.2 This Agreement and the license and rights granted to Customer under this Agreement will automatically terminate without notice to Customer if (i) Customer assigns the license for the benefit of creditors; (ii) Customer admits in writing its inability to pay debts as they mature; (iii) a trustee or receiver is appointed for a substantial part of Customer's assets; (iv) a bankruptcy proceeding is instituted against Customer which is acquiesced in and is not dismissed within sixty (60) days, or results in an adjudication of bankruptcy; or (v) Customer breaches the license granted in Section 3 or breaches any of the restrictions of Section 4.
- 18.13.3 Without prejudice to any other rights, Radiodetection may terminate this Agreement if Customer fails to comply with any term or condition of this Agreement.
- 18.13.4 Upon termination of this Agreement, Customer shall return the Software and the Documentation, including all copies and, if requested, certify in writing to Radiodetection the return. Customer is bound by all obligations incurred prior to the termination; however, all of Radiodetection's obligations will automatically terminate upon termination. Radiodetection is under no obligation to refund any monies because of termination. These termination rights are in addition to all other rights and remedies available to Radiodetection.

18.14 GENERAL

- 18.14.1 Neither the execution of this Agreement or anything in it, or the Software, shall be construed as providing nor implying any arrangement or understanding that Radiodetection will make any purchase, lease, examination or test of, or give any approval with respect to, any product or service.
- 18.14.2 Customer may not assign, in whole or in part, this Agreement, or any license, rights or obligations granted, to any Third Party, including without limitation, any subsidiary, affiliate or entity owned or controlled by Customer, or pursuant to any merger, consolidation or other Customer reorganization, without the prior written consent of Radiodetection.
- 18.14.3 The failure of either party at any time to enforce any of the provisions of this Agreement or any right under this Agreement, or to exercise any option provided, will in no way be construed to be a waiver of the provisions, rights, or options, or in any way to affect the validity of this Agreement. The failure of either party to exercise any rights or options under the terms or conditions of this Agreement shall not preclude or prejudice the exercising of the same or any other right or option under this Agreement.
- 18.14.4 This Agreement must be construed and enforced according to the laws applicable in the province of Quebec, Canada, without regards to its conflict of laws provisions. The parties specifically exclude the application of the United Nations Convention on Contracts for the International Sale of Goods and the Uniform Computer Information Transactions Act.
- 18.14.5 If any provision or portion of a provision of this Agreement is held invalid or unenforceable, the remainder of the Agreement shall not be affected, and the remaining terms will continue in effect and be binding on the parties, provided that such holding of invalidity or unenforceability does not materially affect the essence of the Agreement.
- 18.14.6 Customer agrees to comply with all applicable laws. Specifically, Customer will comply with all applicable export and import control laws and regulations of the United States and any foreign jurisdiction in which the Software is used and, in particular, Customer will not export or re-export the Software without all required United States and foreign government licenses. Customer acknowledges and understands that the Software contains encryption technology that may require an export license from the U.S. State Department when exported or re-exported to government end-users, Internet or telecommunications service providers providing services specific to government end-users. Export of the Software to certain countries is

prohibited. Customer will defend, indemnify, and hold harmless Radiodetection from and against any violation of such laws or regulations by Customer or any of its agents, officers, directors, or employees.

- 18.14.7 The provisions of this Agreement constitute the entire agreement between the parties with respect to the licensing of the Software and supersede (i) all prior agreements, oral or written; (ii) any conflicting terms in Customer's purchase order or Radiodetection's invoice; and (iii) all other communications relating thereto. All Sections that by their sense and context are intended to survive the execution, delivery, performance and termination of this Agreement, will survive and continue in effect.
- 18.14.8 Any references to information contained in an URL form an integral part of this Agreement and the Customer hereby confirms that it has access to the Internet and confirms that prior to entering into this Agreement has read and agrees with the terms and conditions set out in those documents.
- 18.14.9 **U.S. GOVERNMENT END USERS.** The Software and any other software covered under this Agreement is a "commercial item" as that term is defined at 48 C.F.R. 2.101, consisting of "commercial computer software" and "commercial computer software documentation" as such terms are used in 48 C.F.R. 12.212. Consistent with 48 C.F.R. 12.212 and 48 C.F.R. 227.7202-1 through 227.7202-4, all U.S. Government End User Customers acquire the Software with only those rights set forth therein.

END OF TERMS AND CONDITIONS

CONTACT INFORMATION: If you have any questions about this Agreement, please direct all correspondence to: Radiodetection Ltd. Western Drive, Bristol BS14 0AF, UK. Legal notice shall be sent to the attention of the Radiodetection Legal representative.

Due to a policy of continued development, we reserve the right to alter or amend any published specification without notice. This document may not be copied, reproduced, transmitted, modified or used, in whole or in part, without the prior written consent of Radiodetection Ltd.

Information provided by Radiodetection is believed to be accurate and reliable. However, no responsibility is assumed by Radiodetection for its use nor for any infringements of patents or other rights of third parties that may result from its use. No license is granted by implication or otherwise under any patent rights of Radiodetection or third parties

Visit www.radiodetection.com

Global locations

Radiodetection (USA)

28 Tower Road, Raymond, Maine 04071, USA

Toll Free: +1 (877) 247 3797 Tel: +1 (207) 655 8525 rd.sales.us@spx.com

Schonstedt Instrument Company (USA)

100 Edmond Road, Kearneysville, WV 25430 USA

Toll Free: +1 888 367 7014 Tel: +1 304 724 4722 schonstedt.info@spx.com www.schonstedt.com

Radiodetection (Canada)

Unit 34, 34-344 Edgeley Blvd. Concord, Ontario, ON L4K 4B7, Canada

Toll Free: +1 (800) 665 7953 Tel: +1 (905) 660 9995 rd.sales.ca@spx.com

Radiodetection Ltd. (UK)

Western Drive, Bristol, BS14 0AF, UK

Tel: +44 (0) 117 976 7776 rd.sales.uk@spx.com

Radiodetection (France)

13 Grande Rue, 76220, Neuf Marché, France

Tel: +33 (0) 2 32 89 93 60 rd.sales.fr@spx.com

Radiodetection (Benelux)

Industriestraat 11, 7041 GD 's-Heerenberg, Netherlands

Tel: +31 (0) 314 66 47 00 rd.sales.nl@spx.com

Radiodetection (Germany)

Groendahlscher Weg 118, 46446 Emmerich am Rhein, Germany

Tel: +49 (0) 28 5192 37 20 rd.sales.de@spx.com

Radiodetection (Asia-Pacific)

Room 708, CC Wu Building, 302-308 Hennessy Road, Wan Chai, Hong Kong SAR, China

Tel: +852 2110 8160 rd.sales.asiapacific@spx.com

Radiodetection (China)

13 Fuqianyi Street, Minghao Building D304, Tianzhu Town, Shunyi District, Beijing 101312, China

Tel: +86 (0) 10 8146 3372 rd.service.cn@spx.com

Radiodetection (Australia)

Unit H1, 101 Rookwood Road, Yagoona NSW 2199, Australia

Tel: +61 (0) 2 9707 3222 rd.sales.au@spx.com