

LMX200™

User's Guide



Product Registration

Return this card to register your product, streamline technical support inquiries and receive updates and notifications. You can mail it to Sensors & Software, fax it to +1-905-624-9365, or register your product online at www.sensoft.ca/product-registration.

Name:	Company Name:	
Address:		
City:	State/Province:	Zip Code:
Country:	e-mail:	
Phone:	Fax:	

Component Serial Numbers (refer to packing list or the sticker on the component)

Comp:	Serial #	Comp:	Serial #
Comp:	Serial #	Comp:	Serial #
Comp:	Serial #	Comp:	Serial #
Comp:	Serial #	Comp:	Serial #
Comp:	Serial #	Comp:	Serial #
Vendor Name:	Date Received:		

**SENSORS & SOFTWARE INC. PRODUCT LICENSE, COPYRIGHT, LIABILITY AND WARRANTY
INFORMATION**

Important

Please read this document carefully before using the *SOFTWARE PRODUCT* or assembling the *HARDWARE PRODUCT*. By using the storage media or assembling the hardware, you are agreeing to be bound by the terms of this agreement. If you do not agree to the terms of this agreement, promptly contact Sensors & Software, Inc. at the address indicated at the end of this document.

Definition

The word *PRODUCT* as used herein defines any item sold by Sensors & Software, Inc. and may be comprised of *HARDWARE PRODUCT* which consists of physical objects and *SOFTWARE PRODUCT* which means computer programs, codes and related support materials.

Software Product License Agreement

In order to preserve and protect its rights under the applicable laws, Sensors & Software, Inc. does not sell any rights to its Software products. Rather, Sensors & Software, Inc. grants the right to use its software, CDs, memory sticks (or other storage media) and documentation (hereafter collectively called *SOFTWARE PRODUCT*) by means of a *SOFTWARE PRODUCT* license. You acknowledge and agree that Sensors & Software, Inc. retains worldwide title and rights to all its software and that the *SOFTWARE PRODUCT* contains proprietary materials protected under copyright, trademark and trade secret laws.

Grant of Software Product License

In consideration of payment of the license fee which is the price you pay for the *SOFTWARE PRODUCT* and your agreement to abide by the terms and conditions of this License Agreement, Sensors & Software, Inc. grants to you, the Licensee, a non-exclusive right to use the *SOFTWARE PRODUCT* under the following conditions:

You may:

- use the *SOFTWARE PRODUCT* on a single workstation owned, leased or otherwise controlled by you;
- copy the *SOFTWARE PRODUCT* for backup purposes in support of your use of the product on a single workstation.

You may not:

- copy, distribute or sell copies of the *SOFTWARE PRODUCT* or accompanying written materials, including modified or merged *SOFTWARE PRODUCT* to others;
- sell, license, sublicense, assign or otherwise transfer this license to anyone without the prior written consent of Sensors & Software, Inc.;
- modify, adapt, translate, decompile, disassemble or create derivative works based on the *SOFTWARE PRODUCT*.

Termination

This license is effective until terminated. You may terminate the license at any time by returning the *SOFTWARE PRODUCT* and all copies to Sensors & Software, Inc. The license will automatically terminate

without notice by Sensors & Software, Inc. if you fail to comply with any terms or conditions of this agreement. Upon termination, you agree to return all copies of the *SOFTWARE PRODUCT* to Sensors & Software, Inc.

Update Policy

Sensors & Software, Inc. may create, from time to time, updated versions of its *SOFTWARE PRODUCT*. At its option, Sensors & Software, Inc. will make such updates available to licensees who have paid the update fee.

Product Warranty, Limited Remedy and Limited Liability

Sensors & Software, Inc. warrants the *PRODUCT* to be free from defect in material and workmanship under normal use for a period of one year (365 days) from the date of shipment. Any third-party computer systems or other items not manufactured directly by Sensors & Software, Inc. purchased with any *PRODUCT* or independently from Sensors & Software, Inc. are subject to the original manufacturer's warranty and are not the responsibility of Sensors & Software, Inc.

Sensors & Software, Inc. makes no other warranties including, but not limited to, any implied warranty of merchantability or fitness for a particular purpose. If this product is defective within the warranty period stated above, your exclusive remedy shall be, at Sensors & Software, Inc.'s option to replace or repair the Sensors & Software, Inc. product or refund the purchase price of the Sensors & Software, Inc. product. Except where prohibited by law, Sensors & Software, Inc. will not be liable for any loss or damage arising from this Sensors & Software, Inc. product, whether direct, indirect, special, incidental or consequential regardless of the legal theory asserted.

All statements, technical information, and recommendations related to Sensors & Software, Inc. products are based on information believed to be reliable, but the accuracy or completeness is not guaranteed. Before using this product, you must evaluate it and determine if it is suitable for your intended application. You assume all risks and liability associated with such use. Any statements related to the product, which are not contained in Sensors & Software, Inc. current publications, or any contrary statements contained on your purchase order shall have no force or effect unless expressly agreed upon, in writing, by an authorized officer of Sensors & Software, Inc.

Sensors & Software, Inc. warrants the CD, memory stick or other storage media on which the *SOFTWARE PRODUCT* is furnished to be free from defects in material and workmanship under normal use for a period of ninety (90) days from the date of purchase as evidenced by a copy of your invoice.

Except as specified above, any *SOFTWARE PRODUCT* is provided "as is" without warranty of any kind, either expressed or implied, including, but not limited to, the use or result of use of the product in terms of correctness, accuracy, reliability, currentness or otherwise. The entire risk as to the results and performance of the *PRODUCT* is assumed by you. If the *PRODUCT* is defective or used improperly, you, and not Sensors & Software, Inc. or its dealers, distributors, agents, or employees, assume the entire cost of all necessary servicing, repair or correction.

Sensors & Software, Inc.'s entire liability and your exclusive remedy for *SOFTWARE PRODUCT* shall be, at Sensors & Software, Inc.'s option, either:

- the replacement of any storage media (CD, memory stick etc.) or hardware components which do not meet Sensors & Software, Inc.'s Limited Warranty and which are returned to Sensors & Software, Inc. postage prepaid with a copy of the receipt, or
- if Sensors & Software, Inc. is unable to deliver a replacement storage media which is free of defects in material or workmanship, Licensee may terminate this agreement and have the license fee refunded by returning all copies of the *SOFTWARE PRODUCT* postage prepaid with a copy of the receipt.

If failure of any *PRODUCT* resulted from accident, abuse or misapplication, Sensors & Software, Inc. shall have no responsibility to replace the *SOFTWARE PRODUCT*, refund the license fee, or replace or repair the *HARDWARE PRODUCT*.

Do not tamper with any *PRODUCT*. *PRODUCT* contains no user serviceable parts. If tampering is evident in Sensors & Software, Inc.'s opinion, warranty is void and null.

No oral or written information or advice given by Sensors & Software, Inc., its dealers, distributors, agents or employees shall create a warranty or in any way increase the scope of this warranty and you may not rely on any such information or advice.

Neither Sensors & Software, Inc. nor anyone else who has been involved in the creation, production or delivery of the *PRODUCT* shall be liable for any direct, indirect, special, exemplary, incidental or consequential damages, claims or actions including lost information, lost profits, or other damages arising out of the use or inability to use this *PRODUCT* even if Sensors & Software, Inc. has been advised of the possibility of such damages.

This warranty gives you specific rights. You may have other rights which vary from province to province, territory to territory and certain limitations contained in this limited warranty may not apply to you.

General

No right, license, or interest to any Sensors & Software, Inc. trademarks is granted hereunder with the purchase of the *PRODUCT* or the *SOFTWARE PRODUCT* license.

Governing Law

In the event of any conflict between any provision in this license agreement and limited warranty and any applicable provincial legislation, the applicable provincial legislation takes precedence over the contravening provision. This agreement shall be governed and construed in accordance with the laws of the Province of Ontario, Canada.

Serviceability

Should any term of this agreement be declared void or not enforceable by any court of competent jurisdiction, the remaining terms shall remain in full effect.

Waiver

Failure of either party to enforce any of its rights in this agreement or take action against any other party in the event of a breach of this agreement shall not be considered a waiver of the right to subsequent enforcement of its rights or actions in the event of subsequent breaches by the other party.

Acknowledgement

You acknowledge that you have read this agreement, understand it and agree to be bound by its terms and conditions. You further agree that this agreement is the complete and exclusive statement of agreement between the parties and supersedes all proposals or prior agreements oral or written between the parties relating to the subject matter of this agreement.

Should you have any questions concerning this agreement, please contact in writing:

Sensors & Software Inc.

1040 Stacey Court

Mississauga, Ontario

Canada L4W 2X8

Tel:(905) 624-8909

Toll Free: 1-800-267-6013

Fax:(905) 624-9365

E-mail: customerservice@sensoft.ca

Sensors & Software, Inc. trademarks are listed at: www.sensoft.ca/trademarks

1999-00236-04

Important Safety Information

Use the Display Unit only as specified in these operating instructions or the protection provided by the unit may be impaired.

The battery charger/AC adapter must only be connected to a power outlet which provides a protective earth (ground).

Connect the AC power cord only to designated power sources as marked on the battery charger/AC adapter.

The battery charger/AC adapter is rated for indoors use only.

Do not replace detachable MAINS supply cords for the battery charger/AC adapter by inadequately RATED cords.

Do not position the Display Unit such that it is difficult to disconnect the 37-pin GPR connector.

The exterior of this product should be cleaned using a damp cloth.

Safety Symbols



Consult this documentation in all cases where this safety symbol appears. This symbol is used to inform you of any potential HAZARD or actions that require your attention.

Table of Contents

1. Overview	15
2. Assembly	17
2.1 Out of the box	17
2.2 External GPS (optional)	20
2.3 Fully Assembled	22
3. Getting Started	23
3.1 Powering Up	23
3.2 Shutting Down	25
3.3 Interacting with the Display Unit	25
3.4 Swipe Down Menu	26
4. Tools & Setup	27
4.1 Preferences	27
4.1.1 Language / Locale	28
4.1.2 Units	28
4.1.3 Date/Time	28
4.1.4 Volume	28
4.1.5 Brightness	29
4.1.6 Wi-Fi Network	29
4.1.7 Email	30
4.1.8 Screen Saver	34
4.1.9 GPR Plot Options	34
4.1.10 Reset to Defaults	35
4.2 System Test	36
4.2.1 System Information	36
4.2.2 Keypad Test	37
4.2.3 Audio	38
4.2.4 Touch Screen	38
4.2.5 Sensor Test	39
4.2.6 Odometer Calibration	40
4.2.7 GPS	42
4.3 File Management	45
4.3.1 Screenshot Gallery	45
4.3.2 Delete All Data	47
4.3.3 Delete Project (Enhanced system)	47
4.3.4 Export Data	47
5 GPR Concepts	49
5.1 Theory	49
5.2 Hyperbolas	49
5.3 Calculating Depth	50
5.4 Soil Calibration values	50
5.5 Air Waves	51
6 Line Scan	53
6.1 Selecting a line	53
6.2 Acquiring Data	55
6.3 DynaQ	55
6.4 Back-up Indicator	56
6.5 Flags	57
6.6 SplitView	58
6.7 View Settings	60

6.7.1	Zoom	61
6.7.2	Color	63
6.7.3	Filter	63
6.7.4	Gain	64
6.7.5	DynaT	65
6.7.6	Soil Cal	66
6.7.7	Interp	68
6.7.8	Pause button (only available in No Save Mode)	69
6.7.9	Drawing arrows (only available in No Save Mode)	70
7	Grid Scan	71
7.1	Grid Parameters	71
7.1.1	Grid Number	71
7.1.2	Grid Size	72
7.1.3	Grid Resolution	72
7.1.4	Starting data collection	73
7.2	Laying out the grid	73
7.3	Data Collection	76
7.3.1	Physical Data collection	76
7.3.2	Data collection on the Display Unit	76
7.3.3	Obstacles in your path	77
7.3.4	Flags	78
7.3.5	LineView	78
7.3.6	Recollecting & skipping lines	79
7.3.7	Processing data	80
8	SliceView.....	81
8.1	Depth	81
8.2	LineView	82
8.3	Color	82
8.4	Options	84
8.4.1	Grid Lines	84
8.4.2	Flags	85
8.4.3	Interps	85
8.5	Recollecting lines	85
9	MapView.....	87
9.1	Accessing MapView	87
9.2	MapView screen	88
9.2.1	Options (Layer views)	89
10	Capturing Screens & E-mailing Mini-Reports	93
10.1	Capturing Screens	93
10.2	Using the Hotspot on your Smartphone	94
10.3	Mini-Reports	95
11	Transferring Data to a PC	97
11.1	Formatting USB Sticks	98
11.2	Directory Structure	99
11.3	Field Interpretations file	100
11.4	Google Earth™	100
11.5	System Summary Report	102
11.6	EKKO_Project	103
12	Troubleshooting.....	105
12.1	Power Supply	105

12.2	System Communications	105
12.3	System Overheating	106
12.4	Display Unit Problem	106
12.5	Wobbly Wheels	106
12.6	Creating a Test Line for Data Quality	106
12.7	Contacting the Vendor for Service	107
13	Care & Maintenance	109
13.1	Battery Care	109
13.2	Cable Care	110
13.3	Skid Pads	110
13.4	Odometer	110
13.5	Storage Cases	110
13.6	Upgrading Embedded Software on Display Unit	110
14	Parts List & Accessories	113
14.1	Spare Parts	113
14.2	Accessories	115
15	Technical Specifications	117
Appendix A: Health & Safety Certification		119
Appendix B: GPR Emissions, Interference and Regulations		121
Appendix C: Instrument Interference		129
Appendix D: Safety around Explosive Devices		131
Appendix E: Wi-Fi Module		133

1. Overview

The manual references embedded software version V1 R9. To see which software version is installed on your system, see the Swipe Down menu in [Section 3.4](#).

The LMX200 is a complete Ground Penetrating Radar system, offering two modes for acquiring data: Line Scan and Grid Scan. Once the unit is assembled and powered-up, you can start conducting a GPR survey in less than a minute.

Features of the LMX200 include:

- High visibility, touch screen display
- Display depth slices from collected grids, right in the field
- UWB (ultra-wide band) Antenna producing highest data quality
- Dynamic Target Enhancement (DynaT), allows user to selectively view small, medium or large subsurface targets
- Lightweight fibreglass cart frame
- Built-in Wi-Fi capability
- Integrated GPS receiver with optional external GPS for increased positional accuracy for geo-referencing data
- Ability to mark surface flags and subsurface interpretations directly in the data
- Display your travelled path and targets in MapView
- Seamless export of data to EKKO_Project software for further data analysis

The LMX200 is also available in an Enhanced configuration. The following chart summarizes the differences between the two configurations:

Criteria	<u>LMX200</u>	<u>LMX200 Enhanced</u>
How is data saved?	Screenshots (.JPG)	Screenshots (.JPG) and .GPZ files
How much data can be saved?	<ul style="list-style-type: none"> • 10 grids • 99 lines • 999 screenshots 	9 Projects each with: <ul style="list-style-type: none"> • 10 grids • 99 lines • 999 screenshots
File organization	Lines, Grids & Screenshots	Projects containing Lines, Grids & Screenshots
PC-based data display	Any .JPG viewing software	Data can be opened in EKKO_Project

Online training videos for the LMX200 can be found on Sensors & Software's website at:

<https://www.sensoft.ca/training-events/training/lmx200-training-videos>

(Note: you will need to setup a login & password to access this)

2. Assembly

2.1 Out of the box

You will find the following components in your LMX200 box. Some of these may already be assembled.

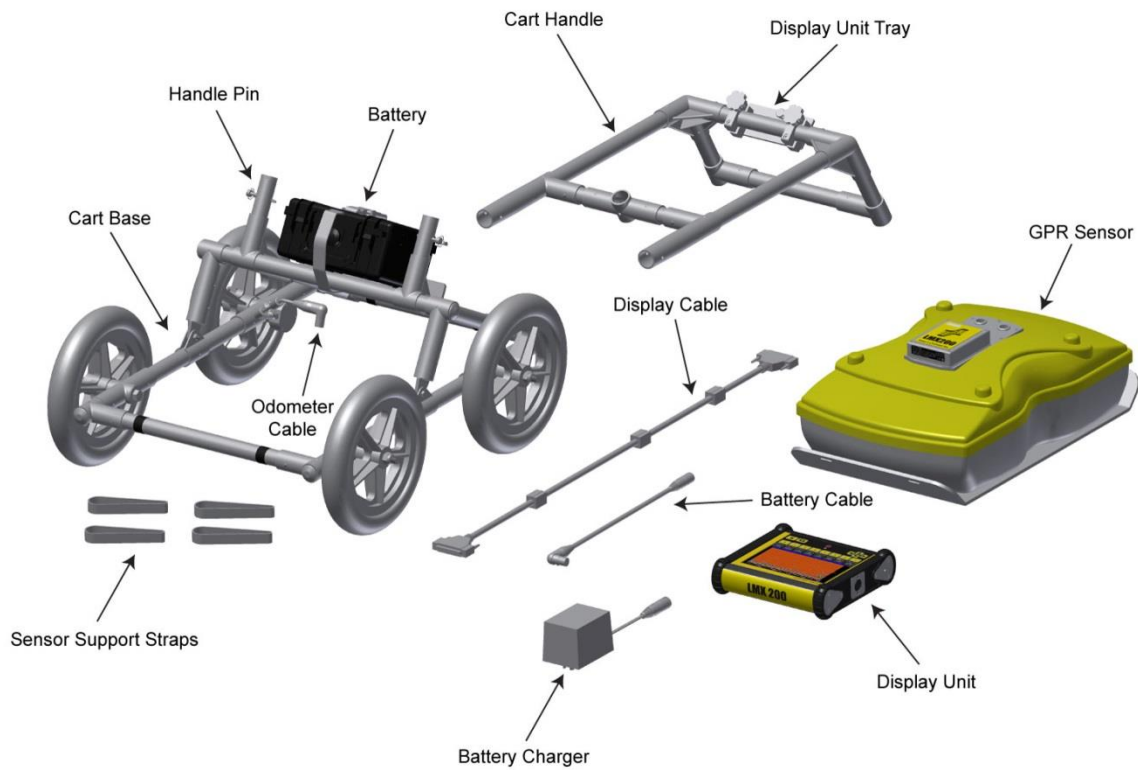

Attach the Cart Handle to Cart Base using the Handle Pins. Ensure the Display Unit Tray is facing the operator.

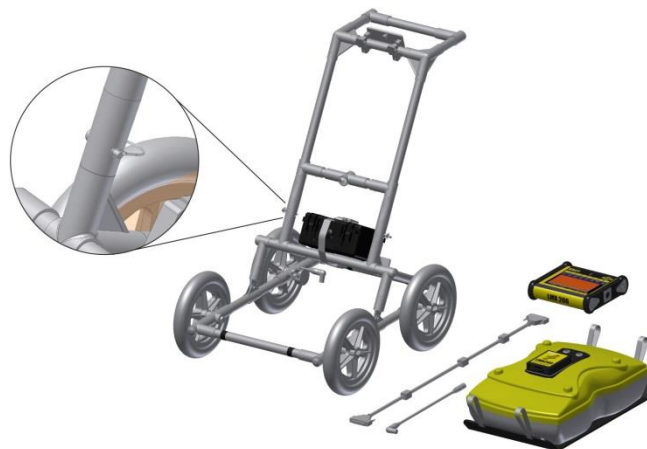

Attach the GPR Sensor to the Cart using the Sensor Support Straps. Ensure the Sensor is oriented the correct way with the connections toward the back of the Cart. Using the Sensor Support Straps, adjust the height of the Sensor so it is 1-2 cm ($\frac{1}{2}$ – $\frac{3}{4}$ inch) above the ground. The best way to get a uniform Sensor height is to place a couple of sheets of thick cardboard, particle board, or Styrofoam under the sensor before securing the Sensor Support Straps.

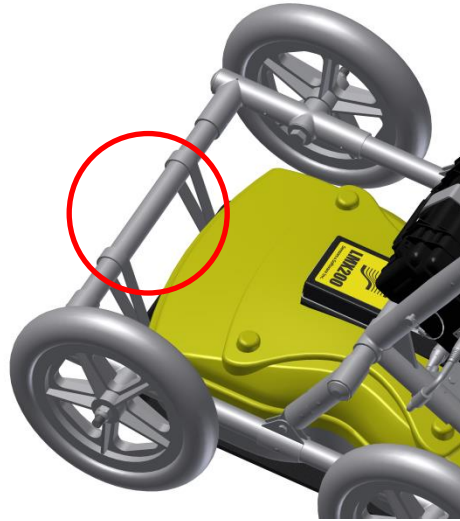

Attach the Display Unit onto the Display Unit Tray on the Cart. The Display unit slides down into the tray, catching on both sides of the mount and is held in place with the pull pin. When a click is heard, the Display Unit is firmly in place. Adjust the angle of the Display Unit by loosening the hand-screws underneath the Display Unit Tray, rotating the Display Unit to the desired angle and tightening the hand-screws. To remove the Display Unit, disconnect all cables, pull out the pull pin and lift the Display Unit up.



Attach the Display Cable to the back of the Display Unit with the jackscrews. Connect the other end of the cable to the Sensor. Ensure the cable is routed as shown below.



Attach the Odometer and Battery Cables. The Odometer Cable connects to the closest receptacle on the Sensor. Attach the Battery Cable to the Sensor and the Battery. The system is now setup and ready to use.

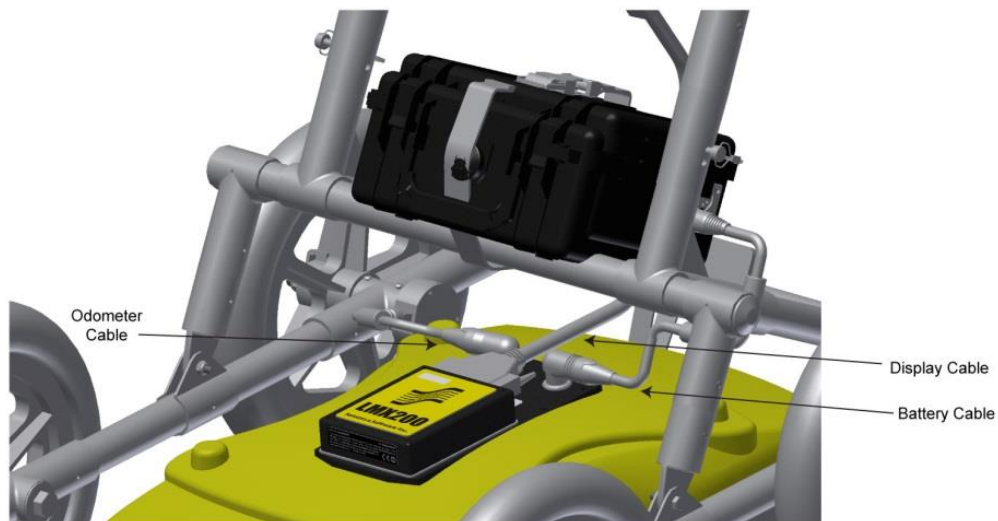

2.2 External GPS (optional)

The instructions for connecting the GPS, mount and cable are below:

GPS Mount – The GPS mount attaches to the crossbar frame above the battery, using a quick release pin. There is a pipe plug that needs to be removed first.



Once that is done, ensure the right angle pole is pointed up, then insert the GPS mount into the opening where the plug was removed and secure with the quick release pin. This allows the GPS to sit directly over the middle of the GPR sensor. It comes with 5/8-11 UNC-1A threads at the top of the pole, which is standard for many GPS receivers.



GPS – If you have purchased the Topcon GPS from Sensors & Software this can be screwed onto the threads at the top of the GPS mount. Connect one end of the GPS cable to the GPS receiver, and the other end to the serial port on the back of the Display Unit. This single cable powers the GPS and receives data from it. Ensure that the Display Unit is powered down when connecting or disconnecting the GPS cable.

If you choose to connect a 3rd party GPS receiver, it must meet the following criteria:

- Be able to communicate over RS232 with a standard 9-pin serial output cable
- Output a NMEA GGA string in ASCII format, at a rate no faster than 20 Hz
- Set the following parameters:
 - Baud rate = 19200 bps
 - Parity = None
 - Stop Bits = 1
 - Data Bits = 8
- If it cannot safely accept power via the serial port (as shown below), it must have its own battery or way of receiving power.
- GPS must not expect any handshaking from the Display Unit

NOTE: Since the serial port of the Display Unit outputs power (current=1A, voltage=12V), it is the responsibility of the user to confirm with the 3rd party GPS manufacturer that the serial cable does not provide power to the GPS or that the GPS will accept 12V power from our serial cable on the pins shown below. Sensors & Software is not responsible for damage caused to a GPS from using the serial port.

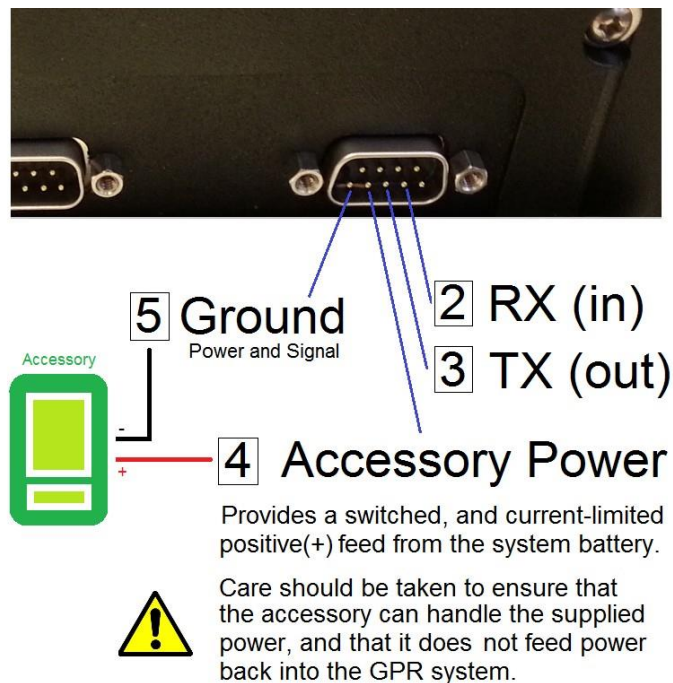

See [Section 4.2.7](#) to enable or disable power to the serial port.

2.3 Fully Assembled

The fully assembled LMX200 will look like the following. Simply reverse directions to disassemble for transport.



3. Getting Started

3.1 Powering Up

When the battery is first plugged in, the LED goes green for 5 seconds then disappears.

To start the system, press the red power button on the display unit. The LED on the front panel will light up red.



Figure 3-1: Display Unit

Once boot up is complete, the colour of the LED will indicate the amount of battery power remaining:

- 100% to 20% = green
- 20% to 10% = orange
- 10% to 0% = red

The first time you turn on the LMX200, you will need to configure the system (Figure 3-1). A series of screen prompts will allow you to setup the language, units, date & time, and some other options. You will have to do this again anytime you update the embedded software ([Section 13.6](#)).

Every subsequent time the system boots up, you will see the main screen (Figure 3-2). If you have purchased (or upgraded to) the LMX200 Enhanced system, you will see a slightly different main screen (Figure 3-3).



Figure 3-2: Main Screen for LMX200



Figure 3-3: Main Screen for LMX200 Enhanced

The differences between the two configurations are described in [Section 1](#).

From the main menu of the Enhanced system, select the project number to work in. Projects that contain data are in red color, whereas those with no data are in green. As you change projects, the main screen will also display the number of lines and grids collected in each project. These will appear under the Line Scan and Grid Scan buttons respectively.

3.2 Shutting Down





To power down, press the red power button on the display unit once. A confirmation message will appear, after which you can press **Yes** to proceed. In the rare event that the display unit is unresponsive, a hard shutdown can be done by pressing and holding the red power button until the unit shuts down.

3.3 Interacting with the Display Unit

Data collection is controlled by the Display Unit. The Display Unit has embedded software to set survey parameters and collect, display and store data.

The Display Unit offers touch screen operation, as well as a water-resistant membrane keypad with a number of buttons that can be pressed to perform various tasks. Most operations can be done using either the touch screen or the keypad.

Use the following table as a guide to working with the keypad on the Display Unit:

Item	Description
Menu Buttons 	The yellow buttons labelled 1 to 8 correspond to menu choices that appear on the screen.
4-way directional keypad 	Controls Up/Down/Left/Right operations in certain menus.
Camera 	Saves a screenshot of line data, grid data or the MapView display.
Asterisk / Special Function 	Used for adding Flags during data acquisition, and to quickly enter the No Save mode for Line Scan data collection.

3.4 Swipe Down Menu

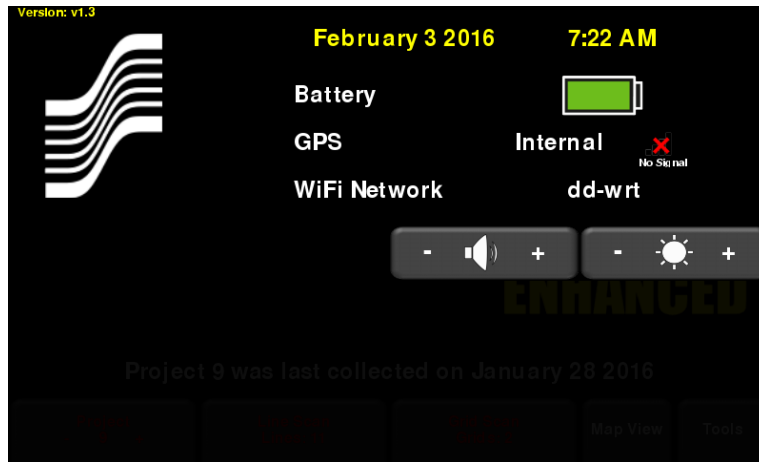

Figure 3-4: Swipe-Down menu

When the Display Unit is powered on, you can “swipe” your finger from the top of the screen towards the bottom, to display a Swipe-Down menu (Figure 3-4) with the following items:

Date and Time: The current date and time (12 hour clock). The time needs to be changed in areas that observe daylight-savings-time.

Battery: The battery icon displays the amount of power remaining in the battery.

GPS: Shows which GPS is being used (Internal or External) and the signal strength.

Wi-Fi Network: Indicates if the system is connected to a wireless network and, if so, the name of the network. See [Section 4.1.6](#) for details on connecting the system to a wireless network.

Volume: The Volume + and - buttons are used to increase and decrease speaker volume.

Brightness: The Brightness + and - buttons are used to increase and decrease the screen brightness. For example, increasing the Brightness setting may improve the visibility of the screen in bright sunlight. Note, however, that increasing the screen brightness also increases power consumption, thus reducing battery life.

To close the Swipe-Down menu, touch anywhere on the screen below the swipe-down menu.

4. Tools & Setup

From the main screen shown in Figure 3-2 or Figure 3-3, press **Tools** to enter this sub-menu. Here you can set preferences, adjust system settings, perform system tests and manage files. You will see the screen shown in Figure 4-1:



Figure 4-1: Tools Menu

4.1 Preferences

Selecting the preferences option will take you to the sub-menu shown in Figure 4-2.

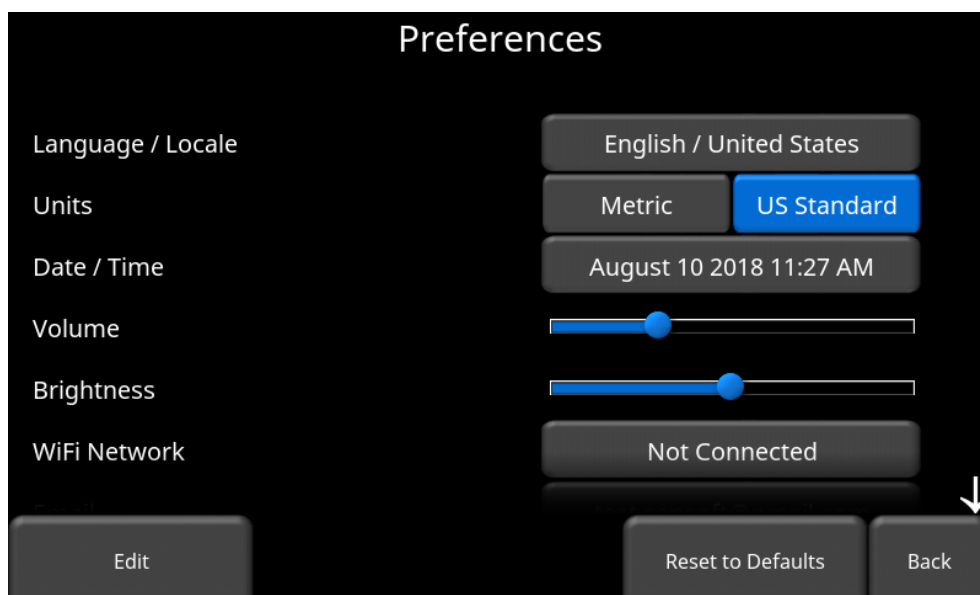

Figure 4-2: Setting Preferences

There are several parameters that can be modified. Touch the screen and swipe up or down to scroll and view additional parameters. To change a value, press the value on the right side of the screen. Alternatively, use the up and down arrows on the 4-way keypad to highlight the desired parameter, then press Edit. Each parameter is described in detail below.

4.1.1 Language / Locale

Selecting this option will display the screen in Figure 4-3. The current language is displayed; pressing the + and – buttons on either side of the language will cycle between the languages currently available. Below that, the Country/Region is displayed. Press the + and – buttons on either side of the displayed Country/Region to alphabetically move to the next or previous country or region.

Alternatively, both Language and Country/Region can be changed by pressing the + and – buttons on the bottom of the screen. Press **Back** when you are done.



Figure 4-3: Changing Language and Country/Region

4.1.2 Units

Pressing **Units** will cycle between US Standard and Metric Units.

4.1.3 Date/Time

Selecting this option takes you to a screen where the date and time can be set. The time is manually set, and will not automatically correct for daylight savings time.

4.1.4 Volume

Scroll bar for adjusting the volume of clicks and beeps heard during operation. This can also be changed by using the Swipe Down menu ([Section 3.4](#)) anytime the system is not collecting data.

4.1.5 Brightness

Scroll bar for adjusting the brightness of the screen. Note that increasing the brightness consumes more battery power. This can also be changed by using the Swipe Down menu ([Section 3.4](#)) anytime the system is not collecting data.

4.1.6 Wi-Fi Network

Connecting to a wireless network allows you to send a mini-report to someone by e-mail. This connection can be through a standard Wi-Fi network or through a hotspot on your mobile device while in the field.

Note that LMX200 CANNOT connect to Public Hotspots (typically restaurants, hotels and airports) that require a web-based login and acceptance of their Terms & Conditions. It also CANNOT connect to unsecured networks (networks that do not require a password).

If you are already connected to a Wi-Fi network, the name of the network is listed beside the Wi-Fi Network field. Selecting **Wi-Fi Settings** takes you to a sub-menu (Figure 4-4) for connecting and configuring Wi-Fi settings.

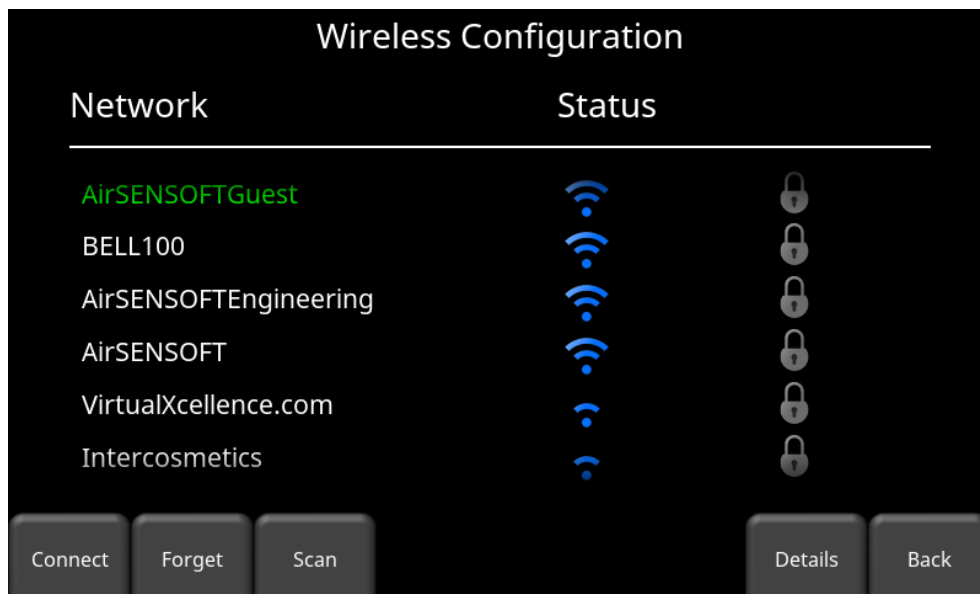

Figure 4-4: Configuring Wireless settings and E-mail address

Use the 4-way directional arrows or touchscreen to select the network. The color of the Network Name indicates the status:

- Green = Connected
- Yellow = Not currently connected, but remembered from before when you previously connected and entered a password.
- White = Not connected

- **Connect** – Select the desired network and press Connect. If the connection is successful (this can take a minute or so) a screen appears asking for the password for that network. If the network name is yellow (from a previous connection to this network), it will not ask for a password because it is a remembered network. Once it connects the Network Name will turn green.
- **Forget** – Use the Forget button to remove the password for connected or remembered networks (text in green or yellow). Once the ‘forget’ button is pressed on a selected network it will remove the password and the Network Name will turn white. You will also be disconnected if you are currently connected to that network.
- **Scan** – Scans for any available networks in the area and displays them in order of strength of signal. You may need to press this button a second time if you don’t see the network you are looking for.
- **Details** – Pressing this button displays the security settings and device addresses related to the selected network.
- **Back** – Press this button to return to the System Settings screen.

4.1.7 Email

Press **E-mail** to arrive at a sub-menu where you can setup and configure a sending e-mail address. Ensure that this e-mail address already exists. This is the sending account where messages will originate from. All mini-reports received by the recipient will appear to come from this account.

Using GMAIL

The system is already pre-configured to use GMAIL as the e-mail provider for the sending account (Figure 4-5):

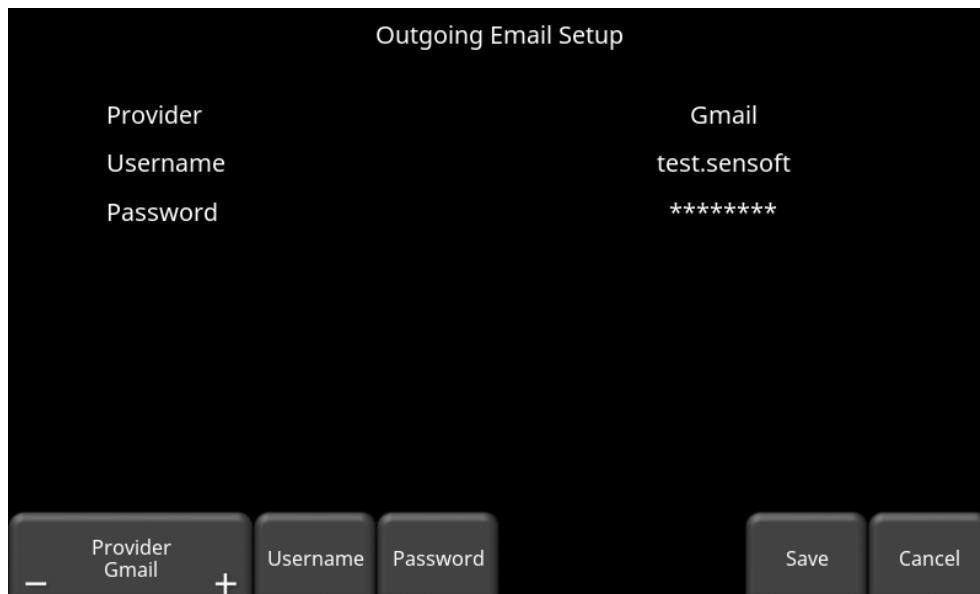

Figure 4-5: Using GMAIL as e-mail provider

- Press **Username** to display a keyboard where you can enter your GMAIL user name only; you do **not** need to enter @gmail.com. Then press OK when done (Figure 4-6a)
- Press **Password** to display a keyboard where you can enter your GMAIL password. Then press OK when done (Figure 4-6b)
- Press **Save** when both Username and Password have been entered.

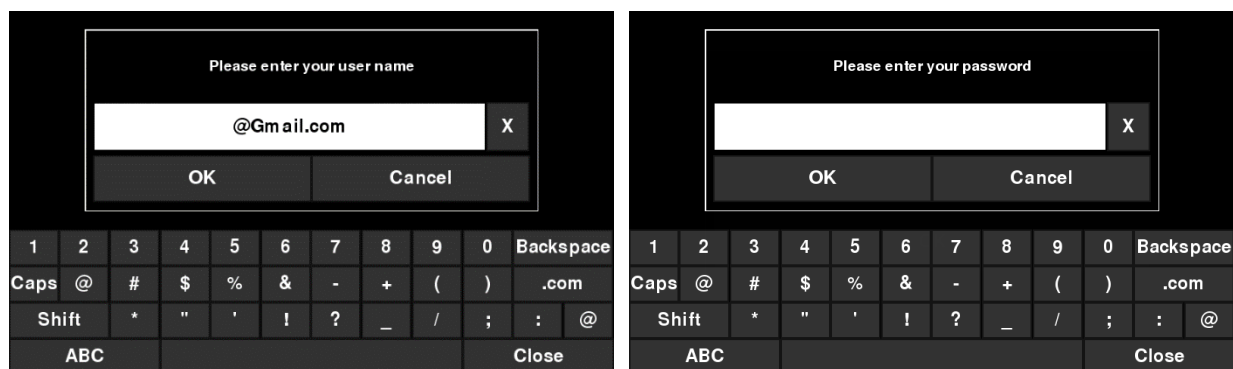

Figure 4-6: Entering e-mail address (a) and password (b) for GMAIL

If there are no warning messages, the e-mail address is setup properly and you are ready to e-mail mini-reports from the field. If this does not work, see the [Failed Setup](#) section below

Using Another Provider

Note: It is highly recommended to use a GMAIL account as the system is pre-configured for this. If you choose to use another provider, you will have to contact that provider if you have any issues with the settings.

To use another e-mail provider, press the **+** and **-** buttons under **Provider** until it says **Custom**. This will display the screen shown in Figure 4-7 allowing you to setup and configure a different e-mail provider:

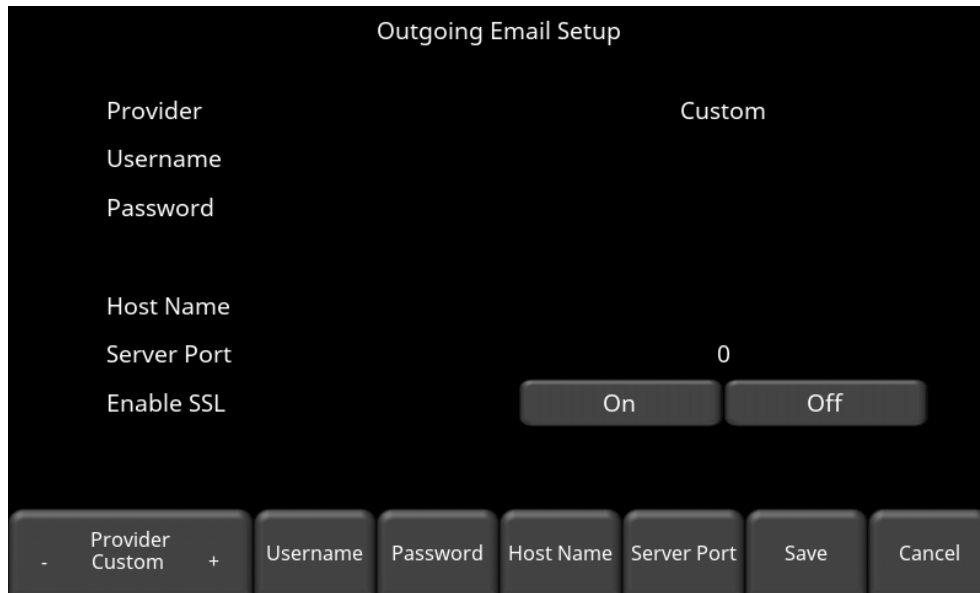

Figure 4-7: Entering e-mail address and password for another e-mail provider

- Press **Username** to display a keyboard where you can enter the complete e-mail address, then press OK when done.
- Press **Password** to display a keyboard where you can enter the password, then press OK when done.
- Press **Host Name** to display a keyboard where you can enter the name of the server address handling the outgoing mail. See chart below for some common e-mail providers. If your provider is not listed, it can usually be found by searching online for “SMTP host name <provider>”, where provider is the host name e.g. Yahoo or AOL. Press OK when done.
- Press **Server Port** to display a keyboard where you can enter the port number used by the email server. Searching online for host name will usually provide the port number for that e-mail provider. In most cases, it’s usually 465 (if SSL is enabled, see next bullet point), or 587. See chart below for some examples. Press OK when done.
- Enable SSL – you can select **On** or **Off** on the display. SSL provides encryption security. Some e-mail providers require this set to ON. This will usually be indicated on the same online search page that was used above. See the chart below for examples.
- Press **Save** when all the information is entered and correct.

Below is the chart for some common e-mail providers:

Provider	Host name	Server Port	Enable SSL
Yahoo	smtp.mail.yahoo.com	465	On
Hotmail/Outlook	smtp.live.com	587	Off
iCloud	smtp.mail.me.com	587	Off
163.com	smtp.163.com	465	On
Yandex	smtp.yandex.com	465	On

If there are no warning messages, the e-mail address is setup properly and you are ready to e-mail mini-reports from the field.

Failed Setup

If setup failed, possible reasons include:

1. Email address or password was entered incorrectly – try re-entering these fields.
2. Hostname, port or SSL setting are incorrect
3. Your email security settings **may need** to be adjusted, which may require you to login to your e-mail account from a PC or mobile device. An example of the GMAIL security settings is shown below (current as of writing this manual). For other e-mail providers, you may need to modify the settings accordingly.

To edit the GMAIL security settings, visit <https://myaccount.google.com/> and sign into your account. You will then see the screen below. Click on Connected apps & sites

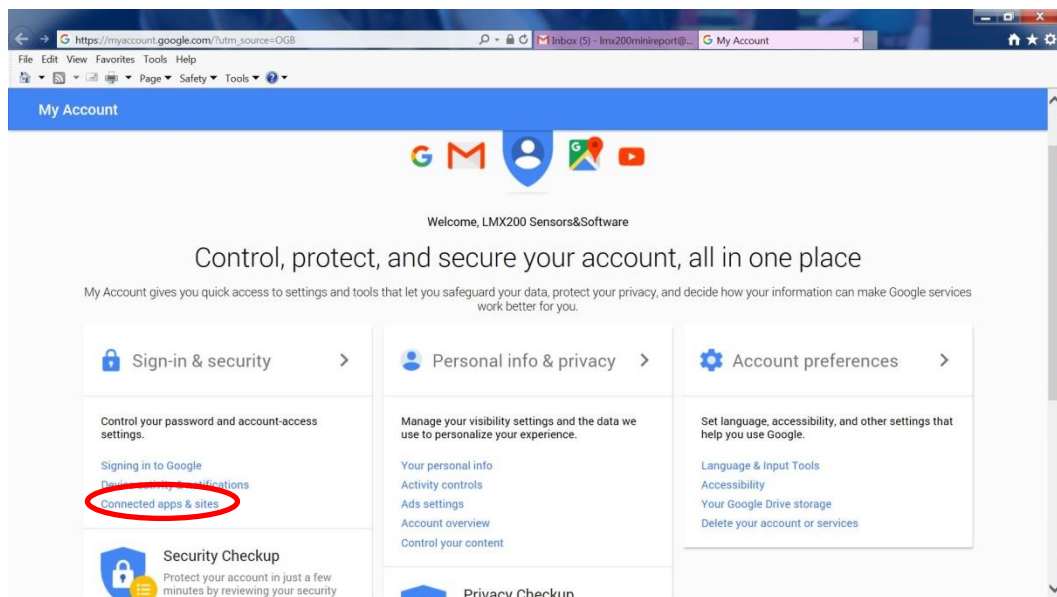

On the page that follows, ensure the setting “Allow less secure apps” is set to ON

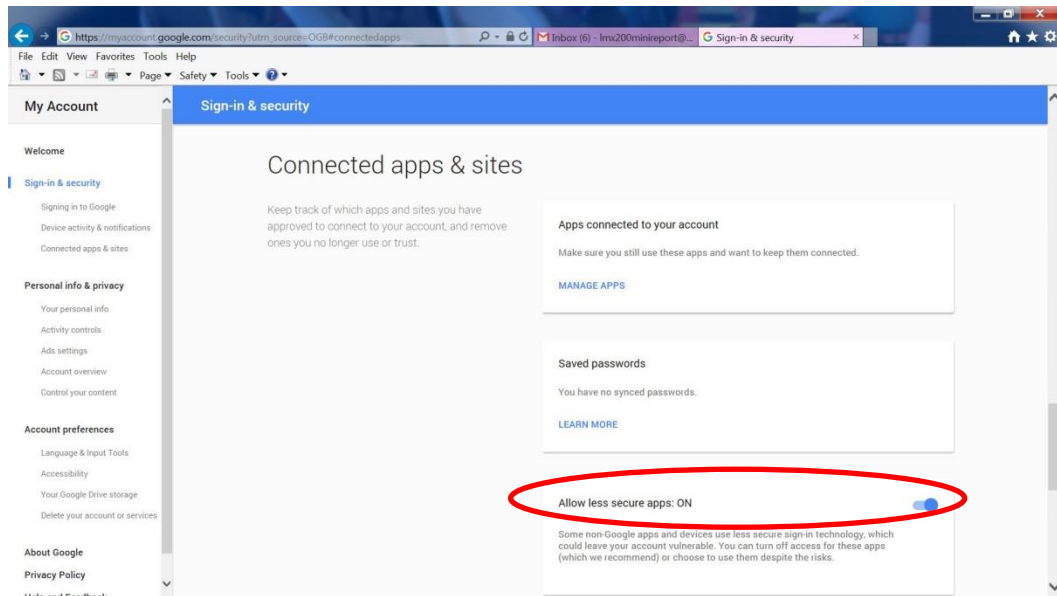

4.1.8 Screen Saver

A screen saver can be setup to turn off the Display Unit screen after a period of inactivity to save power. The Screen Saver can be set to turn the screen off after 1 minute, 5 minutes or never (OFF setting). Pressing this button cycles between those three options. When the screensaver is activated and the screen shuts off, touch anywhere on the screen to turn it back on again.

4.1.9 GPR Plot Options

Selecting this option will display the screen in Figure 4-8.



Figure 4-8: GPR Line Plot Options

- Auto-Hide Buttons** - If this is set to ON, then in Line Scan mode, the buttons at the bottom of the screen disappear shortly after data collection begins, effectively enlarging the area for data display. The buttons will re-appear after a couple of seconds whenever the sensor stops moving forward, is in back-up mode or any button is pressed on the keypad.

4.1.10 Reset to Defaults

Selecting this option at the bottom of the screen will reset all settings & preferences back to the default settings (Figure 4-9). Pressing this will ask you to confirm the Reset to Defaults. If **Yes** is selected, the next screen will ask if you would like to remove all saved wireless networks and e-mails addresses.

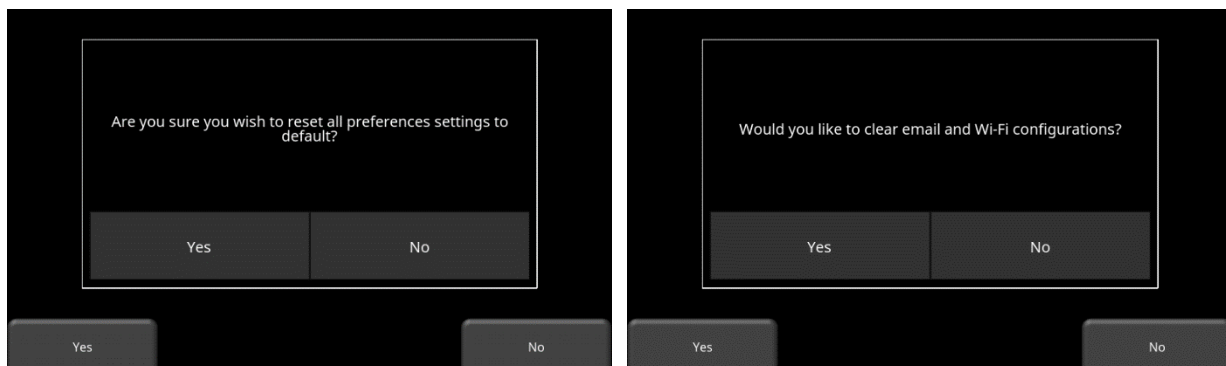

Figure 4-9: Reset to Defaults, a) Image on left is the first confirmation screen. b) If you press Yes, you will see the second confirmation screen on the right asking about deleting e-mails and Wi-Fi settings.

4.2 System Test

The System Test sub-menu (Figure 4-10) allows the user to perform certain tests to ensure proper operation of the system. Select the component to test then press **Start**. After completing a test there is an indication of whether the system passed or failed the test. Each test is described below in more detail.

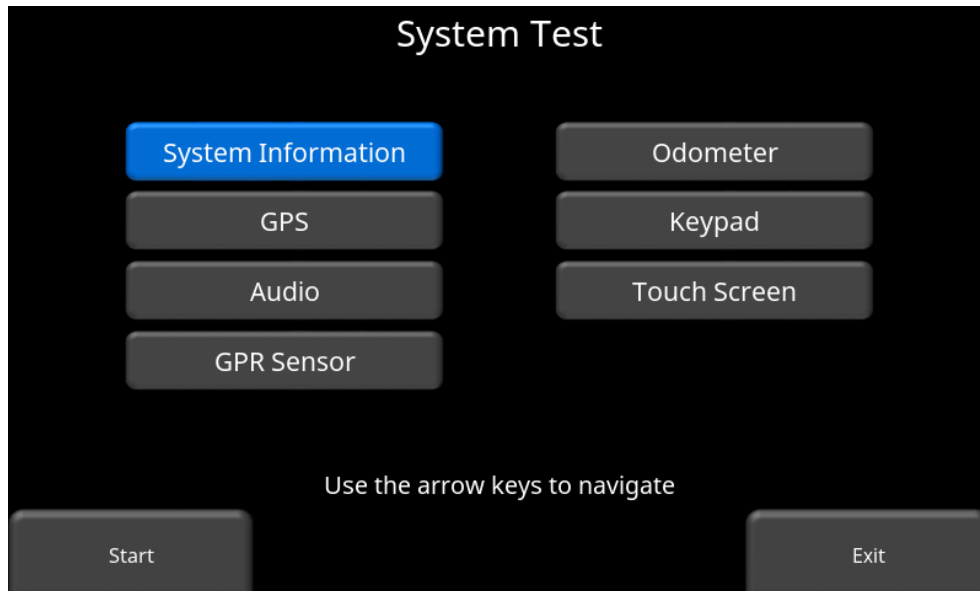

Figure 4-10: System Test menu

4.2.1 System Information

System Information is the only option in System Test which is not actually a test. Here information such as the version, serial numbers, temperature and battery power are displayed. (Figure 4-11). There are two options at the bottom of this screen:

- **Export** - If a USB key is currently inserted, pressing Export will just export the System Log and Summary Files

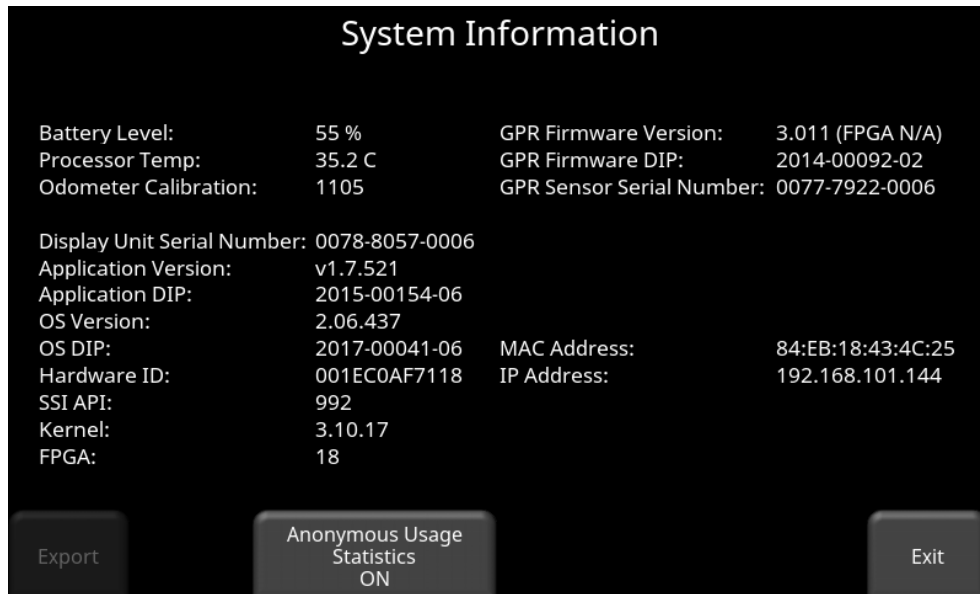

Figure 4-11: System Information

- Anonymous Usage Statistics** - When this is set to ON and the user is connected to a wireless network, any system malfunctions will trigger an automatic notification to Sensors & Software. This is to help with gathering information about any system irregularities. As the name suggests, the notification is completely anonymous and no personal information is sent.

4.2.2 Keypad Test

The keypad test ensures that all buttons on the membrane keypad are working. Press **Start** to begin the test which requires the user to press each button once, within a 20 second timeframe (Figure 4-12).

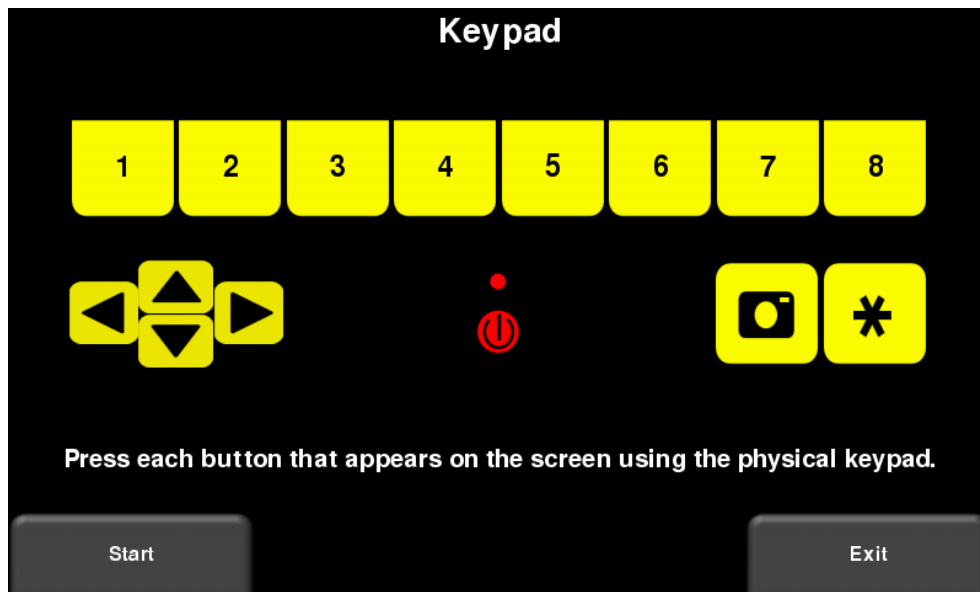

Figure 4-12: Keypad Test

Once that is complete, a short LED test will ensue, which checks the proper operation of the LED.

4.2.3 Audio

This test ensures that the speaking is operating properly. After starting the test, you should hear a sound with an increasing pitch.

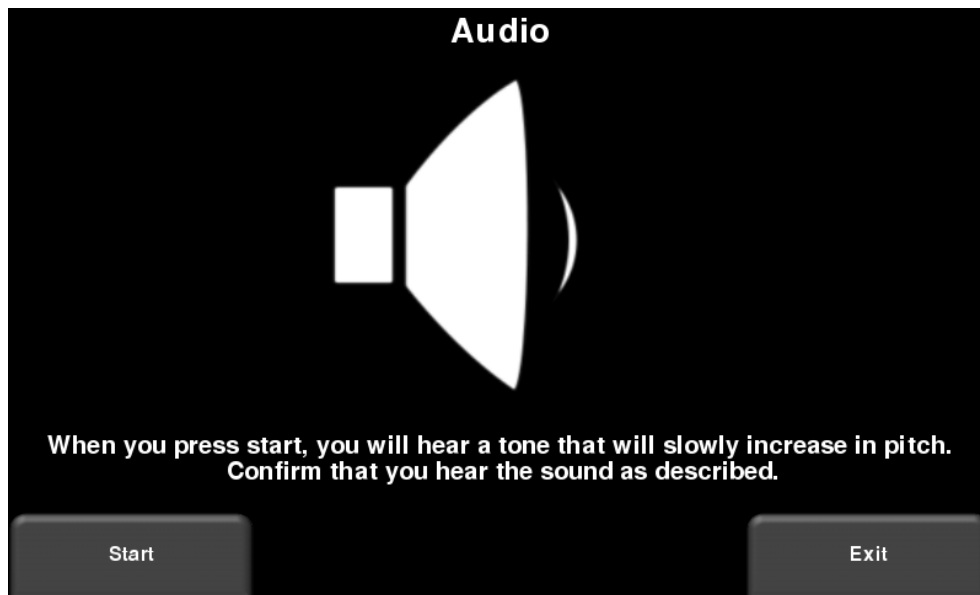

Figure 4-13: Audio Test

4.2.4 Touch Screen

The test checks proper operation of the touch screen (Figure 4-14). It allows you to test the screen (by pressing **Test**) or perform a quick calibration followed by a test (by pressing **Calibrate**). Both involve touching targets on the screen in the allotted time.

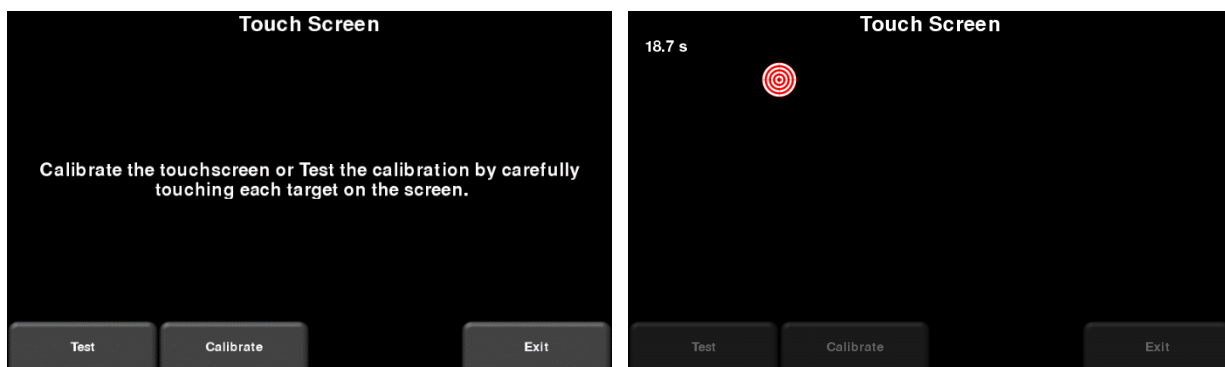

Figure 4-14: Touch Screen test on the left, Touch Screen calibration test on the right

4.2.5 Sensor Test

This test checks proper operation of the GPR sensor, including the amplitude of the pulse. Once the cart is tipped backwards and start is pressed, it will conduct the test (Figure 4-15). If there are any irregularities, the test will indicate failure.

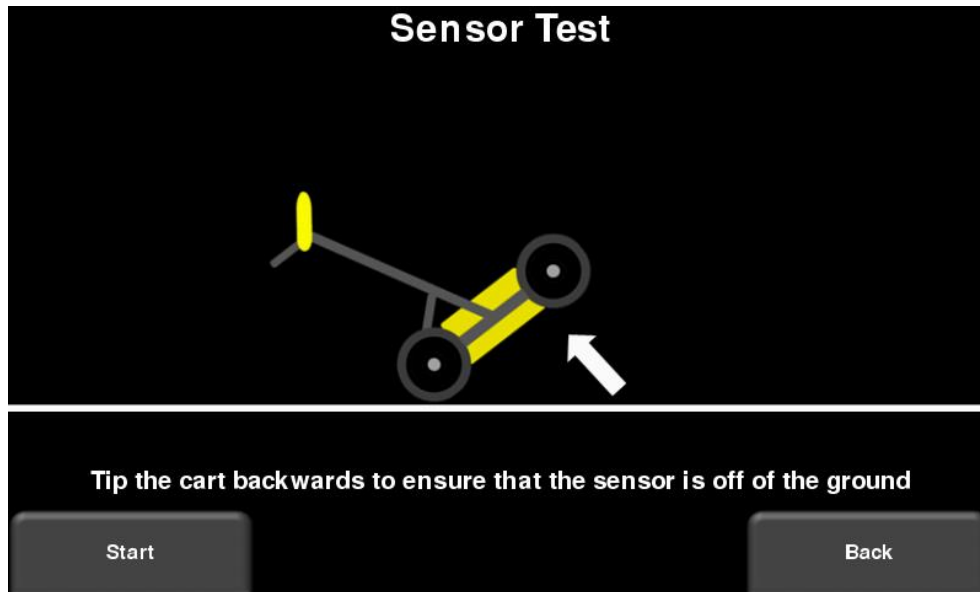

Figure 4-15: Sensor Test

4.2.6 Odometer Calibration

This test ensures that the odometer is measuring distance accurately. Even though the odometer is calibrated in the factory, you must calibrate it periodically to ensure accuracy. This is particularly important as the calibration can change with different surface materials.

When selecting this option, you will see the screen in Figure 4-16. The following options exist:

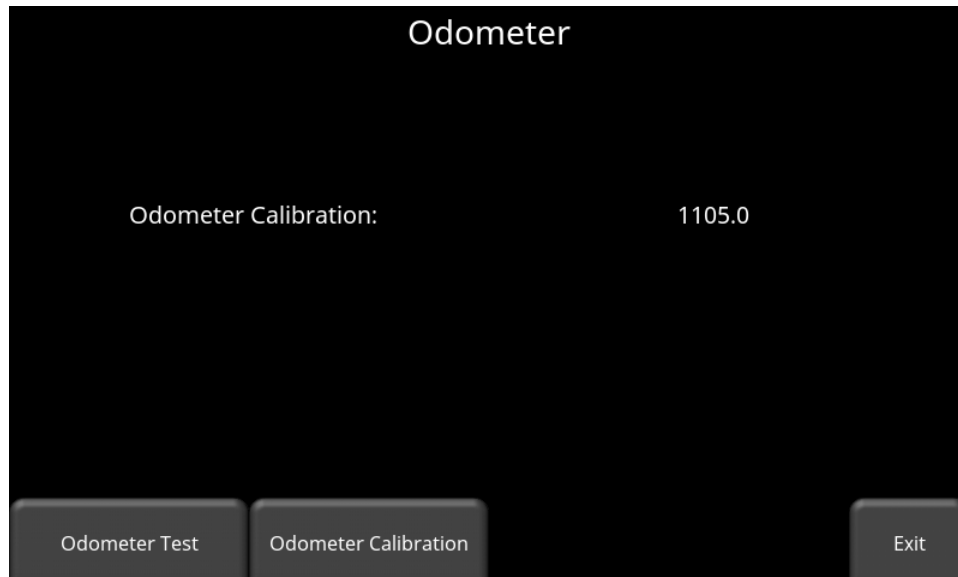

Figure 4-16: Screen displaying current odometer calibration

- **Odometer Test** – This test verifies the odometer is calibrated properly. It involves moving the system a set distance (5m or 10', depending on units used), and comparing the value obtained to a known value. The screen in Figure 4-17 will be displayed once Odometer Test is pressed. Press **Start** to begin and then press **Finish** when you've moved that distance. It will display a pass or fail, along with a percentage difference from the known value (Figure 4-18).

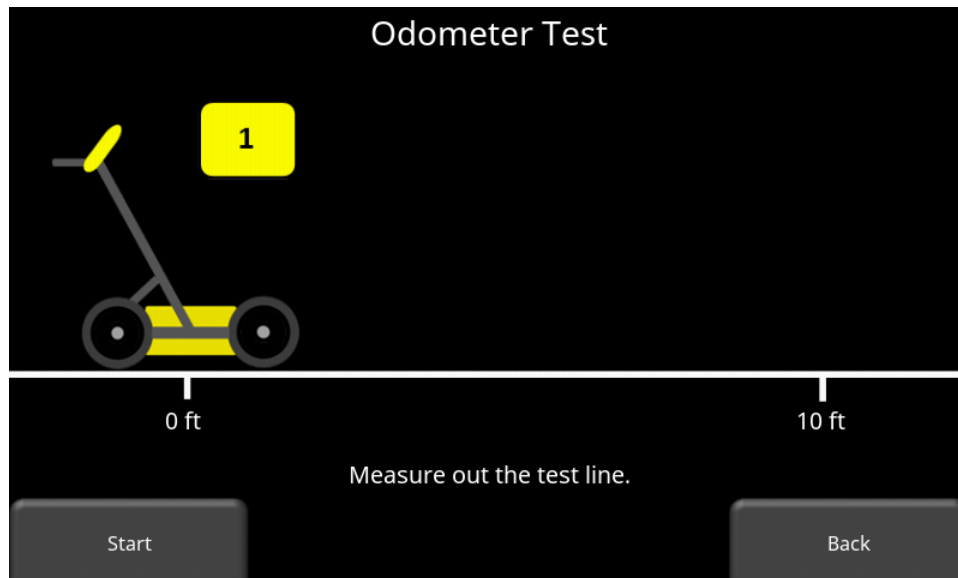

Figure 4-17: Doing an odometer test

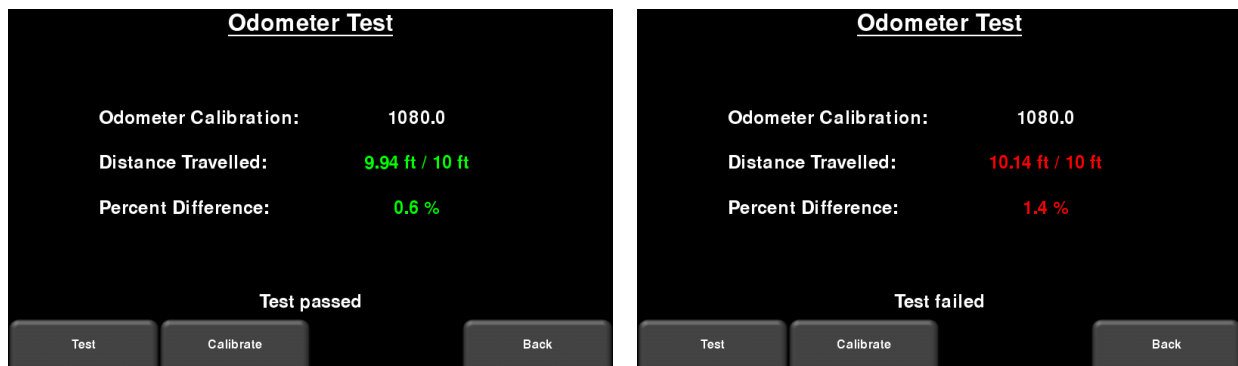

Figure 4-18: Odometer Test passed on left, failed on the right

- Odometer Calibration** - This option actually calibrates the odometer (Figure 4-19). Choose a set distance from the screen, or select Custom. Then press **Start** and move the system that exact distance, using a measuring tape or other known distance indicator. Press **Finish** when you have travelled that distance

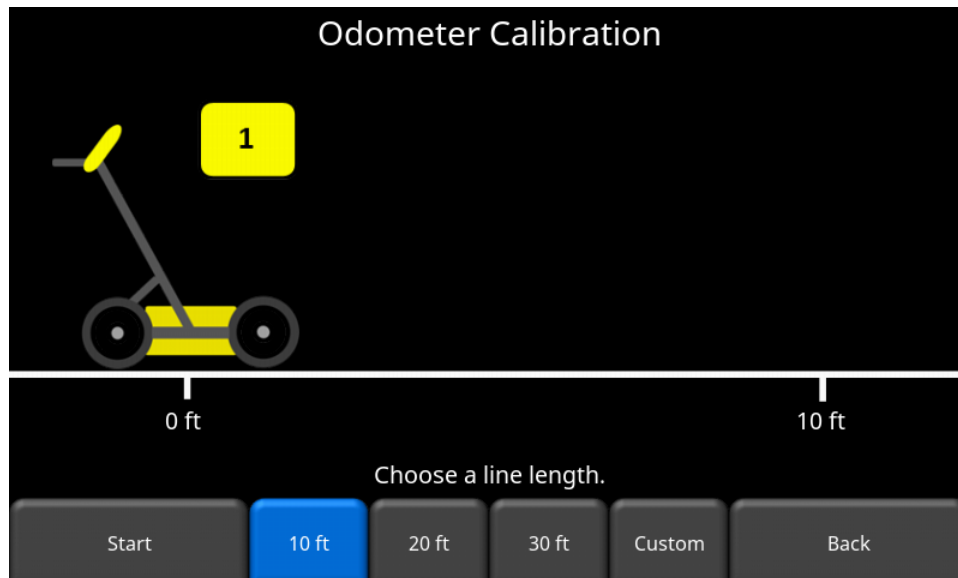

Figure 4-19: Odometer Calibration – select a distance and then press Start

Upon completion, it displays the screen in Figure 4-20 (left image). You can either accept the new value by pressing Accept, or revert back to the previous value by pressing Reject. If the new value is significantly out of range, the test will fail Figure 4-20 (right image).

The odometer calibration value is stored in the Display Unit. If the Display Unit is changed, or swapped out, you will need to run the Odometer Calibration test again.

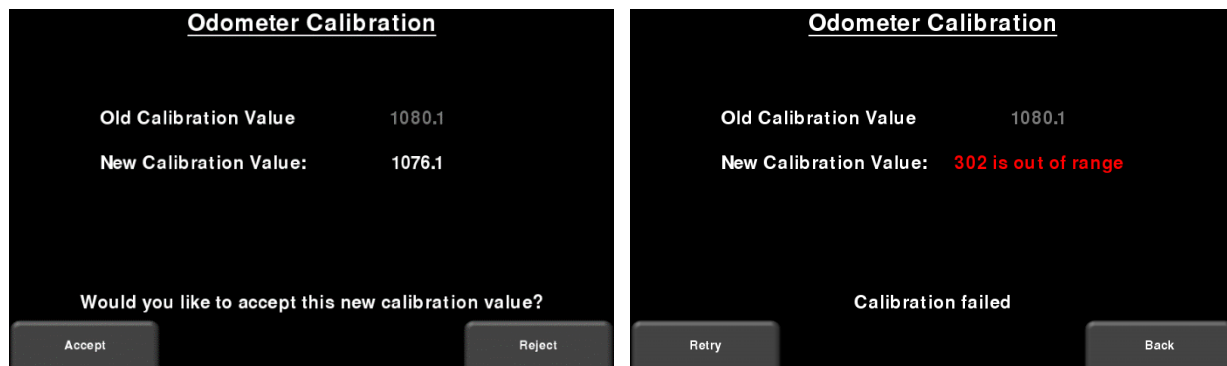

Figure 4-20: Results of successful Odometer Calibration (Left). Image on Right shows a failure, as calibration is out of range

4.2.7 GPS

The GPS test will ensure that the system is communicating properly with the GPS and receiving data (Figure 4-21).



Figure 4-21: GPS Test

The basic position and time information is displayed on the screen. On the screen, the Fix Type notes if there are any corrections being applied, such as DGPS.

Pressing **Strings** will display the raw data strings that are outputted by the GPS (Figure 4-22) as they scroll down the screen. The user may select this option to verify the GPS is outputting the proper NMEA string format.



Figure 4-22: GPS Strings

Pressing **Clear** will clear the strings. Pressing **Info** will return to the main GPS test menu.

Press **GPS Setup** to see the screen in Figure 4-23.

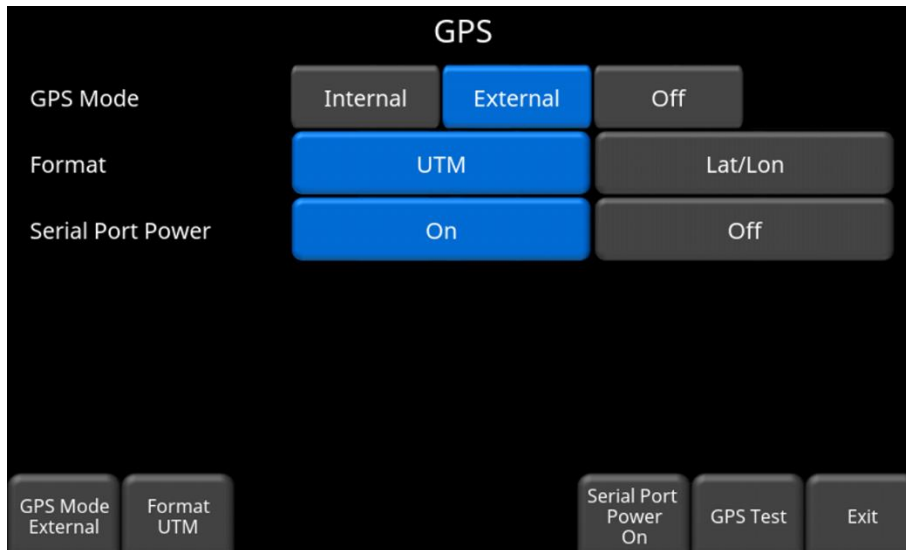

Figure 4-23: GPS Setup screen

The following buttons are explained below:

- **GPS Mode** –you can select whether to use the internal GPS, external GPS or no GPS at all (Off)
- **Format** – GPS units can be either UTM (Universal Transverse Mercator) or Latitude/Longitude coordinates
- **GPS Test** – pressing this will return to the screen in Figure 4-21
- **Serial Port Power** - the serial port on the back of the Display Unit can output power, thereby enabling a single cable to be used for the GPS (power and data). When you purchase the GPS from Sensors & Software, this cable is included. However, if you use a 3rd party GPS, you need to determine if the GPS can accept power via the serial port. Check the pin-out diagram in [Section 2.2](#).

Pressing the **On** button will turn power to the serial port on, but it will display a warning message first Figure 4-24. Press **Off** to disable power to the serial port.

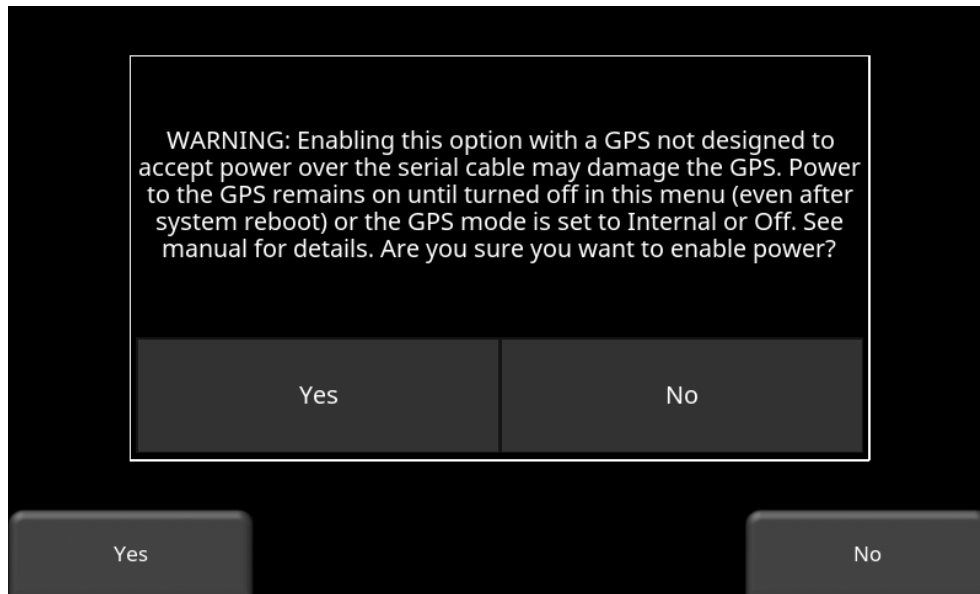

Figure 4-24: Warning message about enabling power to the serial port

4.3 File Management

Press **File Management** to enter this sub-menu. From here, the user can view screenshots, export data and delete all data. If you have the regular LMX200, you will see the image in Figure 4-25a. If you have the LMX200 Enhanced system, you will see the image in Figure 4-25b.

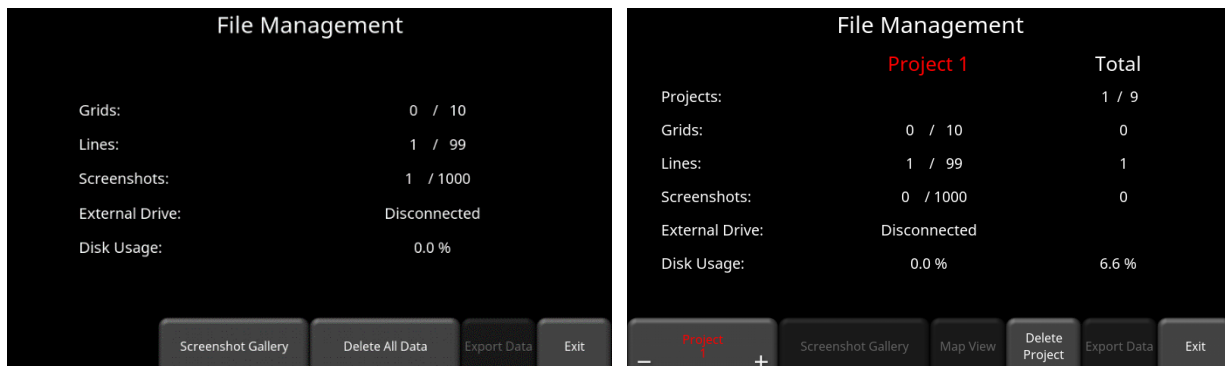

Figure 4-25: a) LMX200 system on left, displays the total number of lines, grids and screenshots saved on the system. b) The LMX200 Enhanced system on the right displays the lines, grids and screenshots for a given project in the middle column. The right column displays the total for each that are saved on the system.

A description of each of the buttons is given below:

4.3.1 Screenshot Gallery

This allows the user to view all screenshots that were saved by pressing the Camera button ([Section 10.1](#)). The display will show a Tile View of four screenshots per page (Figure 4-26). If

there are more than four screenshots, swipe the screen from right to left to view the rest. Alternatively, you can also use the **Left** and **Right** arrow keys on the 4-way directional keypad

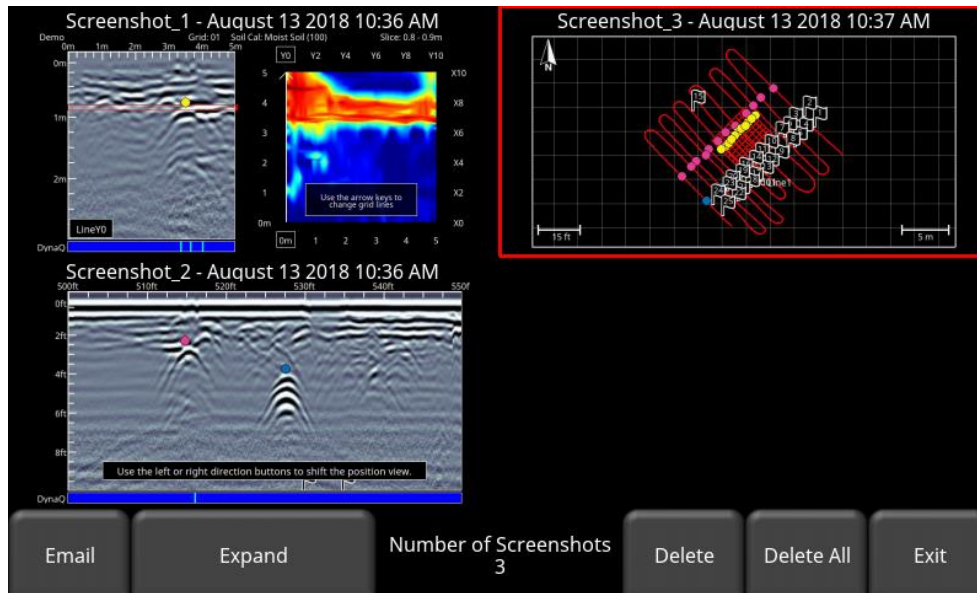

Figure 4-26: Tile View in Screenshot Gallery

From the Tile View, the user has the following options:

- **E-mail** – pressing this button will e-mail the selected screenshot (provided you are connected to a wireless network and have setup an account to send from). You will be prompted to enter a destination e-mail address, or you may use the most recent one which will be listed by default. Pressing the “...” button to the left of the e-mail address displays the last 5 e-mail addresses used, allowing the user to easily select a recently used email address, rather than re-entering it.
- **Expand** – press this button to show the selected screenshot as a full screen image. On the subsequent screen, press **Tile View** to return to the screen displaying four screenshots per page.
- **Delete** – pressing this button will delete the displayed screenshot. There will be a confirmation message asking if you are sure. Press **Yes** to proceed.
- **Delete All** – pressing this button will delete all screenshots. There will be a confirmation message asking if you are sure. Press **Yes** to proceed.

4.3.2 Delete All Data

Pressing this will delete all data saved on the system. There is a confirmation window asking if you are sure; press Yes to continue deleting, press No to cancel.

4.3.3 Delete Project (Enhanced system)

Pressing this will delete the currently selected project. There is a confirmation window asking if you are sure; press Yes to continue deleting, press No to cancel.

4.3.4 Export Data

Screenshots and data are always saved to the internal memory of the Display Unit. If a USB-drive (memory stick) is inserted into the USB port on the Display Unit, the Export Data button will be available (otherwise it will be greyed-out).

In the LMX200, pressing the **Export Data** button will copy all the data files to the USB drive. In the LMX200 Enhanced, pressing the **Export Data** button will copy all the data files in that particular Project to the USB drive.

5 GPR Concepts

5.1 Theory

Ground penetrating radar (GPR) technology uses radio waves to image objects in the subsurface. The subsurface may consist of soil, rock, asphalt and other materials. GPR systems emit high frequency radio wave pulses and detect the echoes that return from objects within the subsurface. Echoes are produced when the target material is different from the host material (e.g. PVC pipe in gravel)

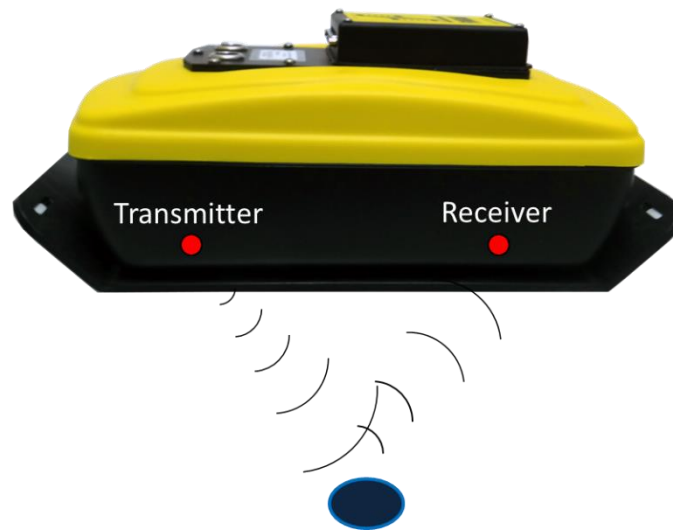

5.2 Hyperbolas

The GPR display shows signal amplitude versus depth (time) and sensor position along a line. This is called a “Line Scan”. Since radar energy radiates in a 3D cone shape rather than a thin beam, a **hyperbola** (or inverted U) is the GPR response from a small point target like a pipe, rock, or a tree root. The radar wave hits the object before and after going over it and forms a hyperbolic reflection that can appear on the record even though the object is not directly below the radar:

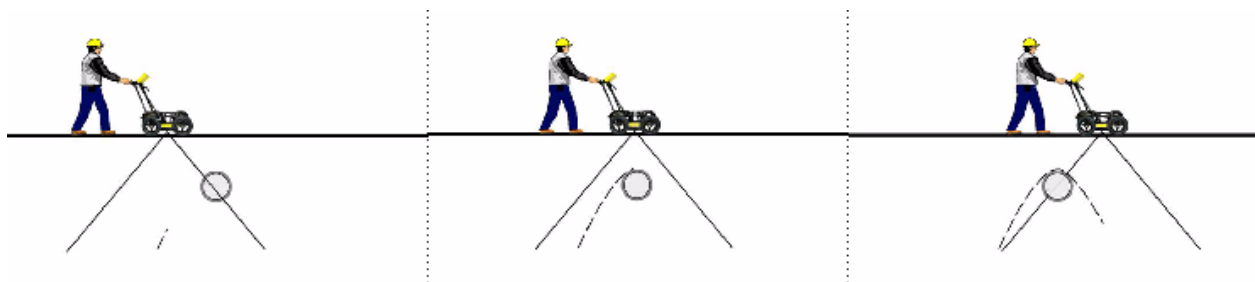

Hyperbolas are best viewed when subsurface targets are crossed perpendicularly (at a 90 degree angle). The actual position of the object is located at the apex of the hyperbola.

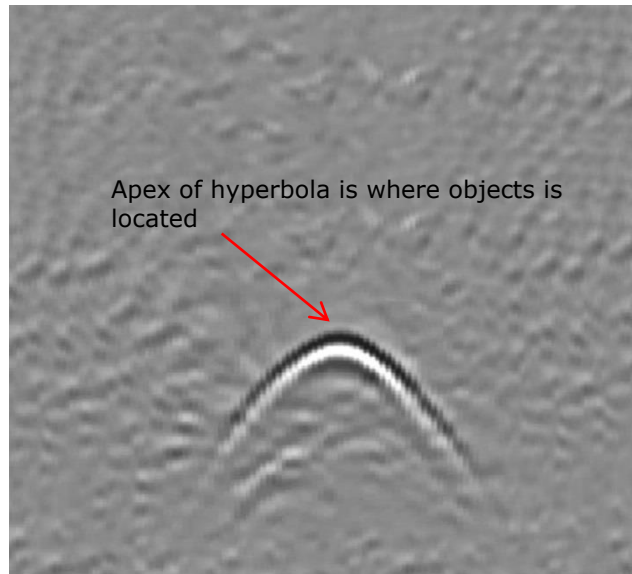

5.3 Calculating Depth

Ground penetrating radar records the time it takes a radio wave to travel to a target and back; it does not measure the depth to that target directly. Depth to target is calculated based on the velocity with which the wave travels to the target and back.

To calculate depth:

$$D = V \times T/2$$

Where D is Depth

V is Velocity

T is the Two – way travel time

For the LMX200, velocity is indicated by the Soil Calibration Value, known as Soil Cal. Once the Soil Cal values are set, the measured depths will be determined accurately ([Section 6.7.6](#))

5.4 Soil Calibration values

Below is a table of common subsurface materials and their corresponding Soil Cal. This is only a guideline and there is some variation based on the fact that there can be a mixture of different materials in the subsurface. By far, the soil water content has the biggest influence on Soil Cal values.

Material	Soil Cal
Air	300
Ice	160
Dry Soil	140
Dry Rock	120
Soil	100
Wet Rock	100
Concrete	100
Pavement	100
Wet Soil	65
Water	33

5.5 Air Waves

Some hyperbolas are caused by air wave reflections from objects above ground, such as posts, fences, overhead wires, and trees.

The following image displays how air wave reflections affect data:

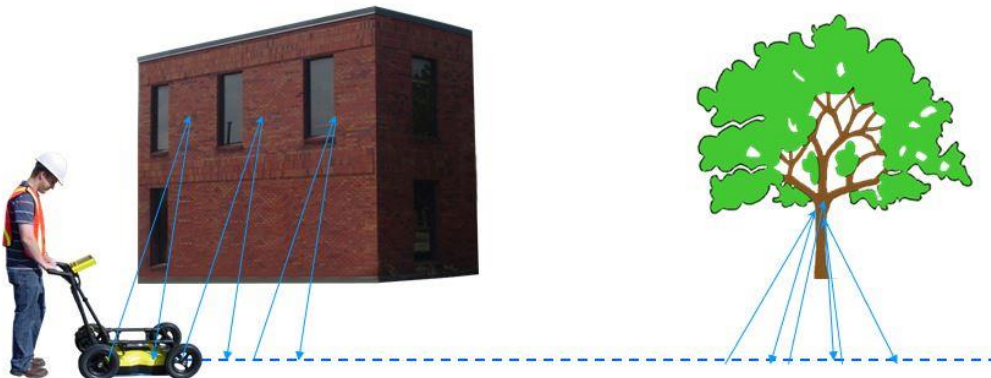

An important part of understanding the data image is learning to recognize these unwanted "air" targets and distinguish them from the targets in the ground. Good field notes are indispensable for helping identify unwanted events on the data.

The best way to identify air reflections is the target hyperbola method. Hyperbolas from above ground objects are wider than objects in the ground and will have a Soil Cal at, or close to, 300.

To learn more, see Soil Cal ([Section 6.7.6](#)).

6 Line Scan

Line Scan mode allows the operator to acquire data along a straight line and examine it as a cross-section image. The operator can locate a feature and easily back-up and mark the location of that object on the ground. Line Scan mode can be used to identify the alignment of subsurface features, check for linearity and acquire accurate depth measurements.

If you have the LMX200 Enhanced, ensure you are in the appropriate project before entering this mode.

From the main screen, press the **Line Scan** button; you will see the screen shown in Figure 6-1.

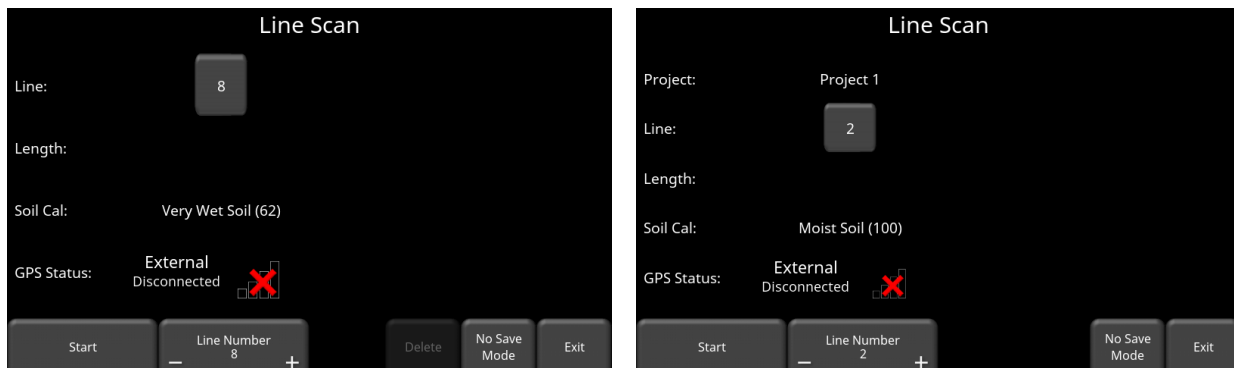

Figure 6-1: (a) LMX200 on left, (b) LMX200 Enhanced on right. The LMX200 has the MapView option on this screen.

The GPS Status indicates which GPS is currently selected, as well as the quality of the GPS signal, which is based on the number of satellites that it sees. The chart below explains what the colours and bars mean:

Indicator Color	# of bars	# of Satellites
Red	1	4
Orange	2	5
Green	3	6,7
Green	4	8,9
Green	5	10+

6.1 Selecting a line

To select the desired line, press the **+** and **-** buttons under **Line Number** on the bottom of the screen. Alternatively, pressing the line number button itself will show the screen in Figure 6-3. From here, you can go directly to any line number. If the line number is white, then that line is empty, whereas lines that already contain data are shown in red.

To collect data without saving it, press **No Save Mode**. Any data collected will NOT be saved, but screen shots can still be taken with the **Camera** button. These screen shots get placed in the currently selected project. Two features that are only available in No Save Mode (the Pause button and the ability to draw arrows) are described in [Section 6.7.8](#) and [Section 6.7.9](#) respectively.

If the line number is white (Figure 6-1), Press **Start** to enter data acquisition. All data collected will be saved under this line number.

If the line number is shown in red (Figure 6-2), you will see the data preview on the right side of the screen. If it's a long line, only the last part of the data will be shown. From this screen, you will have the following options available:

- **View** – press this button to load the currently displayed line. Longer lines will take a few extra seconds to load.
- **Delete** – pressing this will delete the line. It will prompt you to confirm before deleting.

When using the LMX200, there is a MapView button at the bottom of the Line Scan screen. The details of the MapView button are explained in [Section 9](#).

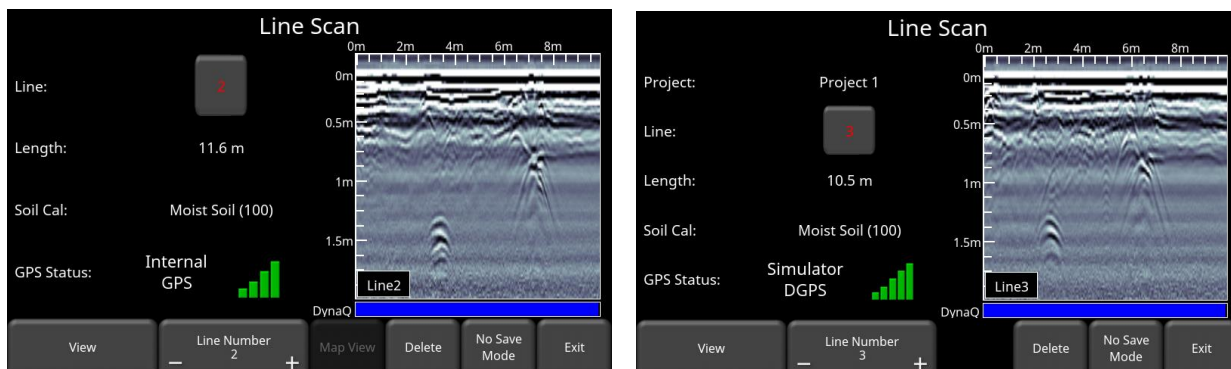

Figure 6-2: Line Scan mode, showing a line that was previously collected (a) LMX200 on left, (b) LMX200 Enhanced on right. The LMX200 has the MapView option on this screen.

Select a line number:

X

OK
Cancel

1	2	3	0	Clear
4	5	6	.	Del
7	8	9	- / +	Close

Figure 6-3: When the button showing the line number is pressed, this screen allows the user to directly input the line they wish to go to

6.2 Acquiring Data

Press the **Start** button to begin collecting data. The screen will change to the data acquisition screen. As the system is pushed along a straight line, the collected GPR data scrolls onto the screen from the right and moves to the left (Figure 6-4).

The depth scale along the side of the GPR Line image and the position scale along the top of the image are set to Metric or US Standard units based on the setting in the Preferences menu ([Section 4.1](#))

A single line cannot be longer than 1000m or 3000 ft. You will receive a warning about line length just before it hits that limit. If you continue to that limit, data collection will automatically be stopped and the line will be saved.

If Auto-Hide Buttons is set to ON ([Section 4.1.9](#)), the menu at the bottom of the screen disappears as soon as you start collecting new data, thereby maximizing the data display area. When the user stops, backs up or presses a button on the keypad the menu reappears.

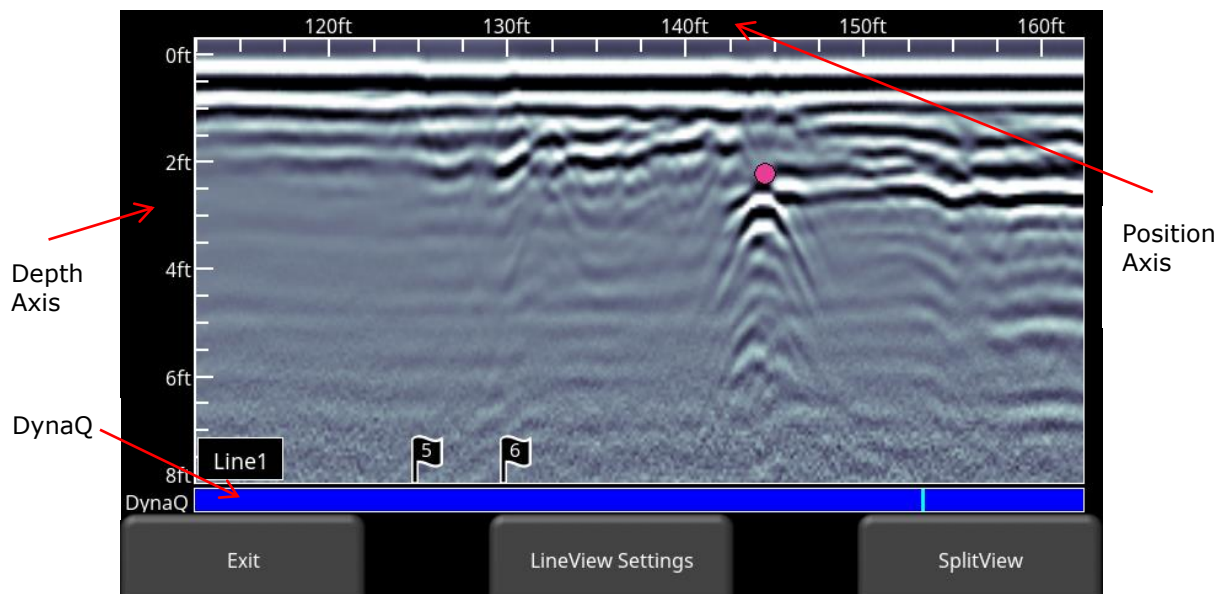

Figure 6-4: Line Scan acquisition mode, showing collected data and axis labels. DynaQ indicator is shown at the bottom above the menu options.

6.3 DynaQ

The LMX200 uses DynaQ, an advanced patented technology that adjusts data quality as the system movement speed varies. In most situations, moving the system at a comfortable walking speed generates data of good quality. In situations where target resolution or maximum penetration depth is critical, moving slower increases data quality.

As the Line Scan data scrolls on the screen, the DynaQ Index Bar is displayed along the bottom of the screen (Figure 6-4). The color of the bar indicates the quality of the data at that point along the line:

White	= No Data (too fast!)
Yellow	= Moderate quality
Light blue	= Better quality
Dark Blue	= Highest quality

In general, avoid collecting data at extremely high speeds.

6.4 Back-up Indicator

Line Scan mode incorporates a back-up feature to enable you to accurately locate targets and mark them on the ground. After acquiring some data on the screen, move the system backwards (Figure 6-5a). During back-up mode, there will be two indicators:

- **Position Indicator:** The red vertical line corresponds to the location at the center of the GPR sensor. As you pull the cart backwards, the Position Indicator moves to mark the current location of the cart in the image and a box appears with the current position, relative to the start of the line, listed as the top number.

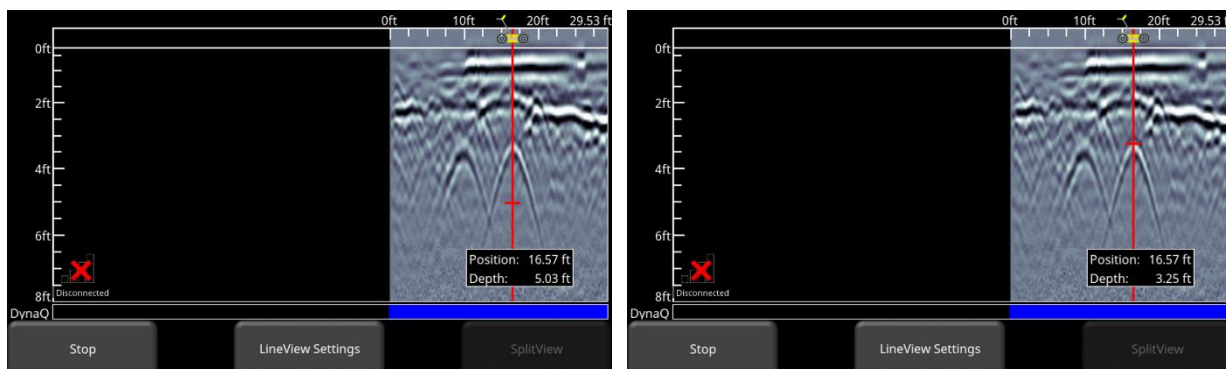

Figure 6-5: a) Back-up Indicator, b) Moving the Depth Indicator to the top of the hyperbola

- **Depth Indicator:** A short red horizontal line corresponds to the current depth value, as shown in the bottom number in the box. To determine the depth of an object, move the indicator up or down by dragging the horizontal line to the desired location (Figure 6-5b). Alternatively, you can also use the **Up** and **Down** arrows on the 4-way directional keypad. Note: make sure you have done a Soil Cal to ensure depth accuracy ([Section 6.7.6](#)).

To locate a feature, simply roll the system back along the same path until the red vertical line is exactly over the response (usually a hyperbola). You can mark the location of the object on the

surface and continue data collection. Once you reach the point where you initially started backing-up, the system will continue acquiring new data.

You can also obtain depth and position information anywhere on the Line Scan by touching the screen, holding for a second, then releasing. A cross-hair appears where you touched the screen, with a box displaying the position and depth (Figure 6-6). To get the position and depth information about a different point on the screen, simply touch and drag the box or cross-hair to the desired position.

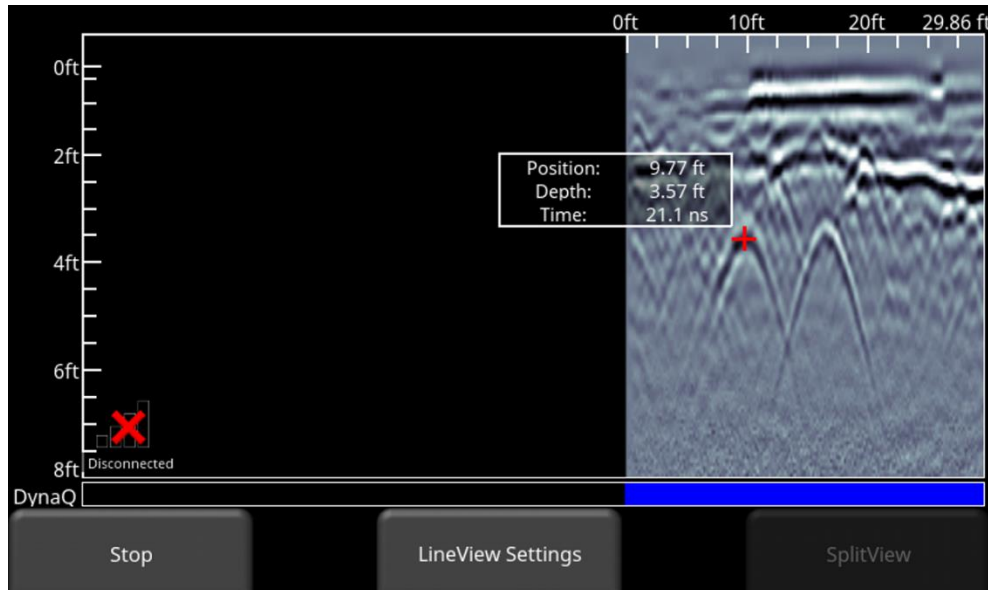

Figure 6-6: Touch screen to get depth and horizontal position at any point

Pressing Stop ends the line. This line is saved internally on the system and cannot be added to. Use the Left and Right directional arrow buttons to scroll and view data not currently displayed on the screen.

6.5 Flags

Flags are often inserted to mark noteworthy surface features, such as poles, sidewalks, changes in terrain etc. These markers may help you correlate subsurface targets with above ground features.

Pressing the **asterisk** button on the keypad will insert a flag at your current position, either during forward data acquisition or when backed-up. Flags are sequentially numbered (Figure 6-7).

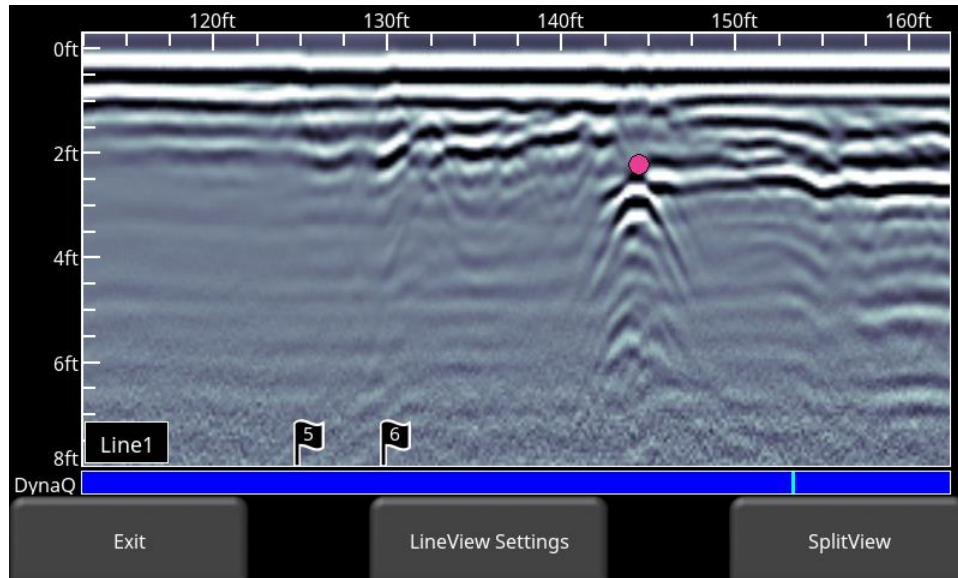

Figure 6-7: Inserting Flags

6.6 SplitView

When the external GPS is connected, the user is able to split the screen to show Line Scan data being acquired, as well as a real time MapView display. Press the **SplitView** button to see this view (Figure 6-8). The quality of the GPS signal received is always shown in the lower left of the LineView display; this is explained at the beginning of this chapter.

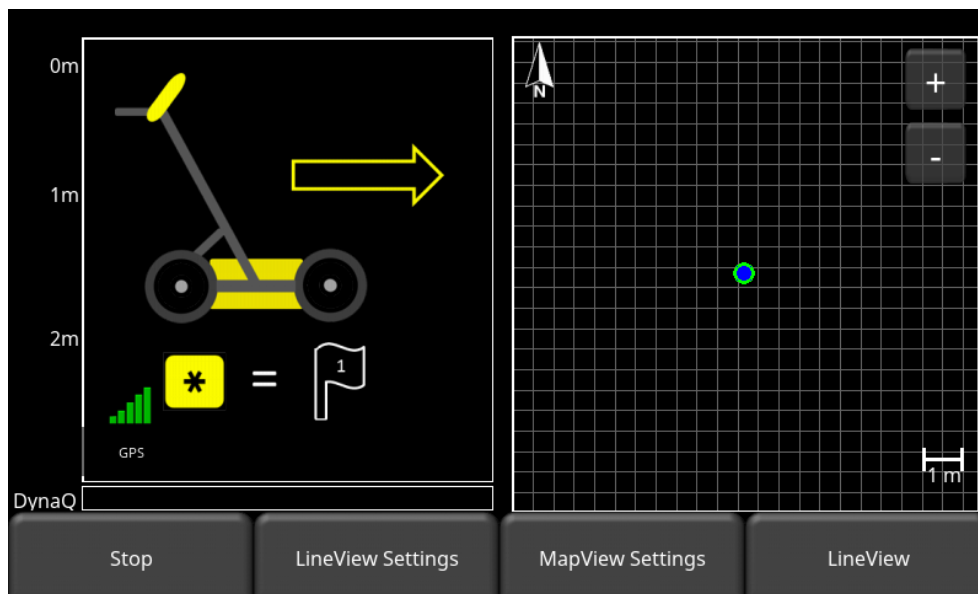

Figure 6-8: SplitView display, showing LineView on the left half and MapView on the right half

The current position of the system is shown as a blue dot with a green circle around it on the MapView display. As the system is moved and data is collected, your position is updated on the MapView side of the display. The path travelled is initially shown as an orange line. As more data is collected, part of the line will turn white, while a small section remains orange. This

orange section corresponds to the data shown on the left side. Pressing the left and right arrows on the 4-way directional keypad will display different sections of the data collected; this will also update which section you are viewing on the MapView display (Figure 6-9).

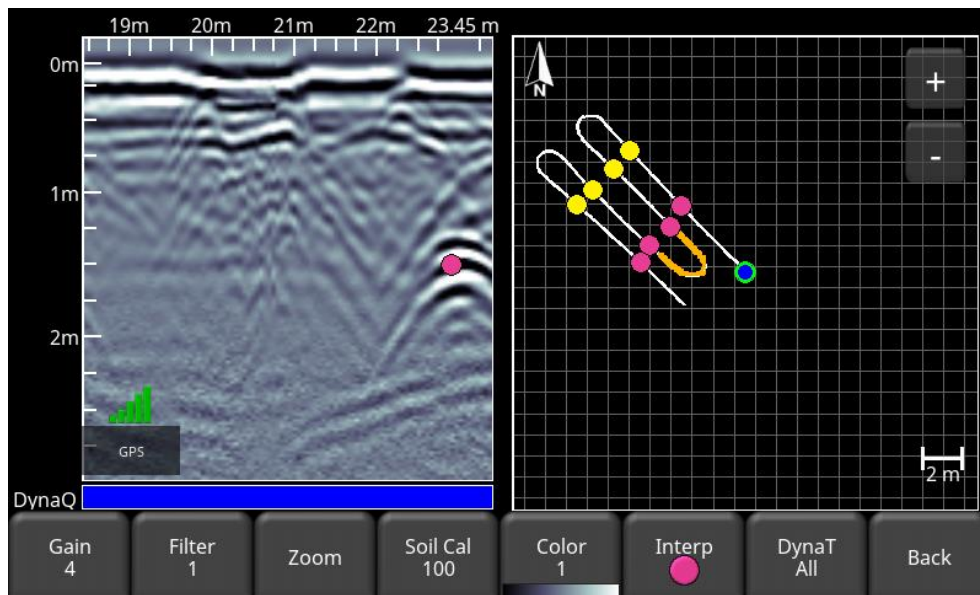

Figure 6-9: Collecting data in SplitView mode

In the LMX200, MapView will display all lines (collected with an external GPS) and grids (collected with internal or external GPS) on the system.

In the LMX200 Enhanced, MapView will display all lines (collected with an external GPS) and grids (collected with internal or external GPS) collected in a single project.

However, if lines/grids in a project (or any lines/grids in an LMX200) are collected far apart, MapView will only display them if they are collected within a 2.5km radius of the currently selected line. In this case, the data shown in the MapView display will follow the rules in the order below:

- Centre around the currently selected line or
- Centre around the highest line number collected with GPS or
- Centre around the highest grid number collected with GPS

If data exists outside the 2.5km radius, it will display the error message shown in Figure 6-10.

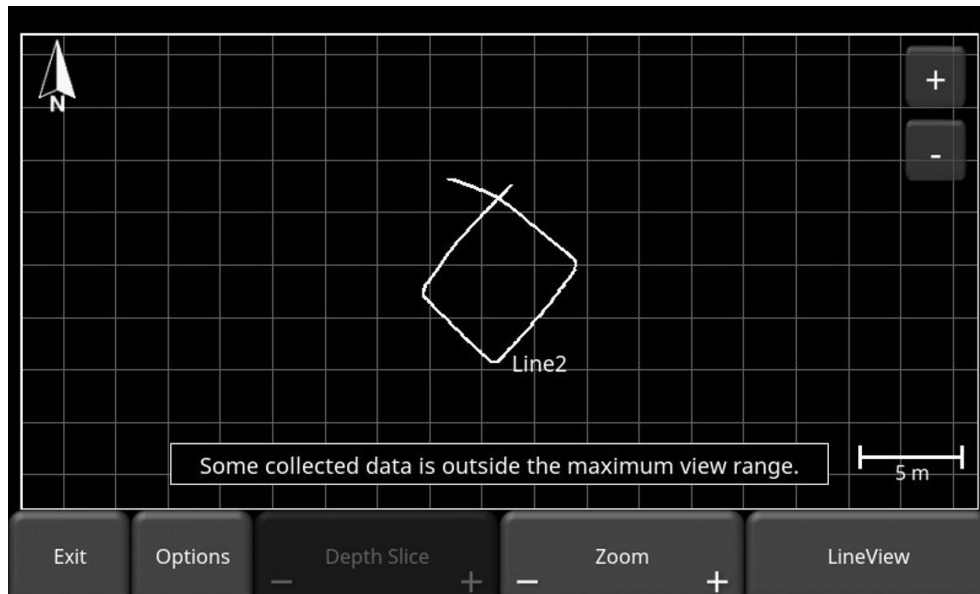

Figure 6-10: Warning message that some data is outside the MapView display range

Pressing the **LineView Settings** button will change the bottom menu options (Figure 6-9), while remaining in the SplitView display.

Pressing the **MapView Settings** button will display options for controlling the MapView display. This is explained in [Section 9](#).

If you are collecting data in real-time you can press the **LineView** button to return to full screen LineView. If you are reviewing previously collected data, you will see the **MapView** button instead. Pressing this will take you to a full screen MapView display, which is also explained in [Section 9](#).

6.7 View Settings

From the screen shown in Figure 6-7 or Figure 6-8, press the **LineView Settings** button to see options at the bottom of the screen (Figure 6-11). These options (described below) change the way the data is viewed on the screen. They do not alter the saved data in any way. These settings can be changed while you are still collecting data, after you have pressed **Stop**, or when viewing a previously saved line.

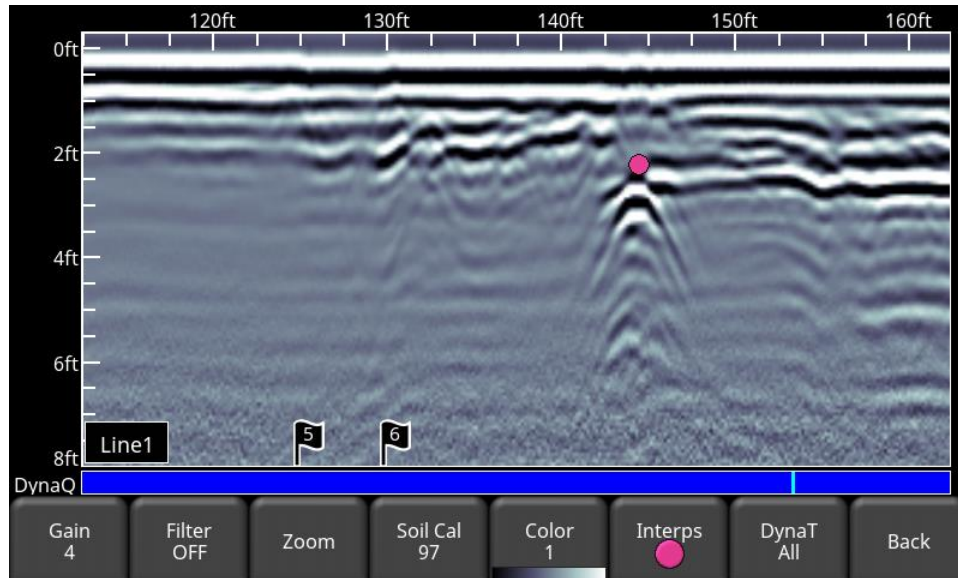

Figure 6-11: Menu at bottom of screen, after pressing View Settings

6.7.1 Zoom

This button controls the horizontal and vertical scaling of the displayed GPR data. Pressing the **Zoom** button changes the buttons on the bottom menu, which are explained below:

- **Depth** – Pressing **+** and **-** under the **Depth** button allows you to change the display depth of the data. This is commonly referred to as the depth window. The pre-set values range from 1m to 8m (3' to 25'), see Figure 6-12.

If the data was collected with a shallower depth, the depth setting can still be increased after the fact, when reviewing the data. In general, it's a good idea to set your displayed depth to 1.5 - 2 times the depth you expect the deepest target to be.

- **Position** – Pressing **+** and **-** under the **Position** button allows you to change the length of data displayed on a single screen. This is also known as horizontal scaling. The pre-set values range from 10m to 30m (25' to 100'), see Figure 6-13. One reason for setting this to 30m would be to fit more data on the screen and look for consistency among hyperbolas that were crossed.

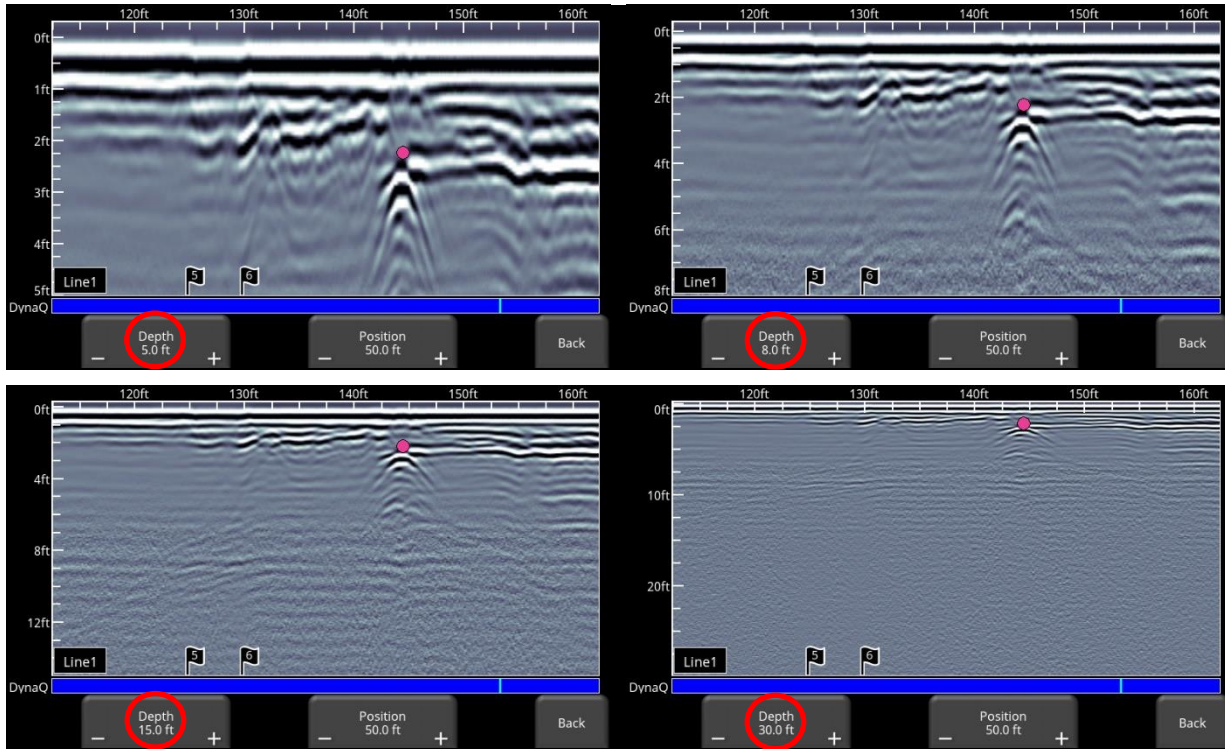

Figure 6-12: Varying displayed depth

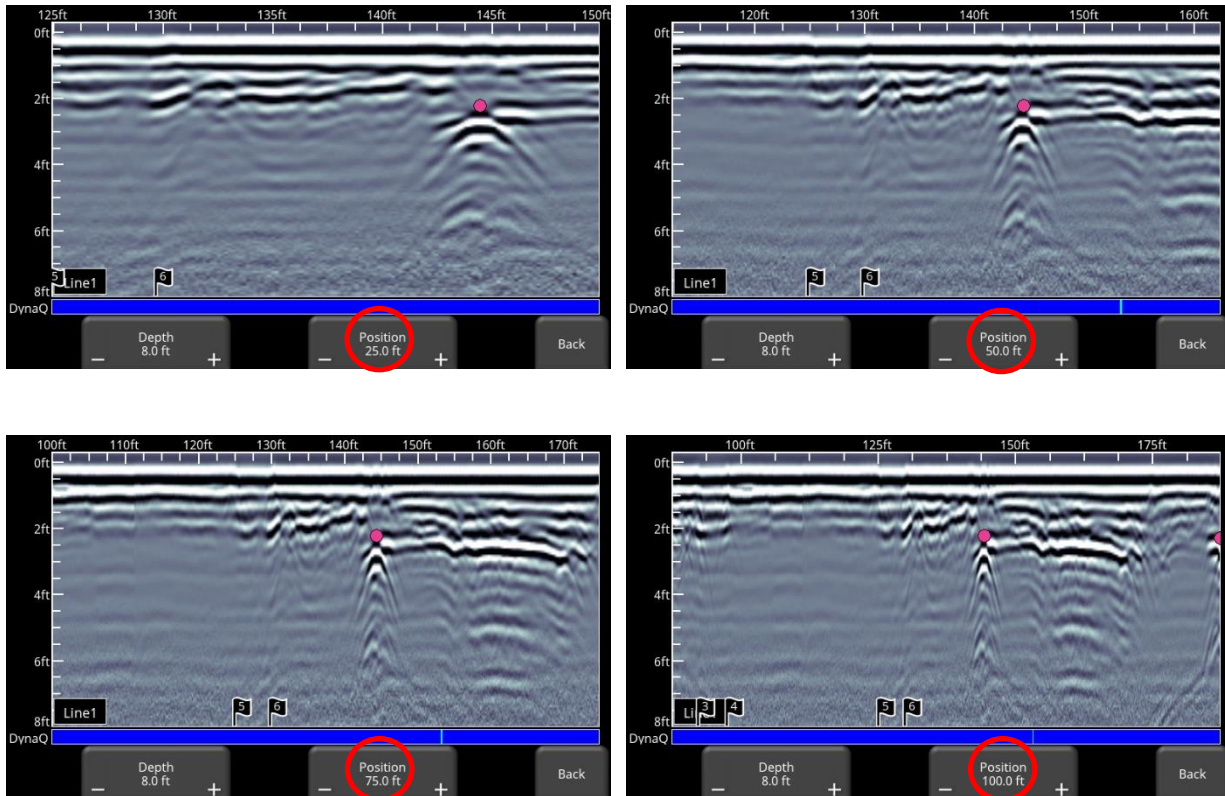

Figure 6-13: Varying position, or horizontal scaling

6.7.2 Color

Pressing this changes the color palette for the GPR Lines. There are 9 different color palette options. Pressing this button increments the color number and re-displays the image; once you reach 9 it cycles back to 1. A few sample color palettes are shown in Figure 6-14.

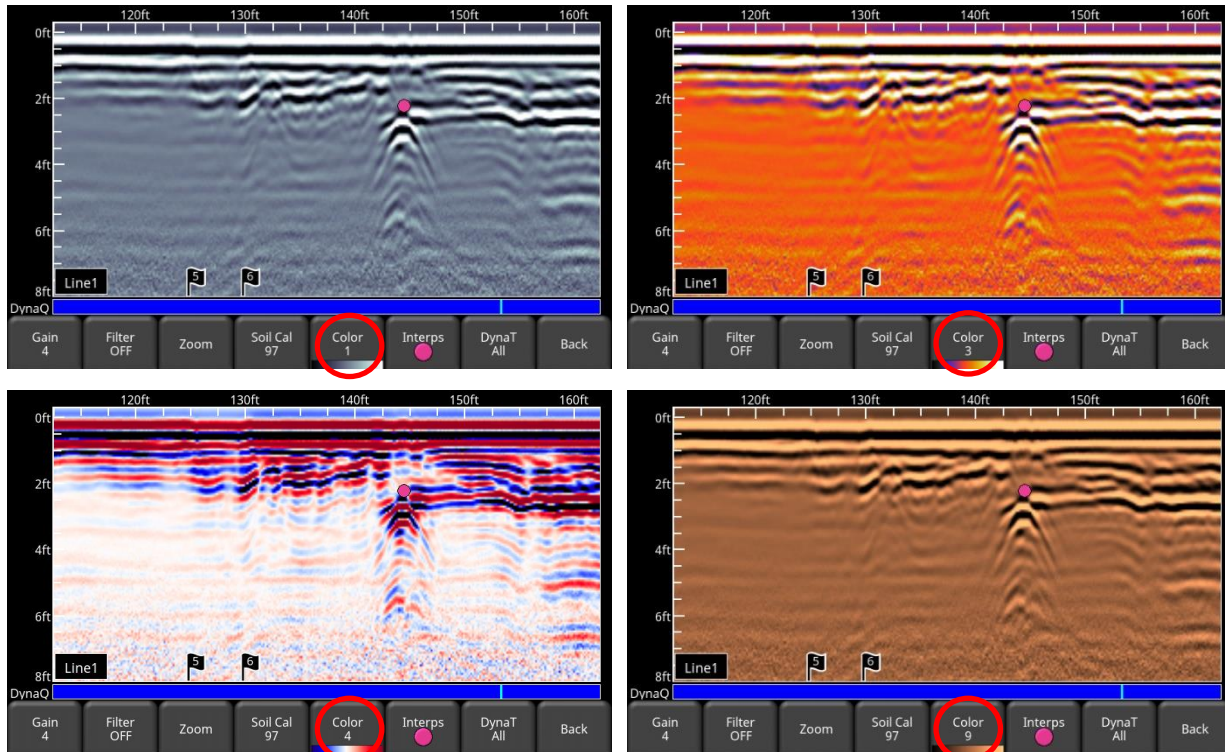

Figure 6-14: Changing Color palettes

6.7.3 Filter

The Filter is a background subtraction filter used for removing flat-lying responses in the data. Filtering helps identify shallow targets that might be masked by the strong signals at the top of the image, as well as possibly enhancing the visibility of hyperbolas further down in the data. However, it will also filter out other flat-lying responses, such as soil boundaries, so be careful when using this option if your target is flat.

It works by applying a running-average background subtraction to the data set, defined by the filter width or a window. This window “moves” across the data and the result is subtracted for every trace in the data set. The Filter is variable and pressing this button cycles between **OFF** and values **1** to **5**. Variable filter lengths are shown in Figure 6-15

The lower the number, the longer the filter width, and the more “relaxed” the filter. Only the longer flat-lying features get removed.

The higher the number, the shorter the filter width, and the more “aggressive” the filter. This results in the removal of long and short flat-lying features.

Pressing **OFF** turns the filter off completely.

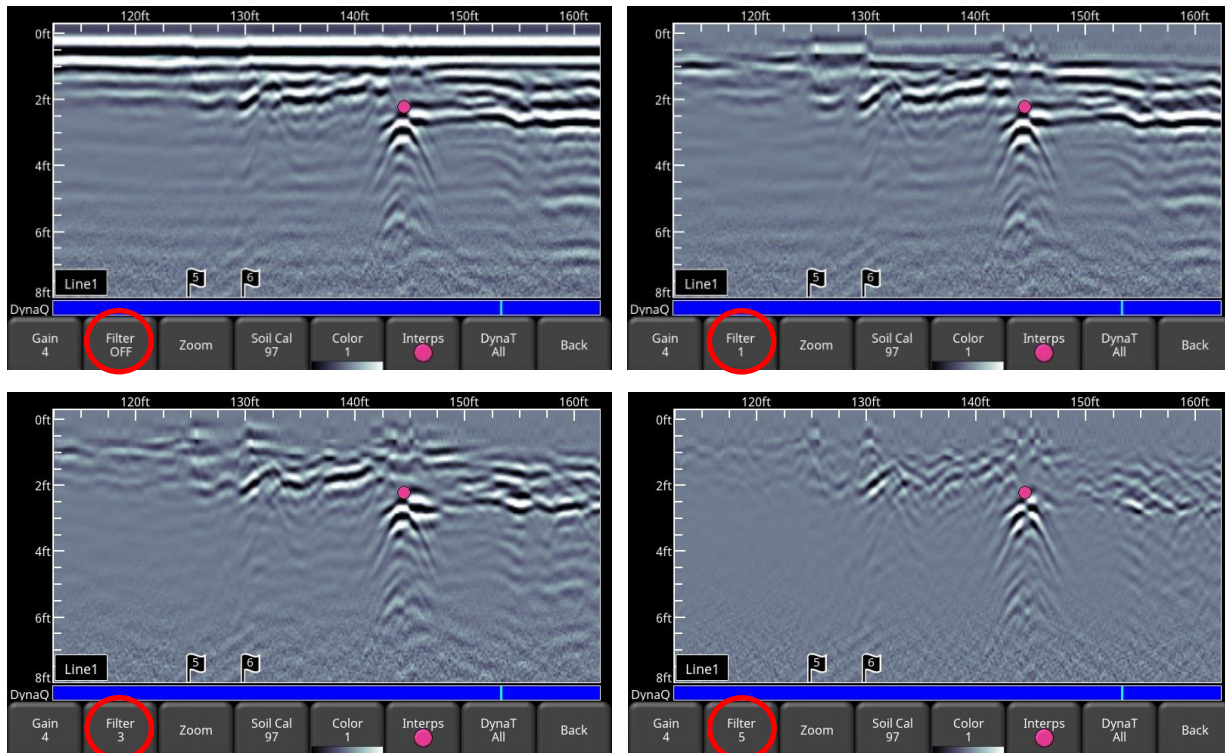
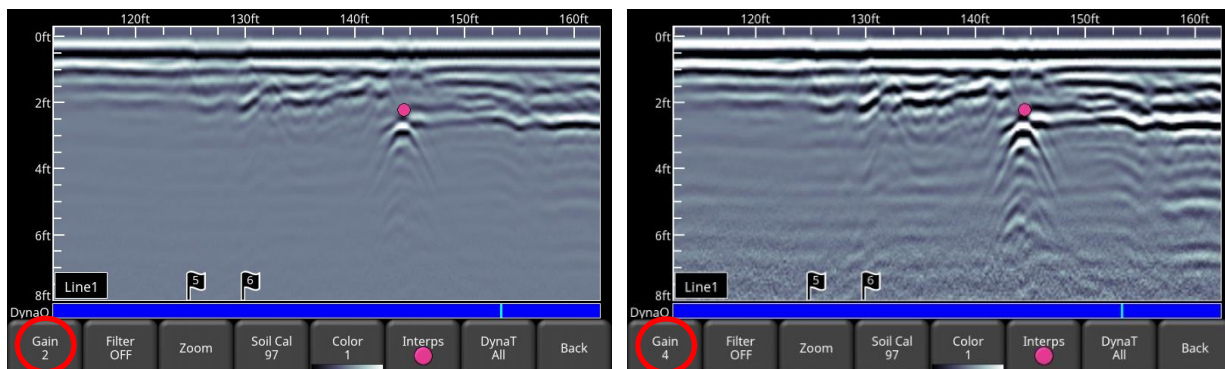

Figure 6-15: Showing variable filter lengths, and Filter Off

6.7.4 Gain

Since the material being scanned absorbs the GPR signal, deeper targets return weaker signals. Gain acts like an audio volume control, amplifying signals and making deeper targets appear stronger in the image. Gain values vary from 1 to 9 where 1 means a minimal amplification has been applied and 9 means that maximum amplification has been applied. Pressing this button increments the gain; once you reach 9 it cycles back to 1. Avoid over-gaining the data as it can make interpretation difficult (Figure 6-16). In general, soils that are more electrically conductive (e.g. clays) will require a higher gain compared to soils that are less electrically conductive (e.g. sand).



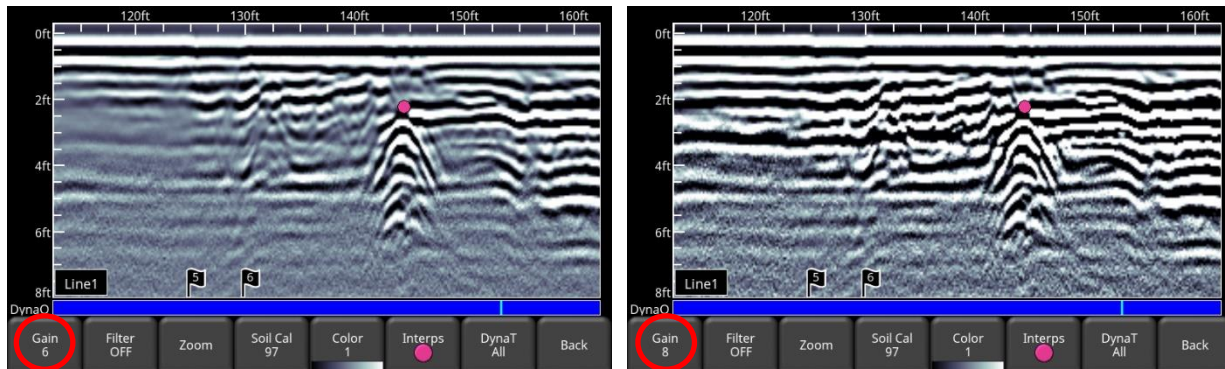

Figure 6-16: Varying the Gain

6.7.5 DynaT

DynaT is a feature that can selectively enhance small, medium or large size targets for easier viewing and detection (Figure 6-17). Pressing **DynaT** cycles between options: **All**, **Small**, **Medium** and **Large**. Each option allows the user to enhance part of the ultra-wide band (UWB) spectrum to focus on those desired features.

Selecting **Small** will show more of the smaller hyperbolas and more detail, whereas **Large** will focus more on the larger targets with better depth penetration. Selecting **All** will show a combination of small, medium and large targets.

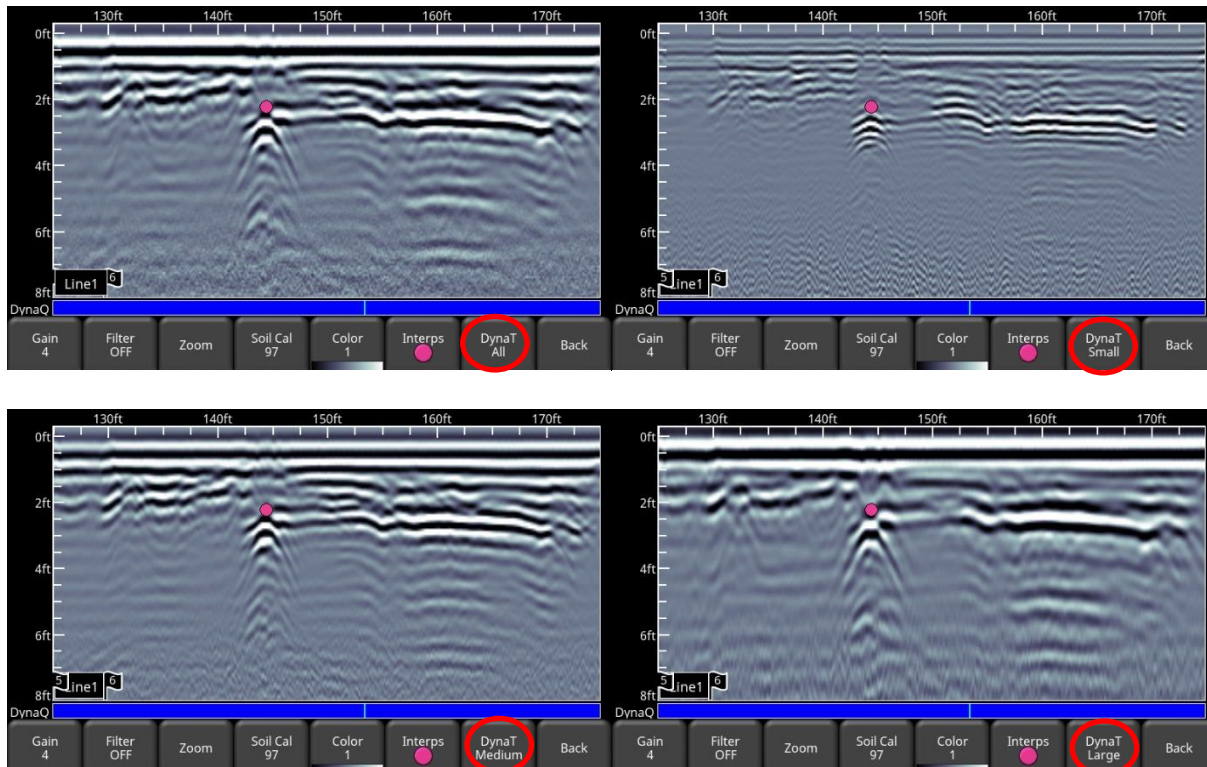

Figure 6-17: DynaT settings: a) Top left shows All b) Top right set to Small targets c) Bottom left set to Medium targets d) Bottom right set to Large targets

6.7.6 Soil Cal

The Soil Cal (also known as velocity) is a parameter used to ensure that measured depths are accurate. The best way to ensure this is by using the hyperbola-fitting method, since it is based on data collected in the area.

Crossing linear targets like pipes or cables at a 90 degree angle produces a hyperbola suitable for soil calibration. The Soil Cal value obtained will be used to compute a depth estimate of a target. These depths will be *incorrect* if the soil type is calibrated on a target hyperbola produced at an oblique angle, rather than 90 degrees.

Once you have a hyperbola on the screen from a subsurface target, press **Soil Cal**. The menu at the bottom of the screen will change, giving you the option of specifying a Soil Type or adjusting the Soil Cal using the hyperbola-fitting method (Figure 6-18). These options are explained below:

- **Soil Types** – If there are no targets to calibrate to, and you know the type of soil, press this button to vary between the following mediums, with the pre-set Soil Cal value shown in brackets:
 - very wet soil (60)
 - wet soil (80)
 - moist soil (100)
 - dry soil (120)
 - very dry soil (150)
 - air (300) – this value can be used to check for air waves, but it cannot be applied as a Soil Cal value
- **Soil Cal** – allows you to use hyperbola-fitting to determine a more accurate Soil Cal. The options are slightly different, depending whether or not you are in backup mode.

If the back-up indicator is on screen, it is presumed you have backed up the LMX100 and you're right over the hyperbola. Move the horizontal line to align with the top of the hyperbola by touching and dragging it. Pressing Soil Cal will display a hyperbola that is locked to the position where the back-up indicator meets the horizontal line (Figure 6-18).

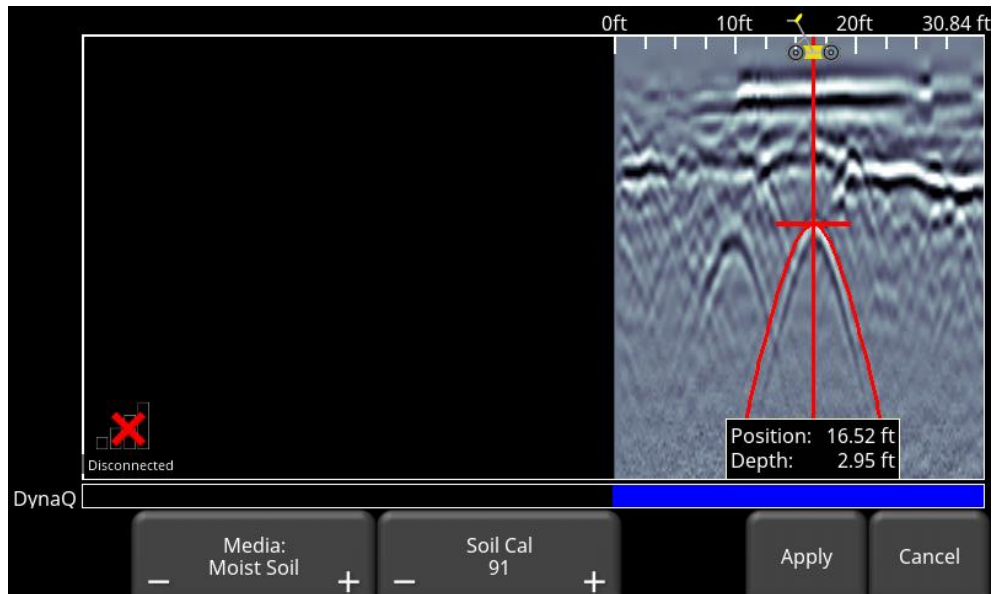
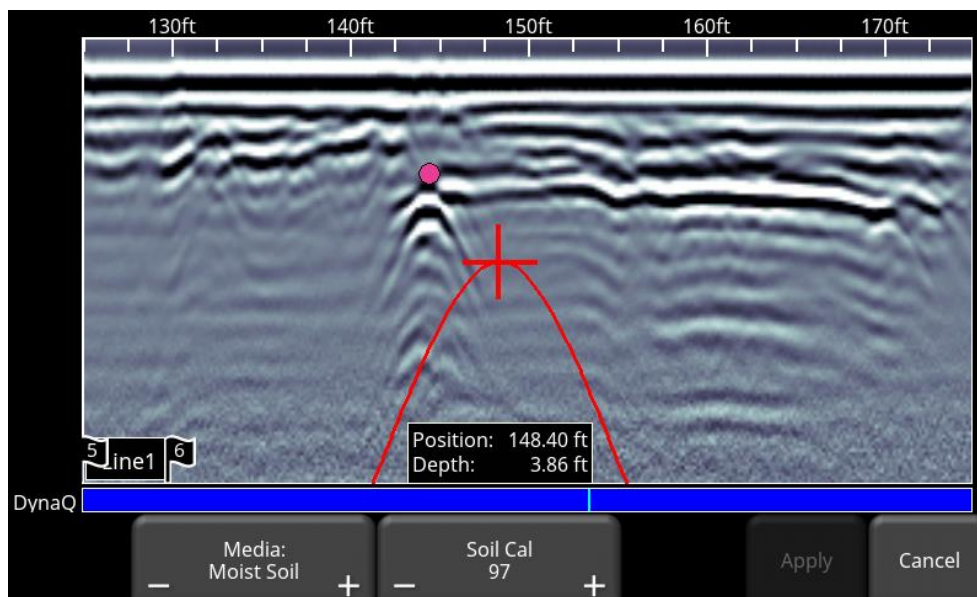

Figure 6-18: Adjusting Soil Cal while in backup mode

On the other hand, if you press **Soil Cal** while you are collecting data or have pressed **Stop**, you will see a red hyperbola in the middle of the screen. Drag the hyperbola such that it lies over a real hyperbola from the ground (Figure 6-19). You can use the 4-way keypad arrows to fine tune the movements.



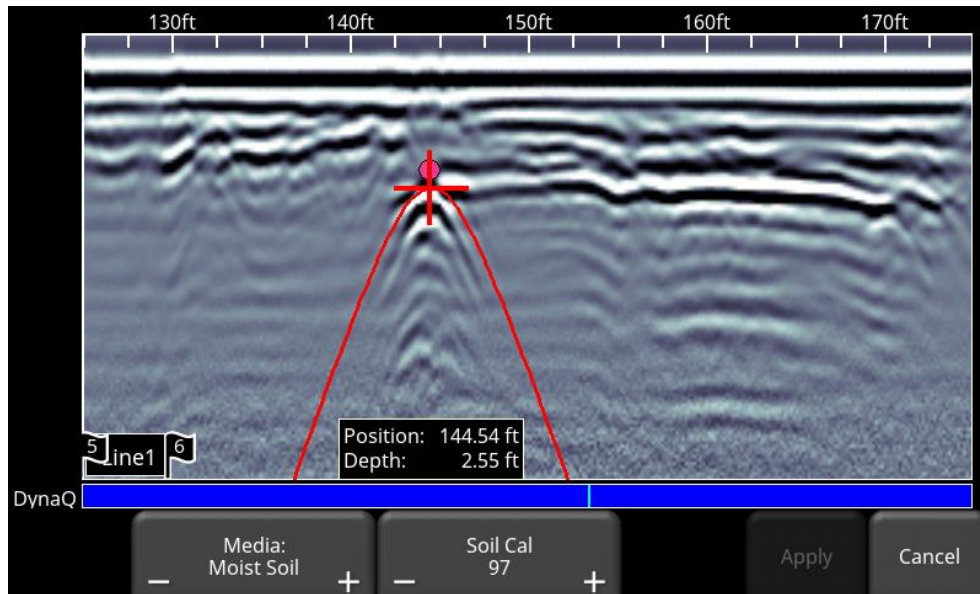

Figure 6-19: Adjusting Soil Cal, without backing up

For either scenario above, once the red hyperbola is properly positioned, you can now use the **+** and **-** buttons on the **Soil Cal** button to widen or tighten the shape. Once the shape is matched (Figure 6-18 and bottom image of Figure 6-19), you now have the correct Soil Cal and the measured depths will be most accurate. Press **Apply** to use this value.

If you get a Soil Cal near 300, this could be an Air Wave ([Section 5.5](#)), and you should calibrate to a different hyperbolic response.

6.7.7 Interp

Short for field interpretation, Interps are used to mark subsurface features. Seven colours are available, which allow you to designate different types of subsurface objects.

Either during collection, back-up or review, you can simply touch anywhere on the screen to add an Interpretation. This appears as a dot of whatever colour is selected. To change the color, press the **Interp** button to see a selection of colours and to select a new one (Figure 6-20).

To remove an Interp, ensure the same color is currently active and simply touch the Interp to delete it.

These field interpretations get exported with the data as a .CSV file, which show the positional information of all interps. They can be used to check if a feature is linear (in MapView or in Google Earth™), but only if the more accurate external GPS is used.

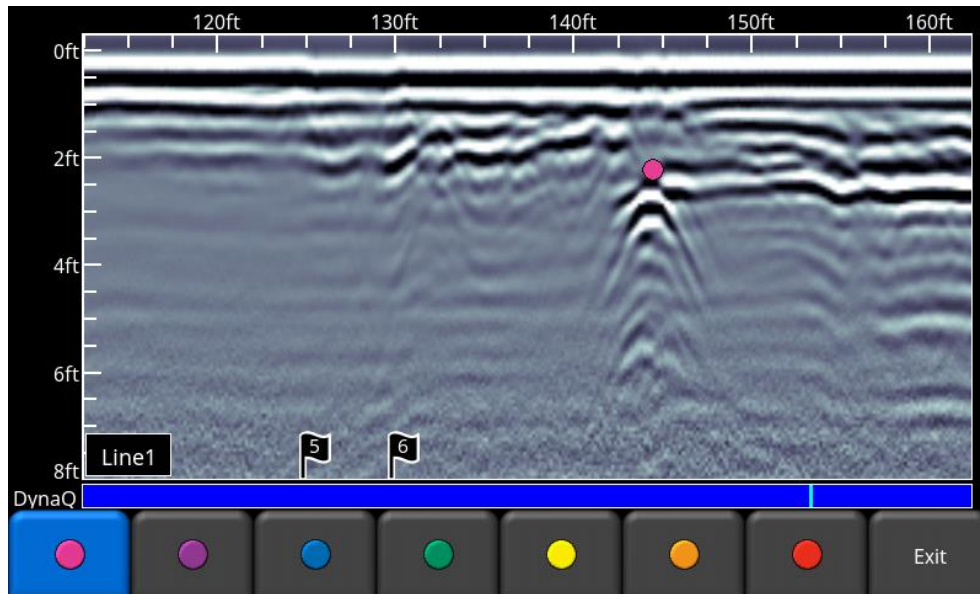

Figure 6-20: Available colors for Interps

6.7.8 Pause button (only available in No Save Mode)

The Pause button allows you to temporarily stop data collection and resume again, without clearing the data from the screen. This might be useful if you want to collect a series of parallel lines over a target and show all the passes on the screen for comparison.

Once you collect some data, press **Pause**. You can now move the LMX200 without data scrolling on the screen. When you are ready to resume collecting data, press Start. You will see a thick, red vertical line, corresponding to when you hit the Pause button and then restarted (Figure 6-21).

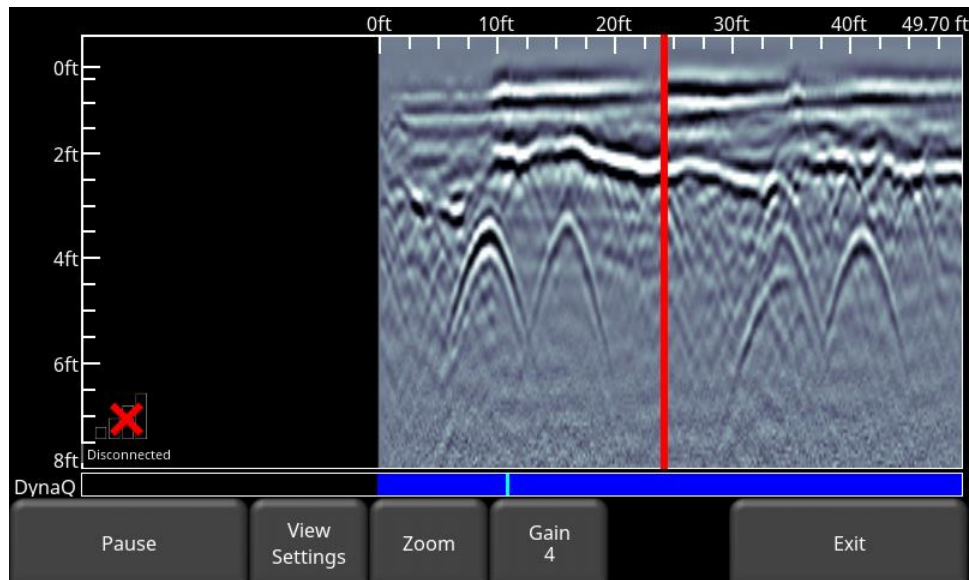

Figure 6-21: Pressing Pause and resuming data collection.

6.7.9 Drawing arrows (only available in No Save Mode)

There is no option for Interps in this mode, as the data is not being saved. However, you do have the ability to draw arrows on the screen (Figure 6-22).

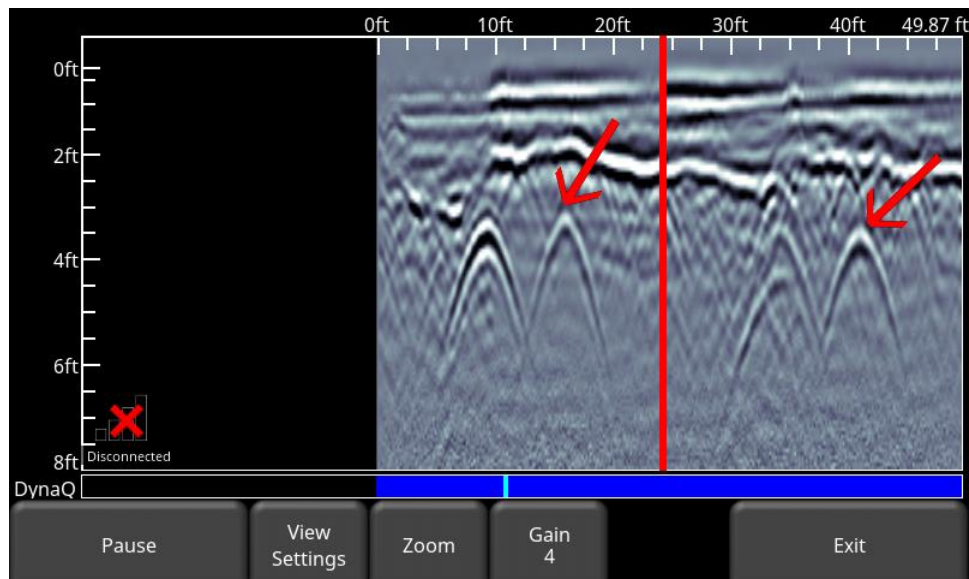

Figure 6-22: Drawing arrows on the screen to highlight targets and features

Touch the screen where you want the head of the arrow to appear, and then swipe away in the direction of the shaft. In the example in Figure 6-18, the user touched near the hyperbola, then swept their finger towards the top left to create the arrow. Just like Interps, any number of arrows can be drawn on this screen. Touch any arrow to remove it.

Remember that pressing the Camera button will take a screenshot and save it in the currently selected project.

7 Grid Scan

Grid scans are conducted to generate depth slices over a given area. This is useful for locating all known and unknown objects, as well as their orientation, in a graphical manner that is easy to interpret.

From the main menu (either in Figure 3-2 or Figure 3-3), press the **Grid Scan** button to enter the Grid setup menu.

7.1 Grid Parameters

The screen in Figure 7-1 will allow you to set parameters for the grid, before data acquisition begins.

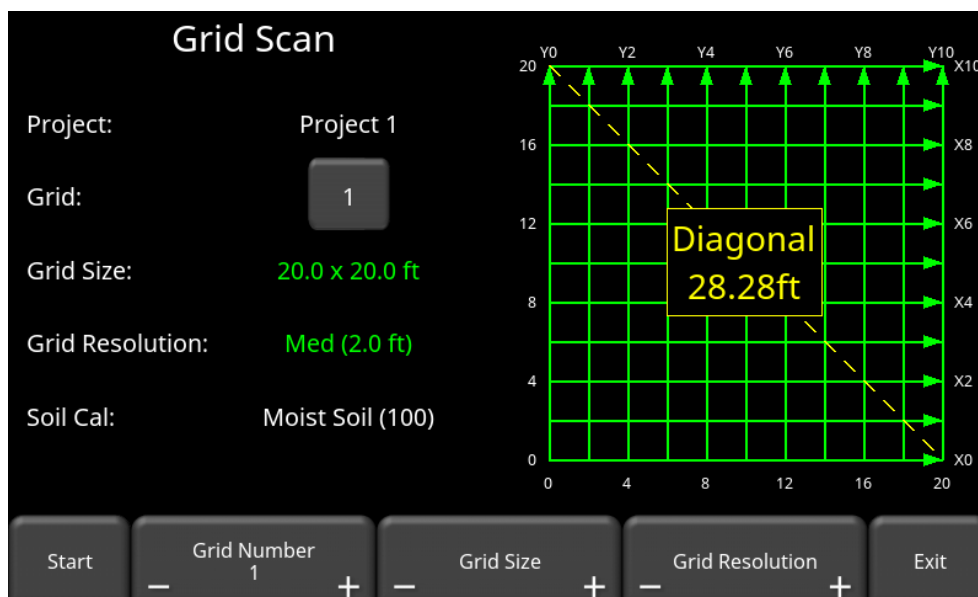

Figure 7-1: Grid Scan setup, from the Enhanced system. On the standard LMX200, it will be the same, except there will not be a project number

7.1.1 Grid Number

To select a grid size, press the **+** and **-** buttons under **Grid Number** at the bottom of the screen. Alternatively, pressing the grid number button itself will show the screen in Figure 7-2. From here, you can go directly to any grid. Grids that contain no data will have the text shown in green.

If a grid already contains some data, it will be shown in red and you will not be able to change the size or resolution. You will just have the option to select:

- **SliceView** – view the depth slices
- **Delete Grid** – delete all the data in this grid

You can press Start to enter a previously collected grid, either to view data or recollect a line.

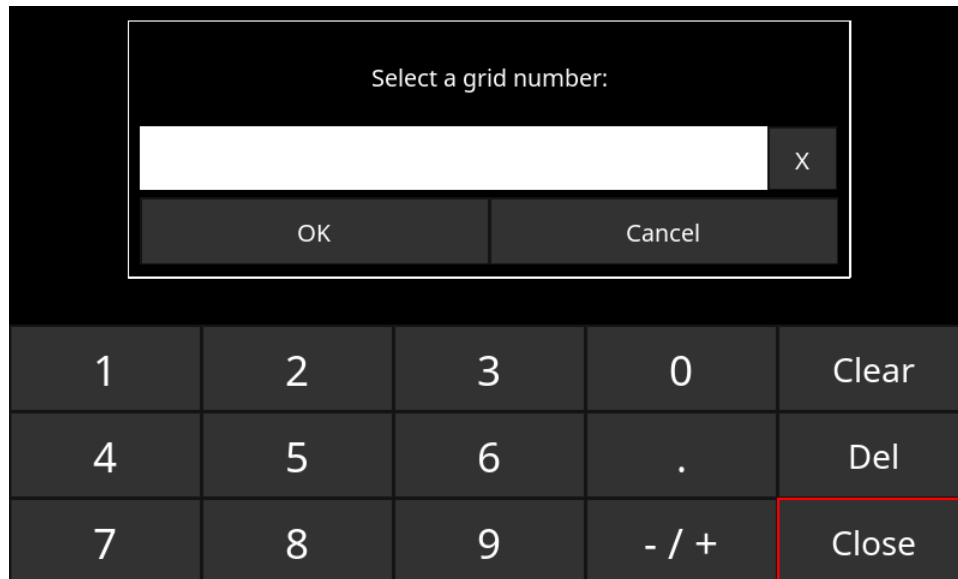

Figure 7-2: When the button showing the grid number is pressed, this screen allows the user to directly input the grid they wish to go to

7.1.2 Grid Size

Press the + and - buttons under **Grid Size** at the bottom of the screen to change the dimensions of the grid. Alternatively, you can press the + and - buttons on the screen beside **Grid Size** on the upper part of the screen.

In metric units, the available grid sizes are 5m x 5m, 10m x 10m and 15m x 15m.

In US standard units, the available grid sizes are 10ft x 10ft, 20ft x 20ft and 50ft x 50ft

7.1.3 Grid Resolution

Grid resolution determines the spacing between grid lines. This can be varied by pressing the + and - buttons under **Grid Resolution** at the bottom of the screen. Alternatively, you can press the + and - buttons on the screen beside **Grid Resolution** on the upper part of the screen.

Available options are 0.25m, 0.5m and 1.0m in metric units and 1, 2 & 5 feet in US standard units. The best images will result when the smallest resolution value is used.

Calculating Resolution

The size of target will determine line spacing. The system must pass over a target to detect it; line spacing needs to be on the order of the size of the target or smaller when practical. This can be adjusted to a larger spacing for larger targets or targets that are linear. As well, these rules may have to be bent for practical purposes such as survey production rates. Tighter line spacing takes longer to collect and may not be economically possible in all circumstances.

Note that the system will not allow you to select a 10'x10' grid with a low resolution of 5', as this resulting image will be very poor due to inadequate data collected.

7.1.4 Starting data collection

Press **Start** when all the parameters are setup and data collection is ready to begin.

7.2 Laying out the grid

Positional accuracy of each line is vital to locating targets of interest once data has been processed. Follow the steps below to layout the grid.

Step 1 – Define the axis- Lines parallel to the Y-Axis are called Y-Lines. Similarly, lines parallel to the X-axis are called X-Lines (Figure 7-3). Pick the origin of the grid such that it is the furthest corner away from any obstacles. This way, all the lines start properly, but they can be ended early if there is an obstruction.

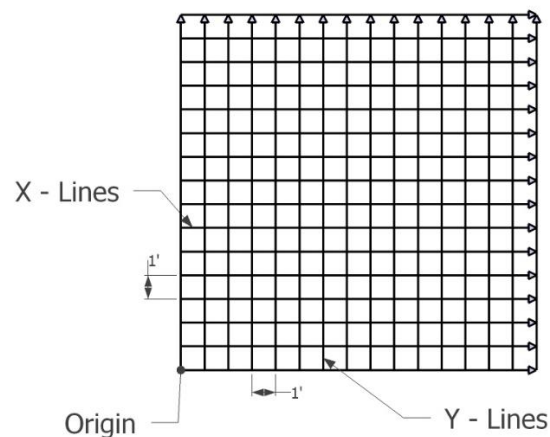

Figure 7-3: X-Lines and Y-Lines relative to the Origin.

Step 2 – Layout the Grid – for maximum accuracy, it's very important to establish a right-angle triangle (Figure 7-4). The easiest way is to use a single tape measure and refer to the diagram below. Start at the origin, walk out the desired distance for X-axis (A) and mark that point. Then then turn 90 degrees and walk out the desired distance for the Y-axis (B) and mark that point. Determine the hypotenuse side (C) from the screen (Figure 7-4), then close in the triangle (C - hypotenuse side) back to the origin, making sure you meet the origin at the distance for C. If not, move that last point in tandem with the origin, such that both sides of the tape measure are taut.

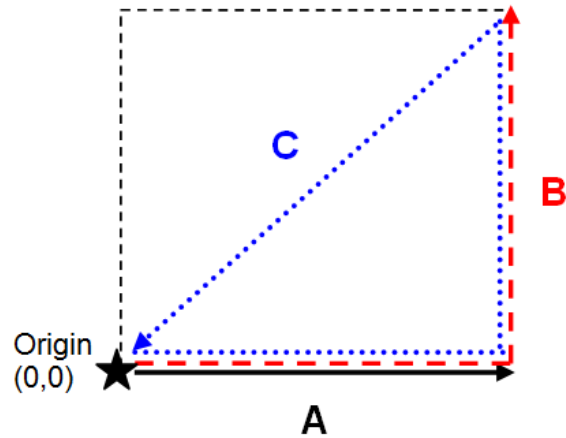

Figure 7-4: Forming a right-angle triangle

Step 3 – Mark the Line Start Positions – with the tape measure still on the ground, mark the line start positions based on the line spacings (Figure 7-5). Usually flags or paint work for grass, and chalk or paint on concrete. It is also recommended to paint a distance measurement every so often, in case you forget which line you're on.

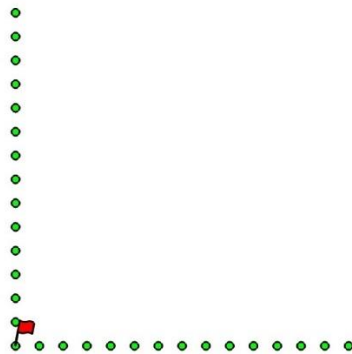

Figure 7-5: Marking the line spacing and starting positions for every line

Step 4 – Mark the End Positions – if you are doing a forward only grid, it is recommended to mark the end positions (Figure 7-6). You will need to aim for something to make sure your line is straight.

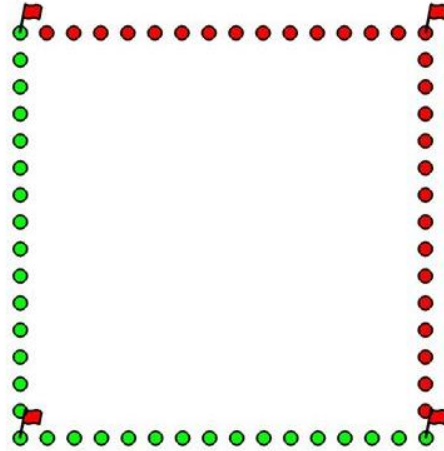

Figure 7-6: Marking ending positions

For linear targets such as pipes and utilities, the best GPR responses occur when the GPR survey line crosses the target at right angles. Keep this in mind when laying out the grid and the orientation. Sometimes, laying out a grid with straight lines and corners at 90 degree angles can be difficult.

An example grid layout is shown in Figure 7-7.



Figure 7-7: Example of a grid survey. The red lines are superimposed just to illustrate the concept.

7.3 Data Collection

7.3.1 Physical Data collection

It is critical that the starting position is consistent on every line. Line up the middle of the unit with the starting line, and then push the system straight towards the end of the line. It is helpful to have a marker at the end so you have something to aim for.

7.3.2 Data collection on the Display Unit

The data collection screen is shown in Figure 7-8. The right half of the screen is a graphic representation of the grid, illustrating the size of the grid and the lines that need to be collected. The left half of the screen will display the last grid line collected.

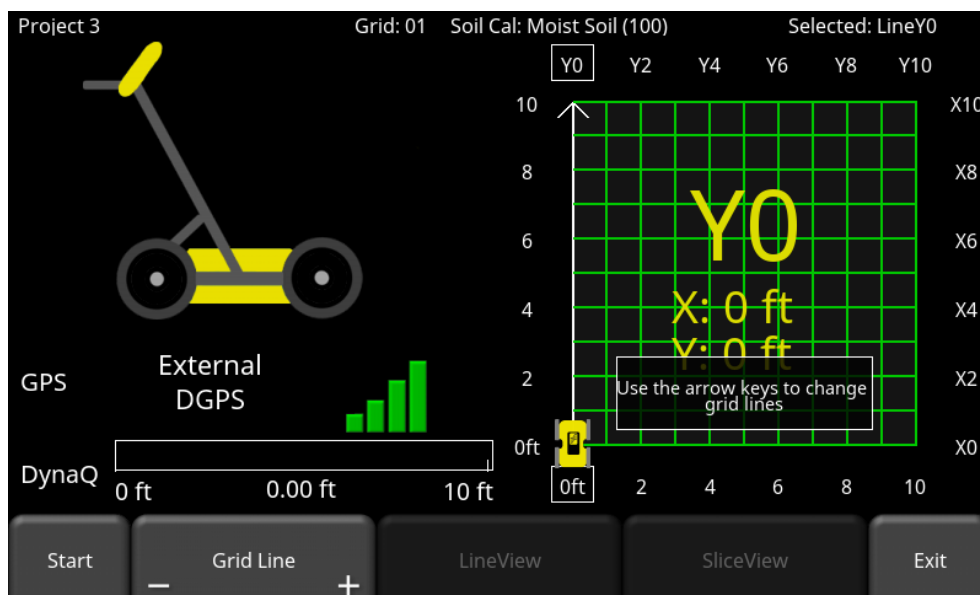

Figure 7-8: Grid collection screen prior to any data collection

Press **Start** when you are positioned at the start of the line. Push the system in a straight line towards the end of the line. The system knows the length of each line, and will automatically stop acquisition once that distance has been covered. If the data acquisition ends prior to reaching the end of the line, or continues noticeably past it, you likely need to do an Odometer Calibration ([Section 4.2.6](#)).

Once data is collected, the Grid Line will turn red and the system will beep twice. The current line will now advance to the next one and is shown in white. The remaining lines to be collected are shown in green (Figure 7-9).

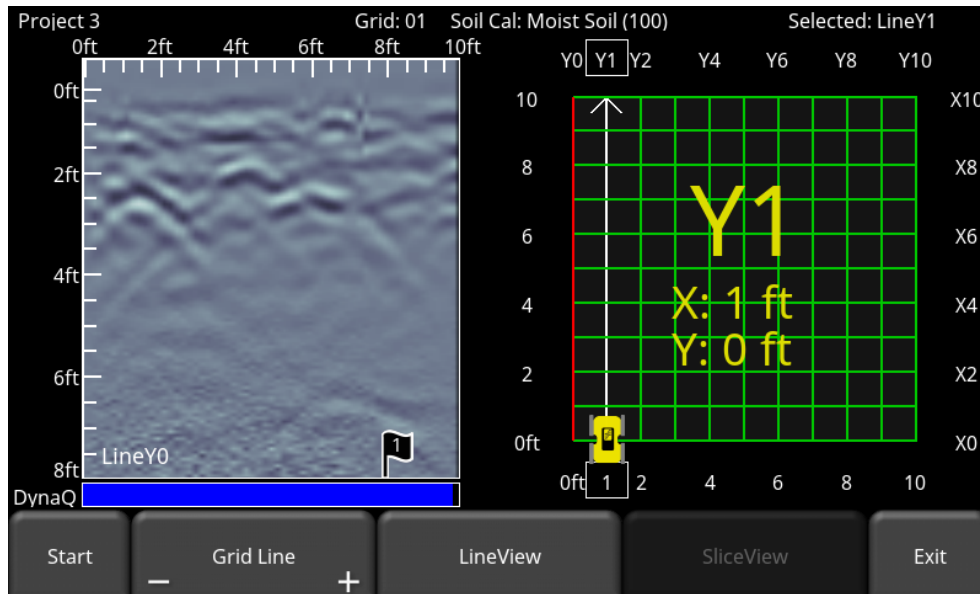

Figure 7-9: Display after the first grid line is collected

Move back to the start of the next line and repeat the process. Once all the lines are done in one direction, it will automatically prompt you to collect lines in the other direction.

Not all lines have to be collected. If your area of interest is only 4m x 4m, set the Grid Size to 5m x 5m, but just don't collect the outer lines.

7.3.3 Obstacles in your path

If there is an obstruction preventing you from finishing the line (such as a tree or rock), do not try to steer the system around the obstruction, as this will throw off the positioning of the data. When you approach the obstruction, end the line by pressing **End Line**. The software will move you to the start of next line.

You now have the option to collect a “reverse” line from the other direction. Press the Grid Line **minus** button to move to the previous line, but in the reverse direction. Alternatively, you can also press the left or down arrow (depending which axis you're on) on the 4-way directional keypad to move to the previous line in the reverse direction. The name of the line will now contain an R at the end. Press **Start** to collect this line and then **End Line** to end the line when you hit the obstruction.

The example in Figure 7-10 shows that line Y3 was not complete, so a reverse line was added to it.

You can also choose not to collect a reverse line right away. Once you are done all the lines in that direction (e.g. Y lines), the software will automatically return to any incomplete lines in that direction and give you the opportunity to collect a reverse line.

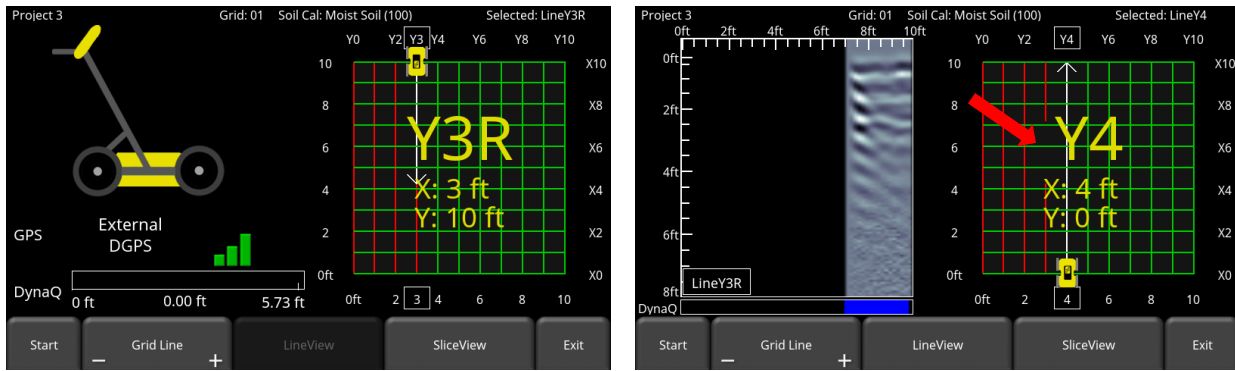

Figure 7-10: Collecting a reverse line around an obstacle

A completed grid with an obstacle in the middle, might look like the image in Figure 7-11.

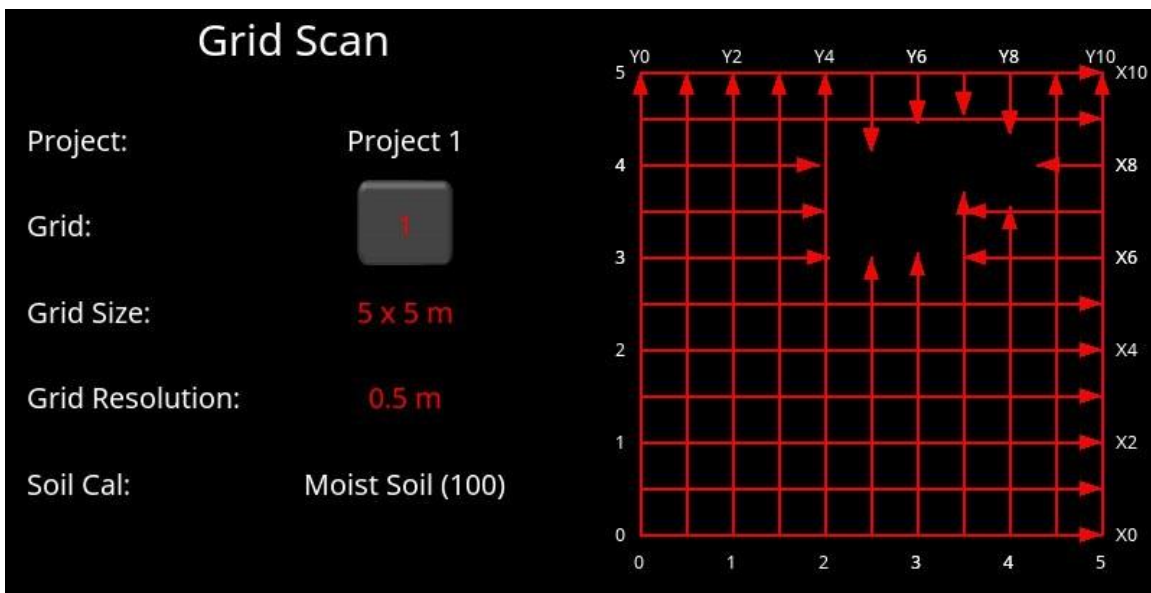

Figure 7-11: Completed grid with obstacle

7.3.4 Flags

Flags are often inserted to mark noteworthy surface features, such as poles, sidewalks, changes in terrain etc. These markers may help you correlate subsurface targets with above ground features.

Pressing the **asterisk** button on the keypad will insert a flag at your current position. The flag is displayed on the line scan image (Figure 7-9), and will also show up on the depth slices in SliceView ([Section 8](#)). Flags are sequentially numbered.

7.3.5 LineView

To display the currently selected grid line on the full screen, press the **LineView** button (Figure 7-12). In this view, you have the option of modifying the image by changing the Zoom, Color,

Filter, Gain and Soil Cal values. It is also possible to display other collected grid lines using the keypad arrow buttons.

To exit from the LineView screen and return to Grid View, press the **Back** button. The Grid View screen respects any display settings changed while in LineView. If the Soil Cal is changed, the depth slices will be reprocessed.

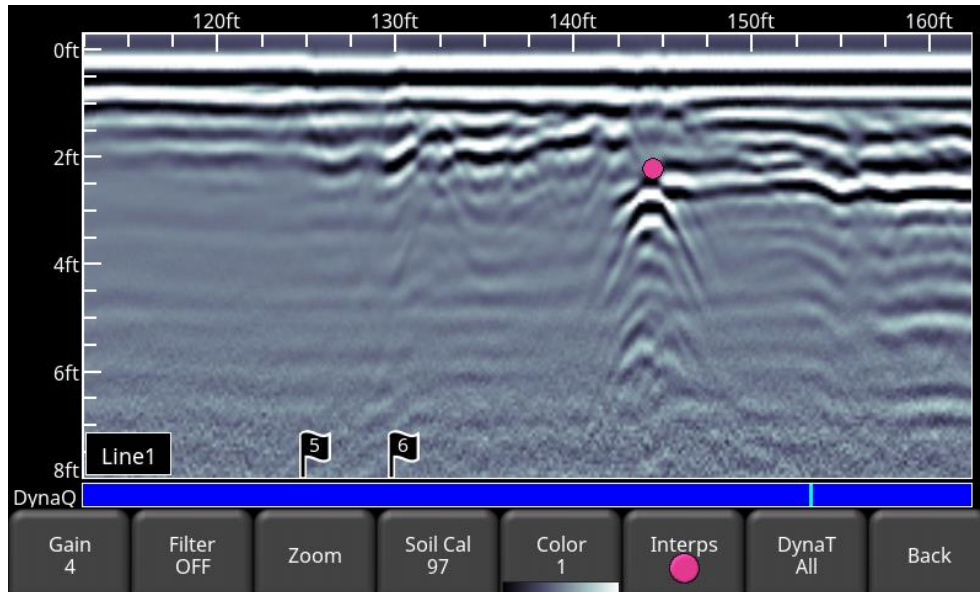

Figure 7-12: LineView screen

7.3.6 Recollecting & skipping lines

You may want to recollect a line if you make a mistake. To move to a different line:

- Press the **+** and **-** buttons under **Grid Line** OR
- Touch any **line** on the grid image on the right OR
- Use the **4-way directional keypad**

Then simply hit **Start**. You will be prompted with a message asking if you want to overwrite that line (Figure 7-13). Press **Yes** to proceed.

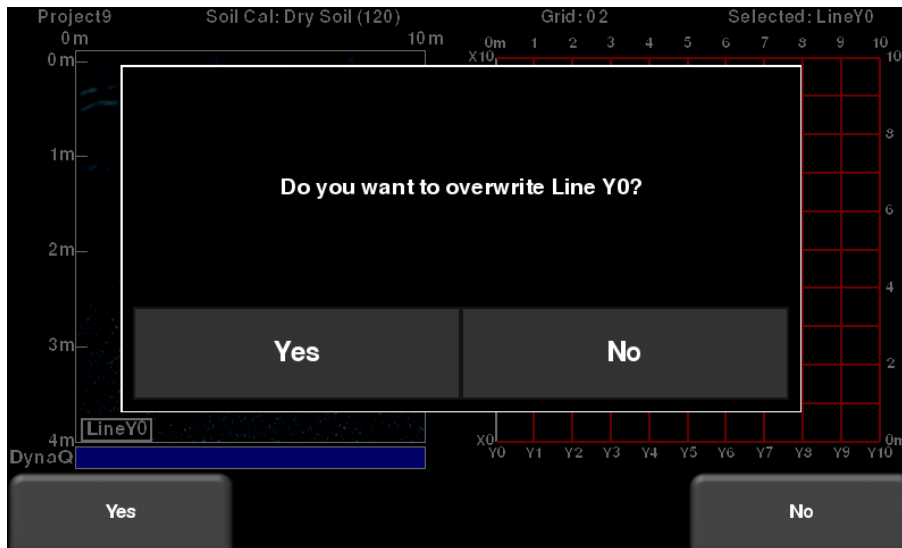

Figure 7-13: Overwriting a line

7.3.7 Processing data

Once you have finished collecting all the data, press **SliceView** at the bottom of the screen. Before the data is processed and depth slices created, you must ensure the Soil Cal is accurate; this will result in the most accurate and sharpest images.

A message will display advising the Soil Cal that will be used (Figure 7-14). If you have adjusted this already for the ground you are on, you can press **OK** to proceed and create the depth slices. If not, then it is recommended to press **Cancel** and adjust the Soil Cal by using a good hyperbola on one of the collected lines. Then return and press **SliceView** and press **OK** to proceed and create the depth slices.

See the next section on using **SliceView**.

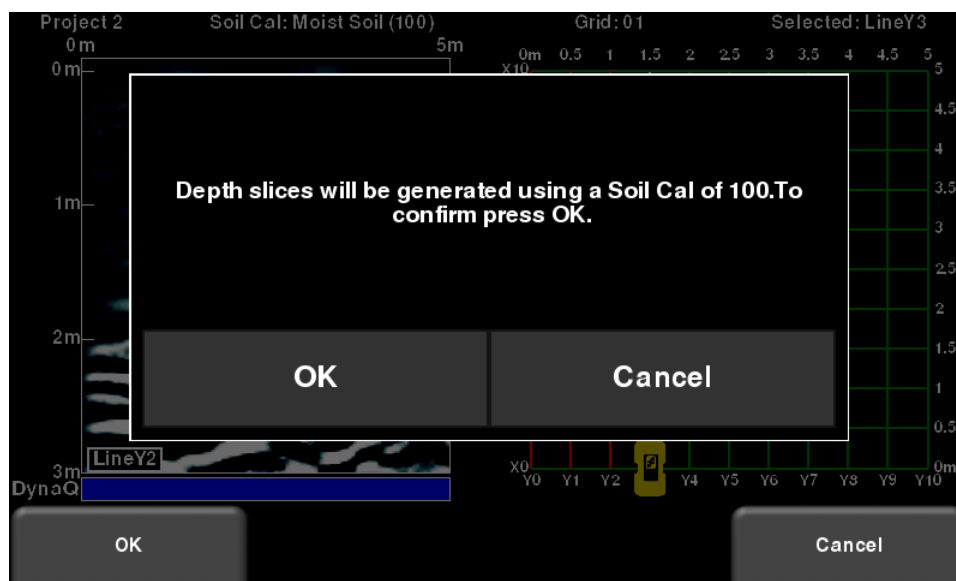

Figure 7-14: Processing with Soil Cal value

8 SliceView

SliceView displays data collected in a grid as a series of depth slices moving deeper into the subsurface. Objects and features appear in plan view, which can be an easier way of visualizing the data.

Upon entering SliceView, the screen will be displayed as shown in Figure 8-1.

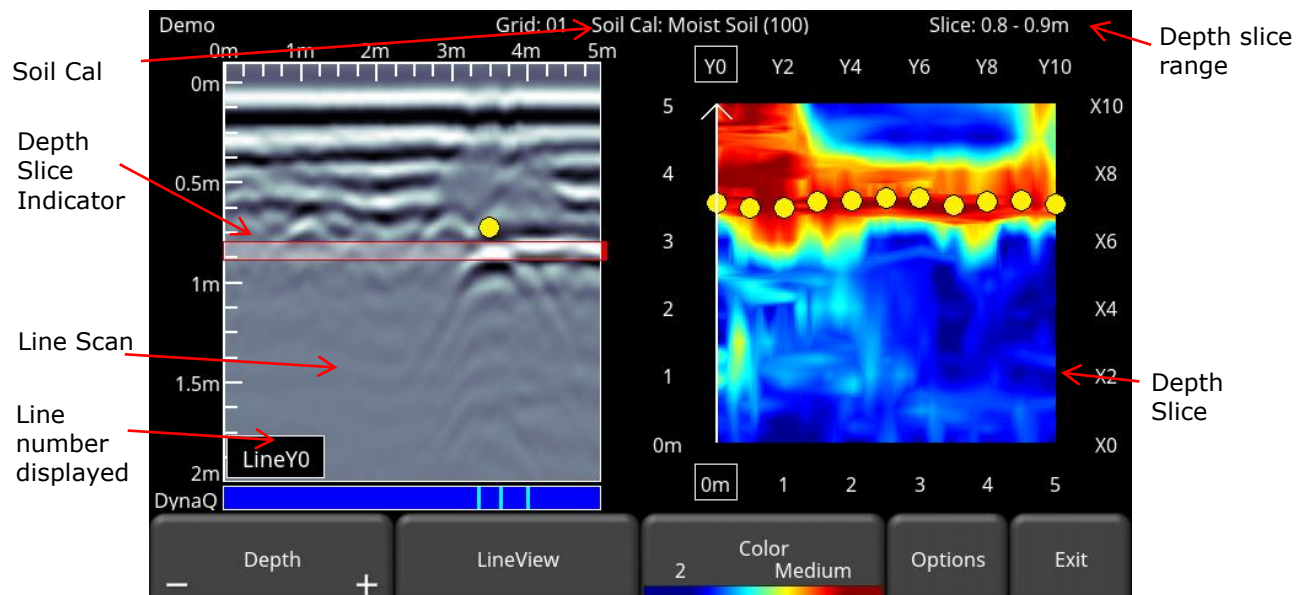

Figure 8-1: SliceView screen

The right half of the screen shows one of the depth slices. These slices are 10cm or 4" thick. The top and right sides of this image show the dimensions of the grid while the left and bottom sides show the line numbers.

The left half of the screen displays one of the grid lines, and any flags or interpretations that were made. The shaded area in between the horizontal red lines corresponds to the depth slice shown on the right. To move to another grid line, use the 4-way directional keypad on the Display Unit.

At the top of the screen, the grid number is listed, along with the Soil Cal value and slice thickness range.

The button functionality is explained below:

8.1 Depth

Pressing the + and - buttons on the **Depth** button will increase or decrease the depth of the depth slice currently displayed. You can also drag the depth slice indicator on the line scan image. This allows the user to "slice through" the ground, and locate features that appear at different depths.

8.2 LineView

Pressing this button displays the currently selected GPR line as a full screen image. All the functionality of Line Scan (such as Depth, Color, Filter, Gain, DynaT, Soil Cal, Interps) are available here (Figure 8-2). Use the **4-way directional keypad** to change to a different line.

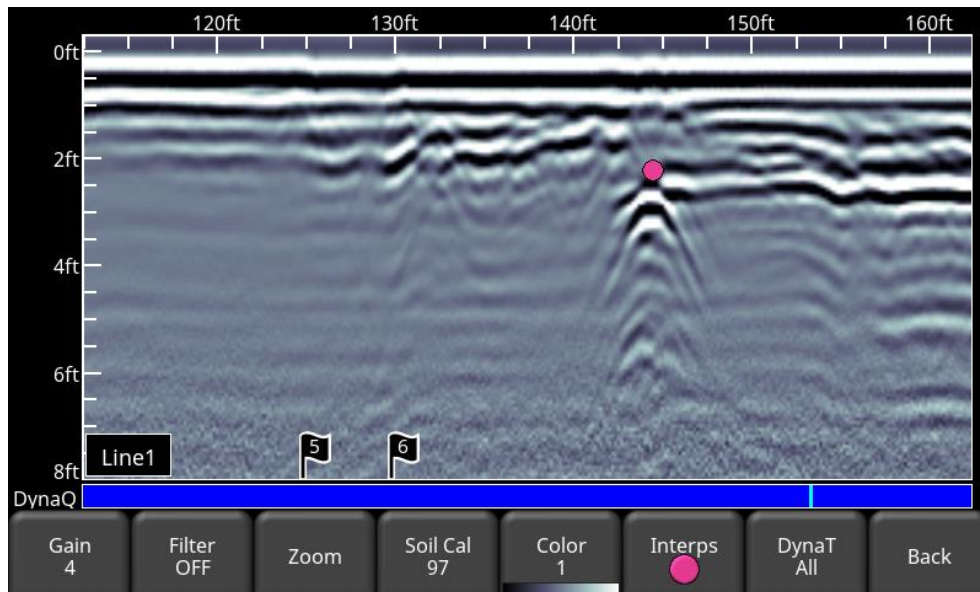

Figure 8-2: Changing LineView settings from within SliceView.

Press **Back** to return to SliceView. Any changes made will be reflected on the GPR line in SliceView mode. If you change the Soil Cal or Zoom (depth), this will cause the depth slices to be re-processed.

Users may want to change these display settings to make it easier to correlate line scan data with depth slices.

8.3 Color

This heading has two button functions beneath it:

- a) **Color Palette** - The number corresponds to the color palette used for the depth slice image. Pressing this button cycles between the 9 available color palettes available on the system.
- b) **Color Sensitivity** - cycles between **LOW**, **MEDIUM** and **HIGH**. A setting of HIGH is useful for revealing weaker targets which can sometimes be difficult to see. Setting to LOW will help “clean up” the data and only show the strong targets, but will hide some of the weak signals so be careful when setting to LOW. Figure 8-3 shows the variations in color sensitivity.

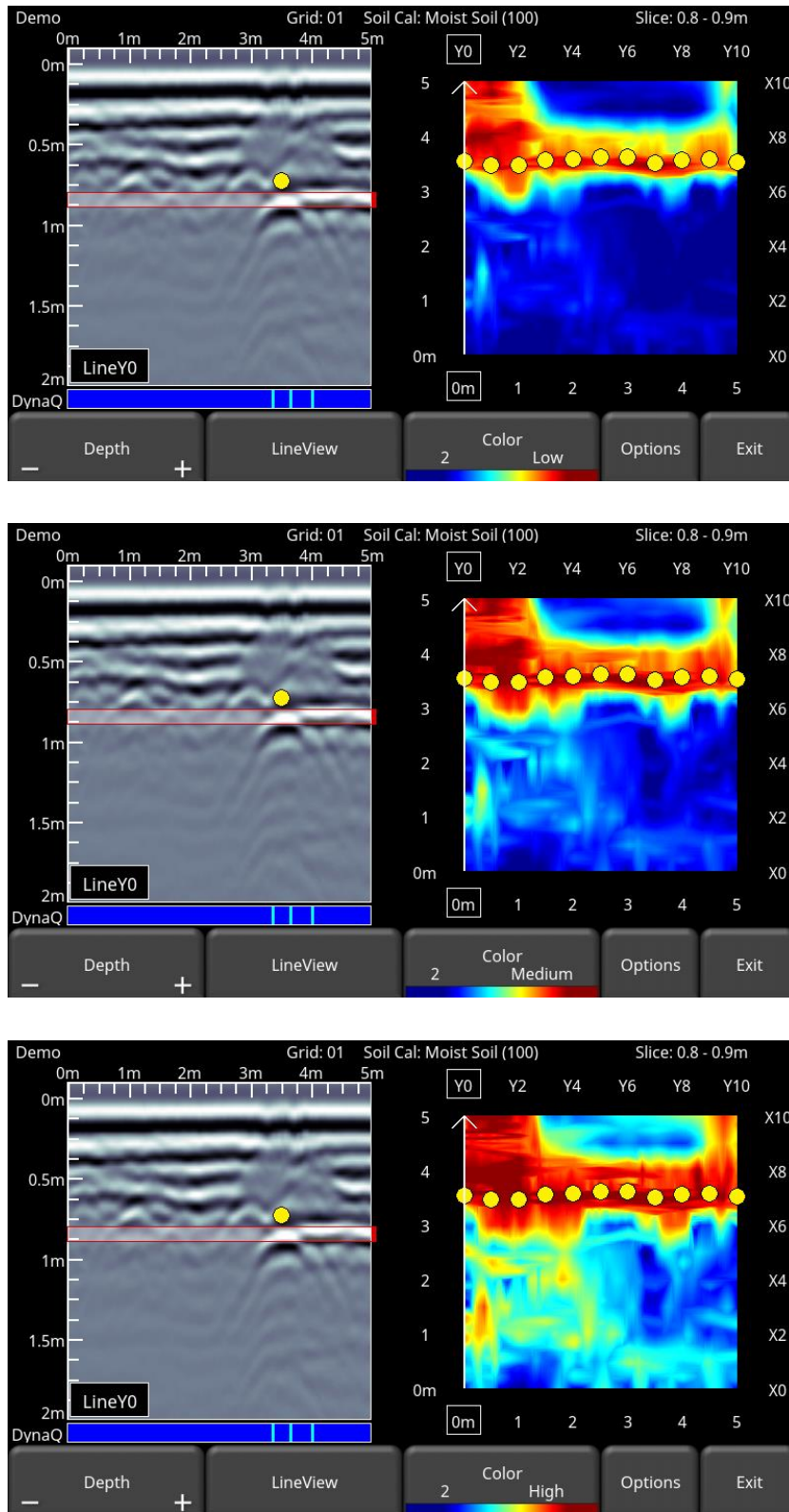

Figure 8-3: Varying the sensitivity, from top to bottom: Low, Medium and High settings. High shows more subtle targets but may sometimes appear cluttered while the Low setting only displays the strongest targets so be cautious when using it.

8.4 Options

8.4.1 Grid Lines

Pressing this button overlays grid lines on the depth slice image, and cycles between **ON**, **PARTIAL** or **OFF**. When set to ON, all the collected lines are displayed. When set to PARTIAL, only some of the grid lines are displayed. This may be necessary for some larger grids as having all the grid lines ON tends to obscure the image beneath (Figure 8-4). The currently selected line is always shown in white.

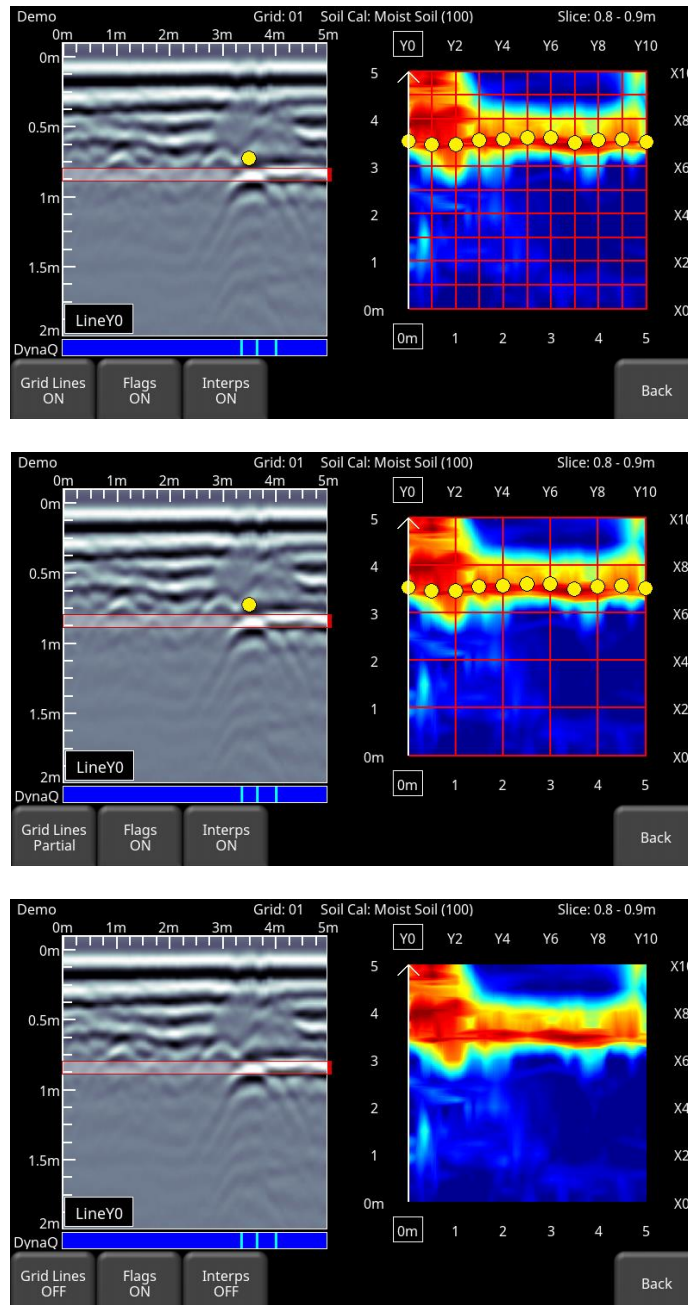

Figure 8-4: Varying the Grid Lines, from top to bottom: ON, PARTIAL and OFF settings.

8.4.2 Flags

Pressing this button toggles on and off between displaying flags on the line scan data and the depth slice.

8.4.3 Interps

Pressing this button toggles on and off between displaying Interps on the line scan data and the depth slice.

8.5 Recollecting lines

After looking at the grid data in SliceView you may discover that one or more grid lines need to be recollected (for example, maybe the starting position was offset). If so, you will need to enter the Grid Scan menu again and select the appropriate grid number and press Start (the grid number will be in red, since data exists).

Select the grid line that needs to be recollected. When you press **Start**, it will display a prompt confirming if you want to overwrite the line. After recollecting the grid line(s), press the **SliceView** button to re-process the grid data.

9 MapView

MapView is a unique feature that allows the user to graphically view the path travelled by the system, and any flags or interpretations made. This is helpful in determining the linearity and consistency of buried objects. It will also display depth slices from a grid collection.

A common use of this feature is to snake back and forth over a given area. Each time you cross a target producing a hyperbola, click on the top of the hyperbola to add an interpretation. If the object is a linear feature, all the interpretations will line up when viewed in MapView.

MapView only works if GPS data is collected with the GPR data. This is what allows the lines and/or grids to be positioned correctly (with the right orientation).

If you use the internal GPS, only grid data will be shown in MapView. If an external GPS is connected, both line and grid data will be shown.

9.1 Accessing MapView

MapView can be accessed the following ways:

- From the main screen. Remember that in the Enhanced configuration, MapView is *project* based, meaning it will display all lines and grids that are present in a given project.

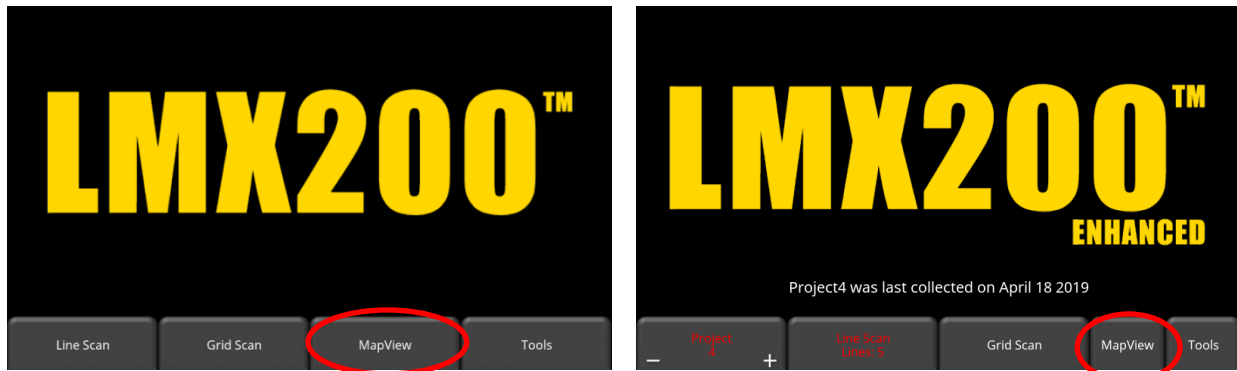

Figure 9-1: Accessing MapView from the main screen: a) LMX200 on left and b) LMX200 Enhanced on right

- From the Line Scan screen, using the SplitView features. Details of SplitView are explained in [Section 6.6](#).

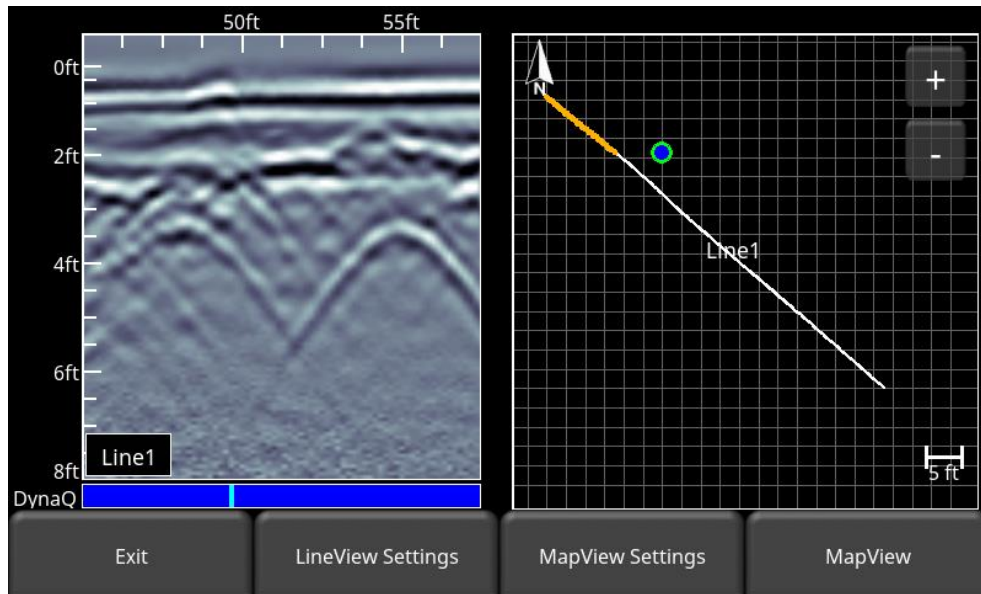

Figure 9-2: Accessing MapView from the SplitView screen in Line Scan

9.2 MapView screen

Regardless of how you enter MapView, you will see an image similar to the one in Figure 9-3. The available options are described below:

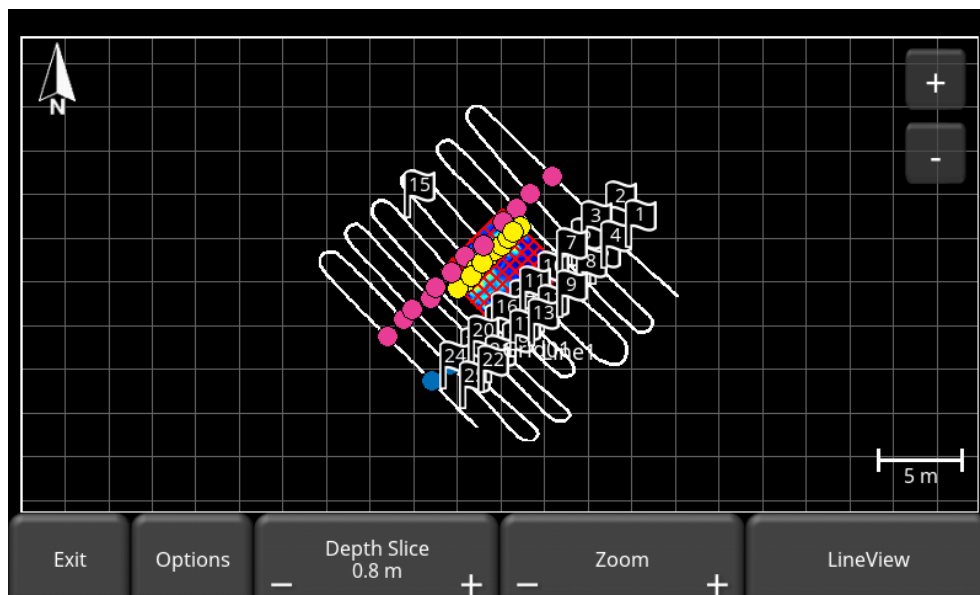

Figure 9-3: MapView screen

- If a grid is collected and depth slices have been processed, this button is available (otherwise it is greyed out). Pressing the +/- buttons under Depth Slice will increase or decrease the depth of the depth slice currently displayed

- Pressing the **+/-** buttons under **Zoom** will zoom the image accordingly. Alternatively, you can also press the **+/-** buttons in the top right of the screen. To reposition the image in the middle of the screen, simply swipe the screen until the image is positioned properly.
- Pressing LineView will take you to LineView display (Figure 6-4). It will always take you to the highest line number for that project.
- Pressing Options will display the screen shown in Figure 9-4 allowing you to customize the layer view. This is explained in the section below.

To reposition the image at any time, simply swipe the screen until the image is positioned properly.

9.2.1 Options (Layer views)

Pressing the **Options** button will allow you to customize what is shown in the MapView display. The screen will be split between the Layer options on the left and the MapView display on the right (Figure 9-4).

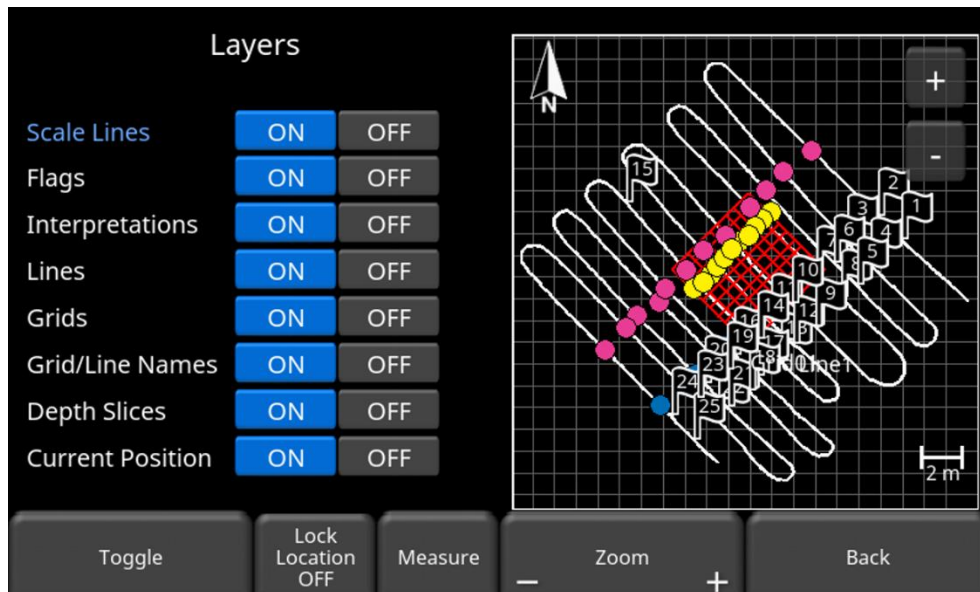

Figure 9-4: Setting layer options in MapView

Press the **ON** or **OFF** button beside each option to show or hide that particular feature on the display on the right. Alternatively use the Up and Down arrows on the 4-way directional keypad to select the desired feature, then press the **Toggle** button on the bottom of the screen to turn that feature on or off.

Each layer feature is described below:

- Scale Lines – controls the display of the background grid lines. These are used as a scale reference.
- Flags – controls the display of flags
- Interpretations – controls the display of all interpretations

- Lines – turning this off will remove all collected lines from the display (white lines in Figure 9-4)
- Grids – turning this off will remove all grids (red grid in Figure 9-4)
- Grid/Line Names – the name of each line and grid is shown beside it. Turning this off will remove this name display
- Depth Slices – if the depth slices are processed, they can be displayed or turned off
- Current position – during data collection and review, the current position is indicated on the screen by a blue dot with a green circle. Press OFF to hide the current position.

For example, the image in Figure 9-5 shows most layers are turned off, with the exception of lines and depth slices.

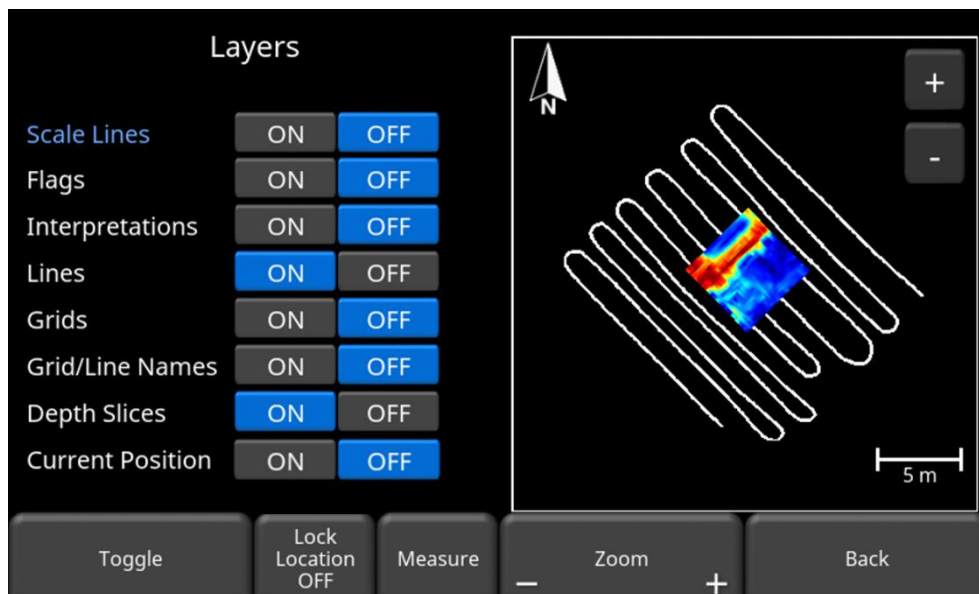

Figure 9-5: Example of hiding some layers

When collecting data in the SplitView screen, the **Lock Location** button is available. This button controls whether the display in the MapView window is locked or moves with the user's position. If **Lock Location** shows OFF, the current status is ON, and pressing the button will turn the status to OFF. When the status is ON, the MapView window is "locked", so if you move outside the limits of the displayed window, the screen will not center itself. Instead, a green arrow will appear in the window indicating that your current position is off the screen (Figure 9-6). The direction of the arrow points towards your current position. You can still move the screen position by touching it and using your finger to pan the window in the desired direction.

If the button shows **Lock Location ON**, the display is "unlocked". This means the MapView display centers itself on your current position as you are moving, such that the position indicator (blue dot with the green circle) always remains in the center of the window. In this mode, however you cannot touch and move the MapView window position.

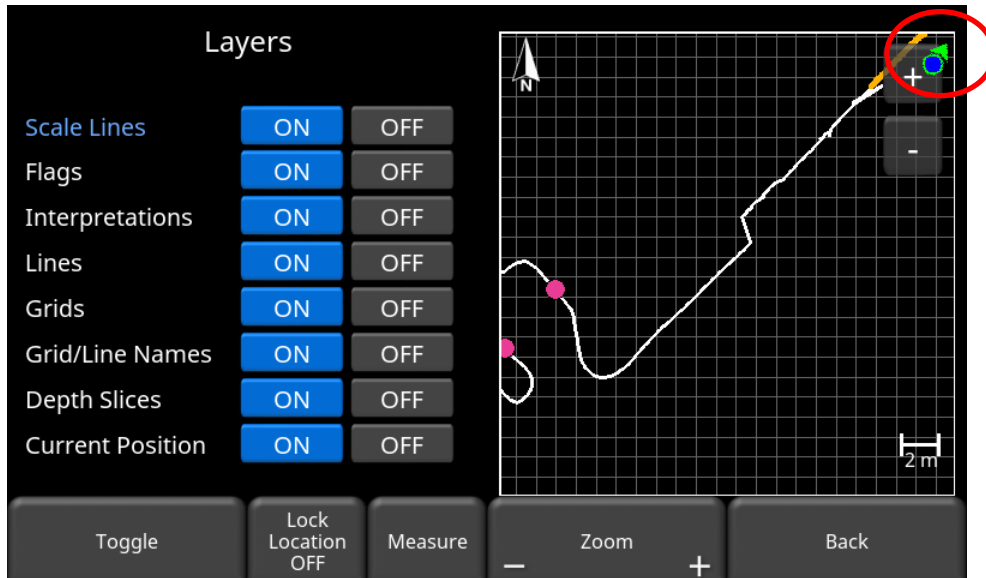

Figure 9-6: With the Lock Location enabled, the MapView display is locked. It shows an icon (in the red circle) when the user's current position is outside of the display.

When the **Measure** button is pressed, it is highlighted in blue. During this time, you can touch the screen and drag your finger a certain distance to get a measurement value for that distance. The distance value is displayed in the bottom left corner in yellow of MapView (Figure 9-7). Pressing the Measure button again exits from Measure mode and removes the yellow measured line and the measured value.

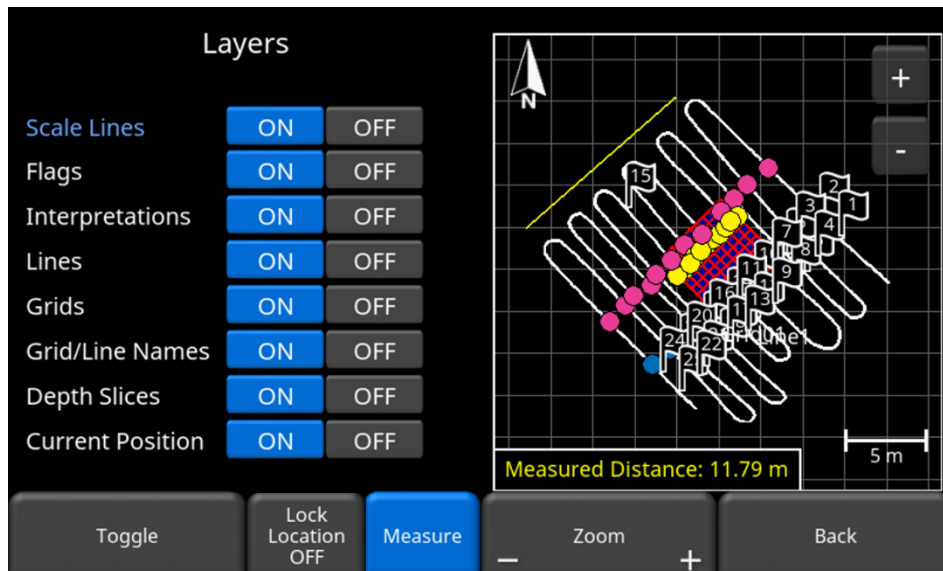

Figure 9-7: Using the Measure tool to draw a line on the screen

Where there are multiple lines and grids, the MapView could look like the example in Figure 9-8.

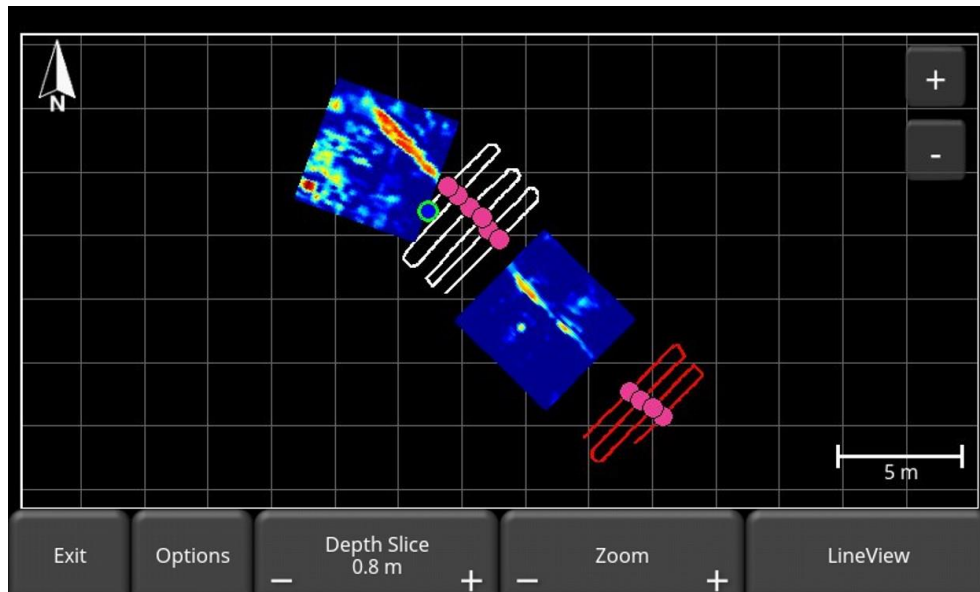

Figure 9-8: MapView showing multiple grids and lines

However, if lines/grids in a project (or any lines/grids in an LMX200) are collected far apart, MapView will only display them if they are collected within a 2.5km radius of the currently selected line. In this case, the data shown in the MapView display will follow the rules in the order below:

- Centre around the currently selected line or
- Centre around the highest line number collected with GPS or
- Centre around the highest grid number collected with GPS

If data exists outside the 2.5km radius, it will display the error message shown in Figure 9-9.

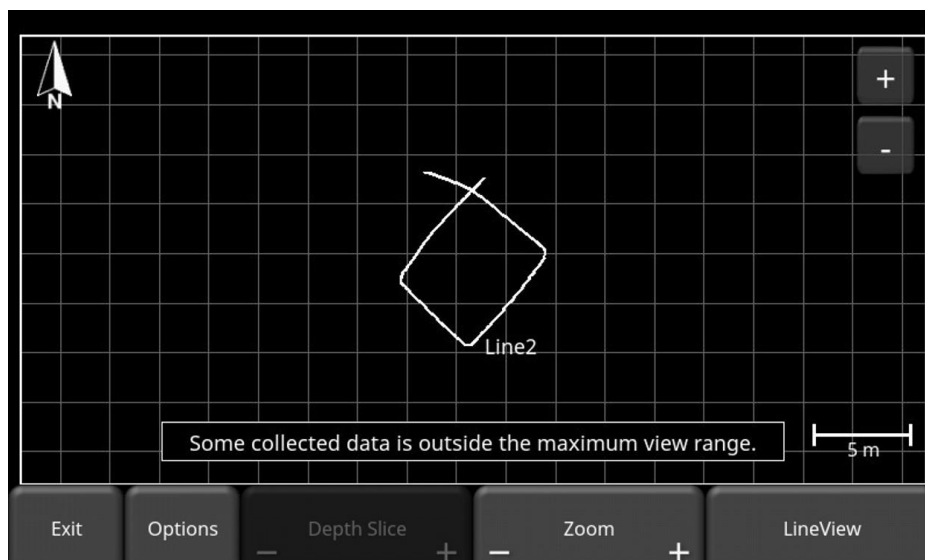

Figure 9-9: Warning message that some data is outside the MapView display range

10 Capturing Screens & E-mailing Mini-Reports

10.1 Capturing Screens

If you would like to save an image of the current screen in Line Scan, Grid Scan, SliceView or MapView, press the **Camera** button on the Display Unit. This saves the screen as a Screenshot image (.JPG), which can be viewed in any third-party viewing software. If any GPS is enabled, the screenshot image for depth slices will contain also a geo-tagged reference. However, for geo-tagging line scan images, you must be using an external GPS.

If you are not connected to a Wi-Fi network, a message appears confirming the filename of the saved image (Figure 10-1).

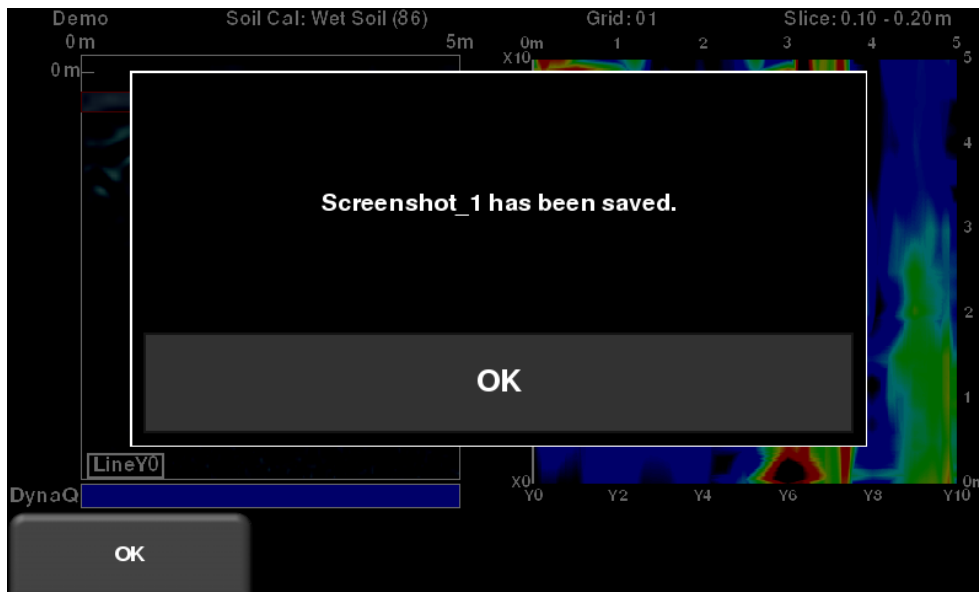

Figure 10-1: Message displayed after pressing the camera button on the Display Unit to capture the screen (no Wi-Fi present).

If you are connected to a wireless network and have a sending e-mail address configured, the user will see the message in Figure 10-2, asking if you would like to email the screenshot and prompts you to enter the email address. The email address defaults to the last one entered. Tapping on the address box brings up an on-screen keyboard and allows you to enter a new email address. Pressing the “...” button to the left of the e-mail address displays the last 5 e-mail addresses used, allowing the user to easily select a recent email address, rather than re-entering it.

Screenshots can always be e-mailed at a later time from the Screenshot Gallery ([Section 4.3.1](#)).

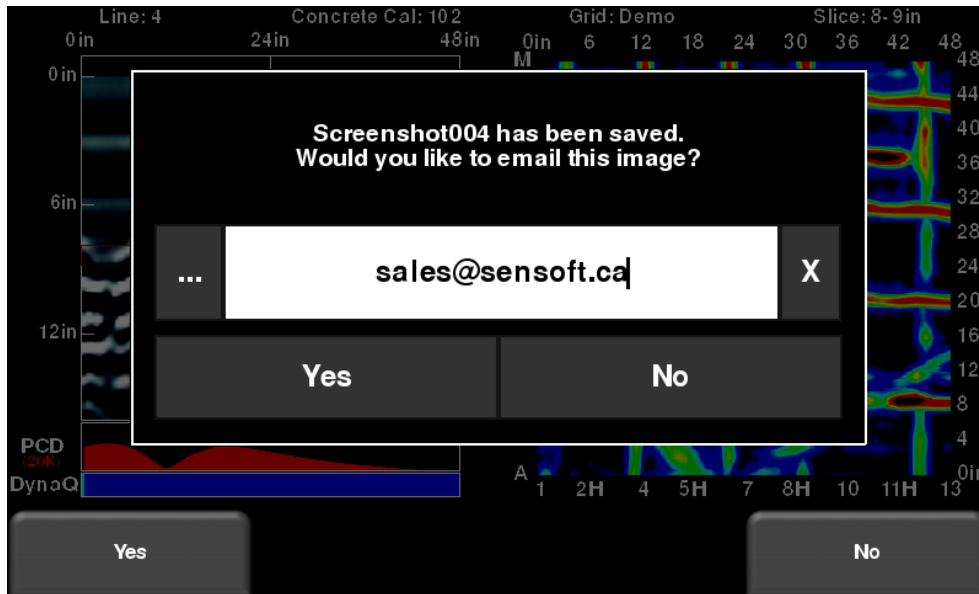

Figure 10-2: Message after pressing the Camera button on the Display Unit to capture the screen with Wi-Fi enabled and a connection to a wireless network. The user can enter an email address to send the mini-report to.

10.2 Using the Hotspot on your Smartphone

If a Wi-Fi signal is unavailable, you may be able to use your Smartphone as a Wi-Fi access point, by creating a Personal Hotspot. If you are experiencing difficulty connecting to a cell phone Personal Hotspot, ensure that the phone is in discovery mode while connecting. On iPhone (iOS 9.0), for example, this involves going to **Settings - Personal Hotspot**. Ensure that the Personal Hotspot setting is turned on, and wait on this screen until the LMX200 connection has been established. Once you have received confirmation on the Display Unit, the cell phone can resume normal use.



Note that when setting up a Personal Hotspot, you may be disconnected from any Wi-Fi networks. Vice-versa, if you have a Personal Hotspot setup, attempting to connect to a Wi-Fi network may disconnect your personal hotspot.

10.3 Mini-Reports

When a screenshot is e-mailed, it is sent as part of a mini-report. This mini-report also contains a table with information about the collected data including the settings used, date & time (Figure 10-3)

LMX200™ Mini Report

Project	Demo
Screen Capture Number	3
Screen Name	Grid Scan
Date Collected	April 17 2019 8:56 AM
Mode	SliceView
Grid	Grid01
Grid Size	5 x 5 m
Grid Spacing	0.5 m (0.5 m)
Soil Cal	Moist Soil (100)
Slice Depth	0.8-0.9 m
Slice Color Palette (Gain)	2 (Low)
Grid Line Visibility	OFF
Selected Line	LineY1
Depth	2.0 m
Line Color Palette	1
Filter	ON (3)
Gain Level	4
DynaT	All



Your screen capture is attached to this email.

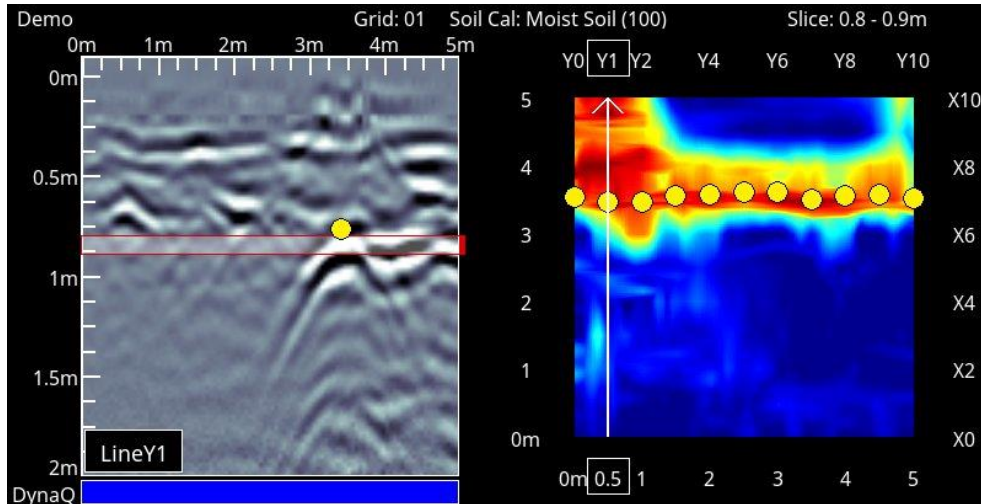

Figure 10-3: Example of a Mini-Report

11 Transferring Data to a PC

Data can be exported to a PC by inserting a USB drive into the USB port (Figure 11-1).



Figure 11-1: Insert a USB memory stick into the USB port on the Display Unit to export data.

Once the USB drive is recognized, a message will appear telling you that a drive has been inserted and if you wish to export your data to it (Figure 11-2). Click **Yes**.

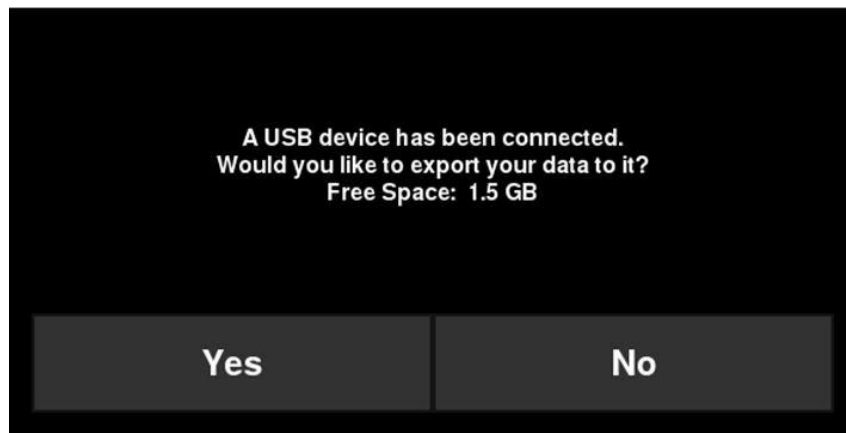

Figure 11-2: When a USB drive is connected to the Display Unit, a message opens asking if you would like to export all your data to it. Select **Yes** to transfer immediately. If you select **No**, you can export the data later by going to the **Setup > File Management** menu option.

If there are grids that were collected, but not processed, it will alert you after you select **Yes** to exporting the data (Figure 11-3). This is important, as unprocessed grids will not automatically show up in EKKO_Project as depth slices (you will need an additional module to view them) – see [Section 11.6](#).

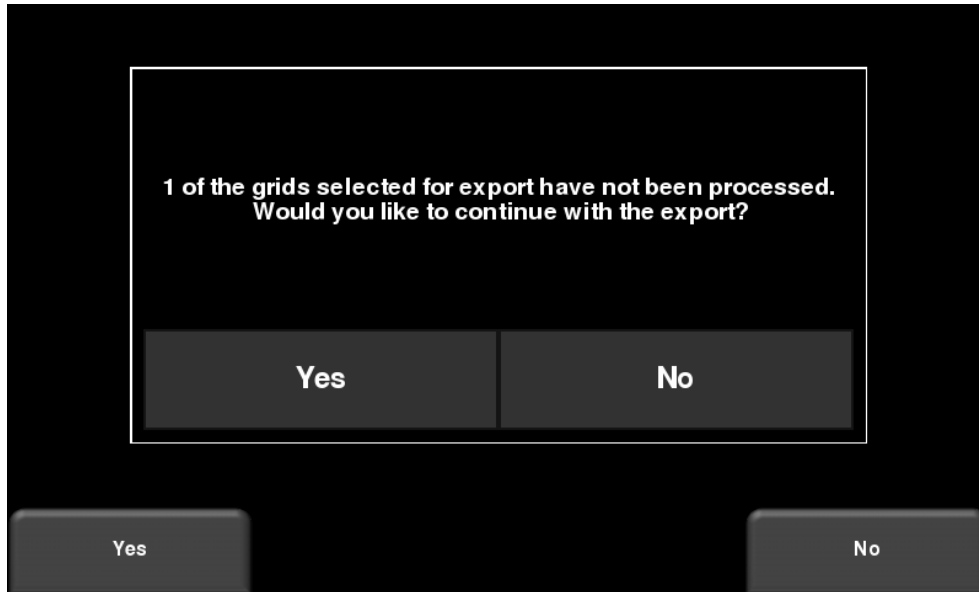

Figure 11-3: Insert a USB memory stick into the USB port on the Display Unit to export data.

Alternatively, if you want to export data from a specific Project (LMX200 Enhanced only), you can select No for the time being. Later on, when you are ready to export your data, from the main menu select **Setup > File Management** and press **Export Data** ([Section 4.3.4](#))

11.1 Formatting USB Sticks

There may be times when a USB stick is not recognized by the LMX200. In this case, you may need to format the USB stick. Ensure that it's formatted as FAT/FAT32 (NTFS will not work). Also ensure that there are no hidden or write-protected partitions on the USB drive.

If the problem persists after formatting, try another USB stick.

11.2 Directory Structure

The directory structure on the USB drive can be viewed on your PC, and will look as follows:

- GPR Data
 - LMX200
 - Export01
 - Project1
 - Screen Shots
 - All Screenshots as .JPG files
 - Project1.GPZ file
 - Project1.KMZ file
 - Project 1 Field Interp Report.CSV
 - Project2
 - Screen Shots
 - All Screenshots as .JPG files
 - Project2.GPZ file
 - Project2.KMZ file
 - Project 2 Field Interp Report.CSV
 - System Info
 - Exportxx
 - Projectx
 - Screen Shots
 - All Screenshots as .JPG files
 - .GPZ file
 - .KMZ file
 - Project xx Field Interp Report.CSV
 - System Info

Each successive export of data will create a new directory called ExportXX, where XX is incremented by 1 from the previous directory. The actual GPR data files are all contained in a .GPZ file. This can be opened by the EKKO_Project software.

If data was collected with GPS (internal or external), a .KMZ file is also generated. This contains positional information and can easily be opened in Google Earth™.

If any Field Interpretations were added during data collection, these are saved in a .CSV file. This is a spreadsheet file, which shows the positional information of any Interps made.

The System Info folder contains an APP.LOG file and a System Summary diagnostic report. The APP.LOG file contains important information about system operation and may be requested by Sensors & Software to help troubleshoot any issues.

Some of the output files are described and shown below.

11.3 Field Interpretations file

If any interpretations are made a Field Interp Report file is created. This file is a CSV (Comma separated values) format, most commonly opened with Microsoft Excel.

The file will list any Interps and Flags added to data in the field. The position, depth and colour of each Interp is listed, along with GPS positions (if a GPS was connected). A sample output for this file is shown in Figure 11-4.

	A	B	C	D	E	F	G	H	I	J	K
1	Name	Count									
2	Pink	5									
3											
4	Tool	Interpretation	GPR Line	Position (m)	Depth (m)	Velocity	GPS-Easting (29S)	GPS-Northing (29S)	Latitude	Longitude	GPS-Elevation
5	Point	Pink	Lineset/line4	2.01	0.48	Wet Soil (0.08 m/ns)	484187.65	4298429.14	38.8345202	-9.1821844	16.63
6	Point	Pink	Lineset/line4	3.02	0.32	Wet Soil (0.08 m/ns)	484187.81	4298429.13	38.8345201	-9.1821826	16.6
7	Point	Pink	Lineset/line4	4.21	0.27	Wet Soil (0.08 m/ns)	484188.05	4298428.97	38.8345187	-9.1821798	16.59
8	Point	Pink	Lineset/line4	5.16	0.51	Wet Soil (0.08 m/ns)	484188.38	4298428.8	38.8345172	-9.1821759	16.56
9	Point	Pink	Lineset/line4	6.89	0.62	Wet Soil (0.08 m/ns)	484188.38	4298428.8	38.8345172	-9.1821759	16.56
10											

Figure 11-4: Contents of a sample Field Interp Report file

11.4 Google Earth™

Anytime a GPS is used, a .KMZ file is included as part of the exported data. If the internal GPS was used, you will only see screenshots and a layout of the grid (if a grid was collected). Clicking on the yellow camera icon in Google Earth™ will display the screenshot image (Figure 11-5).

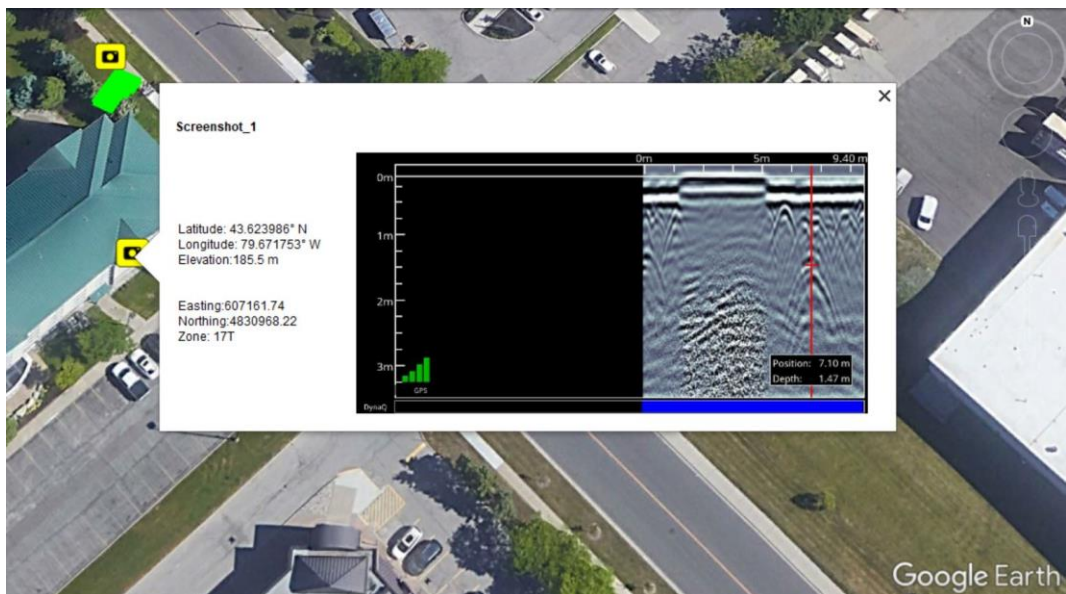

Figure 11-5: Google Earth™ image, showing a layout of the grid and some screenshots taken

Data collected with an external GPS will also show the path walked for any line scan data as well as any Interpretations and Flags (Figure 11-6).



Figure 11-6: Path travelled with Interpretations, collected using an External GPS

Opening the data in EKKO_Project ([Section 11.6](#)) and creating depth slices, will allow you to export those slices to Google Earth™ (Figure 11-7).



Figure 11-7: Depth slice displayed in Google Earth™

11.5 System Summary Report

The System Summary report is a PDF file, which lists system usage information, serial numbers and when system tests were done and their pass/fail status. An example file is shown below:

LMX200™

System Usage Summary April 18 2019

Usage Statistics

Data Exports	2
Grids Collected	4
Average Grid Area	12.5 m ² / 134.5 ft ²
Average Grid Collection Time	1 minutes 52 seconds
Total Grid Area	50.0 m ² / 538.2 ft ²
Total Grid Line Distance	140.0 m / 459.3 ft
Lines Collected	46
Average Line Length	251.2 m / 824.3 ft
Average Line Collection Time	3 minutes 36 seconds
Total Line Collected	11557.1 m / 37917.2 ft
Screenshots Saved	30
Wi-Fi Reports Sent	19
System Power Cycles	35
Operation Time	10 hours
Total Distance Collected	11697.1 m / 38376.5 ft

System Information

Display Unit (DVL) Serial Number	0070-7906-0001
GPR Sensor Serial Number	0077-7547-0024
Application Version	v1.7.796 (2015-00154-06)
OS Version	2.08.512 (2017-00041-08)
GPR Firmware Version	2.004 (2013-00001-01)
Hardware ID	001EC0AF2D9B
Licenses	Enhanced

System Tests

Odometer Test	18 April 2019	Passed - 1101.0 t/m
GPS Test	18 April 2019	Passed - External
Keypad Test	18 April 2019	Passed
Audio Test	18 April 2019	Passed
Touch Screen Test	18 April 2019	Passed
GPR Sensor Test	18 April 2019	Passed

11.6 EKKO_Project

If you have an LMX200 Enhanced system, any line and grid data collected in a project are saved as a single .GPZ file (e.g. Project1.GPZ). This file can be opened with the EKKO_Project PC software.

EKKO_Project is powerful software that allows you to view, edit, process and ultimately create reports from your GPR data. Grid data that is processed in the field will immediately show up as depth slices in EKKO_Project, as well as the path travelled in MapView.

From the main screen (Figure 11-8), you can access various views and launch modules that give you access to further functionality. Some features shown here are not part of the standard EKKO_Project base software. For more information, consult your EKKO_Project manual or contact Sensors & Software.

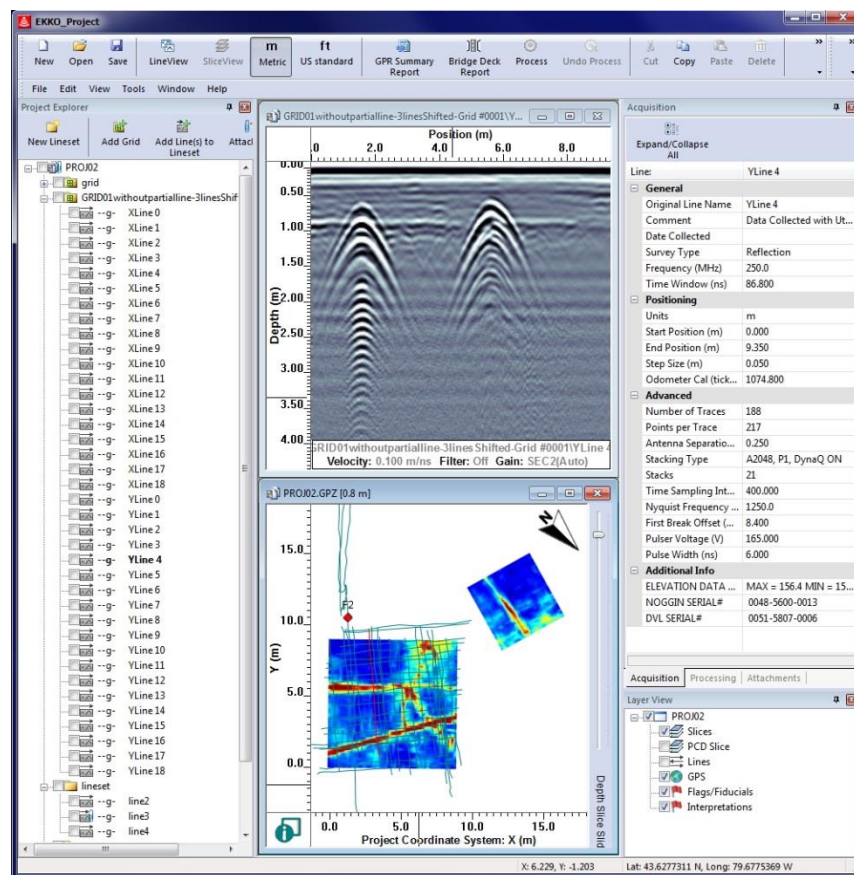

Figure 11-8: Main screen of EKKO_Project

12 Troubleshooting

The LMX200 system is designed to minimize user problems; however, all electronic devices are subject to possible failure. The following are troubleshooting hints which can be referred to if your system fails to operate.

12.1 Power Supply

The most common problem that can occur while trying to run the system is insufficient power. The battery may be dead, have a low voltage or the fuse may be blown.

Once boot up is complete, the colour of the LED will indicate the amount of battery power remaining:

- 100% to 20% = green
- 20% to 10% = orange
- 10% to 0% = red

You can check the battery voltage with a voltmeter. Try to do this while the battery is still attached to the Cart to get a true measure of the voltage while under load (it will be necessary to open the Cart battery case and connect the voltmeter to the positive and negative battery terminals). A fully charged battery will show a voltage of 13.8V, whereas a voltage of 10.8V or lower will not power the system. If the battery has a low voltage or seems dead, try using another battery (if available), or give the battery a good 12-14 hour charge and try running the system again.

If the battery does not charge up to 12 Volts or more, it should be replaced.

Batteries are fused to protect the system. Open the battery case and check that the 10 Amp fuse is OK. If necessary, replace it with one of the spare fuses available inside the battery case.

If the battery seems OK but the system still does not power up, check the battery cable connections and inspect the battery cable for damage.

12.2 System Communications

If the battery is OK and the Display Unit turns on but the GPR sensor does not scan, there may be a communication failure between the Display Unit and the GPR sensor. If an error occurs, an error message will appear. Power Off the system and disconnect the battery.

Make sure the display cable is not damaged, all pins are straight, and there is no dirt or debris in the connector. Ensure that the cable connections are tightly secured. Sometimes vibrations cause the cable connections to slightly loosen and break contact leading to errors. Disconnecting the cable and reconnecting it may provide a better contact and solve the problem. Plug in the battery, turn on the system and try scanning again.

If the Battery, Battery Cable and Display Cable are OK, the problem is either a failure of the Display Unit or the GPR sensor. These units have no user-serviceable parts so they will have to be returned to the vendor for inspection and repair.

12.3 System Overheating

The GPR system is designed to operate to a maximum *internal* temperature of 70°C or 158°F. In situations of high ambient temperatures or long exposure to direct sun, this maximum internal temperature may be exceeded and cause the system to fail.

If you suspect that the GPR sensor is overheating, shut it off and give it a chance to cool down in a shady location before trying to run it again.

If the situation is such that the high temperatures or direct sun cannot be avoided, it may be a good idea to put some sort of shade over the GPR sensor.

12.4 Display Unit Problem

If the Display Unit does not power up, check the battery power and all cable connections. If that doesn't work, contact the manufacturer.

12.5 Wobbly Wheels

If, over time, a wheel becomes wobbly, the wheel nut will need to be manually tightened.

For the rear right wheel only (which is connected to the direct drive odometer), insert a large slotted screwdriver into the end of the axle (there's already a slot there for it) and use a large wrench to slightly tighten the wheel nut. The nut only has to be turned slightly, 1/8th -1/16th of a turn is usually enough. Spin the wheel to make sure it's still free and not too tight.

12.6 Creating a Test Line for Data Quality

After receiving the system and getting comfortable with its operation, one of the best ways of detecting any problems is to collect a line of data at a convenient, easily accessible location. The line does not have to be too long but one screen is a good guide. This data line should be saved electronically and perhaps plotted out on paper and dated. If there is a suspected problem with the system, this test line could be collected and compared with earlier tests. When comparing data, take into account weather and environmental conditions, which could skew the comparisons slightly.

12.7 Contacting the Vendor for Service

When returning the system to the Vendor, have the following information available:

- 1) GPR sensor Serial Number displayed at the top of the **System Settings Screen**.
- 2) A brief description of when the error is happening and the operating conditions (temperature, humidity, sunshine, system settings, etc.).
- 3) Include photos and/or videos to document the occurrence of error messages.
- 3) APP.LOG file – this is downloaded to your computer during data export

13 Care & Maintenance

13.1 Battery Care

The LMX200 uses a 9-Amp-hour, 12-Volt sealed lead acid battery. It is fused with a 10 Amp fuse to protect it from short circuit damage.

The battery unit should run the LMX200 continuously for 6 hours before recharging is necessary. If long days of data surveying are typical, a second battery unit may be useful.

The battery is strapped onto the cart base and is normally recharged without removing it from the cart. However, the battery can be easily removed for maintenance or for recharging, if required.

If batteries are maintained in a charged condition, they will give long life and reliable service. Improper use and lack of maintenance will greatly reduce their life.

Sealed lead acid batteries should **NEVER** be left in a discharged condition for any period of time. Charge the batteries as soon as possible after use.

Charge the battery at room temperature whenever possible.

The LMX200 has a voltage monitoring circuit that will turn off the unit when the input voltage drops below 10.8 volts.

If a battery has been deeply discharged or left in a discharged condition for some period of time it may not accept charge immediately when it is connected to the charger (the fast charge light will not illuminate). If the fast charge light does not come on within 6 hours the battery should be considered damaged and should be discarded.

Do not assume that a battery that is still charging after 8 hours is nearing the end of its charge cycle. Typical charging time for an empty battery is 12-14 hours from the start of fast charge.

Ensure that the batteries are fully charged before storing. If practical, store the batteries in a cool place, 10°C (a refrigerator is ideal), but make sure the temperature is not likely to drop below -30°C or the electrolyte may freeze and possibly split the case.

13.2 Cable Care

With the use of this product in rough, dusty and outdoor environments, users can minimize potential downtime if they care for cables and treat connectors with respect.

- 1) The cable connectors as well as the connectors on the GPR Sensor and Display Unit need to stay clean and free of dust and moisture. Use a brush or air spray to clean dust, lint and other foreign particles from these connectors.
- 2) The power and odometer receptacles on the top of the LMX200 are watertight, but do not allow water to get into the receptacle by connecting the battery and odometer cables in the rain
- 3) After working in rainy conditions, disconnect the cables and check for water in the receptacles. Remove the water or allow to air dry, if necessary. Never allow the system to sit in rainy conditions for long periods of time.
- 4) When the system is not being used, make sure the connections are protected to prevent dust and moisture from collecting inside. If the connectors are exposed, cover them with some sort of dust cap.
- 5) Cables and connectors are not designed to suspend or tow or otherwise carry the weight of systems. They are part of the electronic circuit and should be treated accordingly. When not in use they should be placed in their storage box.

13.3 Skid Pads

The bottom of the GPR Sensor is covered with one large wear-resistant skid pad. The skid pad is designed to take the majority of the abrasive wear. If the pad wears down enough, the less-resistant plastic housing may start to wear. If this occurs, it is best to replace the skid pad. It is easily removed with a screwdriver and a new one can be purchased from the vendor.

13.4 Odometer

The odometer should be periodically calibrated (refer to Section 4.4.6) to ensure accuracy.

13.5 Storage Cases

Equipment that is transported and stored loosely is more susceptible to damage. All equipment should be stored in its shipping case or a storage box. Sensors & Software has optional shipping cases available for all LMX200 systems.

13.6 Upgrading Embedded Software on Display Unit

From time to time, Sensors & Software may release new software for the Display Unit. The instructions below describe how to update this software. Please note that this procedure will **erase all GPR data** from the system, so export any valuable data before continuing.

1 Download

the zip file provided by Sensors & Software into a folder on your PC.

2 Insert

a clean USB stick into your PC.

3 Unzip

the file by double clicking the file in Windows Explorer.

4 Copy

the unzipped folder to the root of the USB key. The resulting folder structure on the USB key should be:

```
dvl-apps
  app1
    PACKAGE_NAME.en
    PACKAGE_NAME.pkg
```

where PACKAGE_NAME is the name of the item to be installed. An example of the Conquest 100 installation files are shown below:

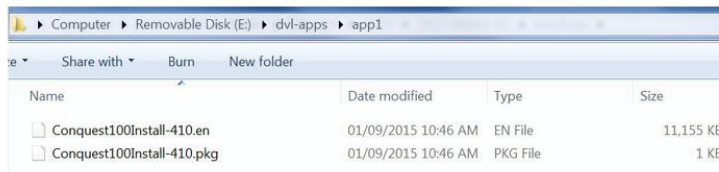

Name	Date modified	Type	Size
Conquest100Install-410.en	01/09/2015 10:46 AM	EN File	11,155 KB
Conquest100Install-410.pkg	01/09/2015 10:46 AM	PKG File	1 KB

5 Turn off

the Display Unit. Remove the USB stick from your PC and insert it into the USB port on the side of the Display Unit.

**6 Turn On**

the Display Unit. You will see a list on the screen showing all software installations. The USB key may hold one or more packages which are displayed as numbered items:

```
Select app to run:
1. PACKAGE_NAME
```

7 Select

the package to run by pressing the associated numbered key on the Display Unit. The selected software will now be installed. The process may require multiple reboot cycles initiated by the system. When complete, the system will shut down, and the red light on the front of the Display Unit will turn off.

8 Remove

the USB stick from the Display Unit.

9 Turn On

the Display Unit and access the System Info screen to verify the newly installed version number.

14 Parts List & Accessories

14.1 Spare Parts

The following is a list of spare parts available for purchase, with labelled diagram below that:

122-10-2377	Cart Wheel
100-55-0023	Battery with Case
100-53-0098	Display Unit Tray
100-52-0108	Display Cable
126-77-1450	Skid Plate
126-77-2010	Battery Cable
100-55-0027	Battery Charger
126-78-0400	Sensor Support Strap
100-22-0084	GPR Sensor
100-22-0085	Display Unit
126-85-0670	Cart Handle
126-81-1600	Cart Base
126-78-0160	Battery Strap
122-10-1200	Display Unit Tray Knob Screw
122-00-0046	

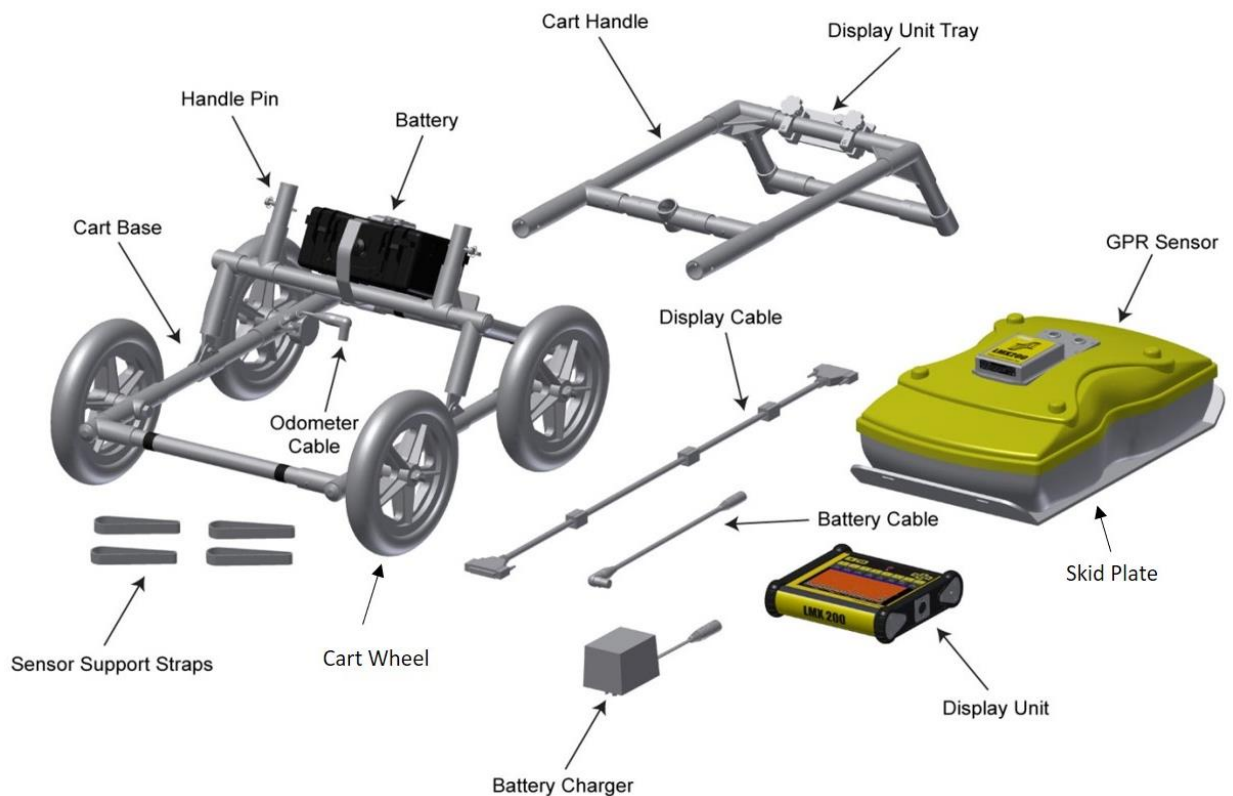

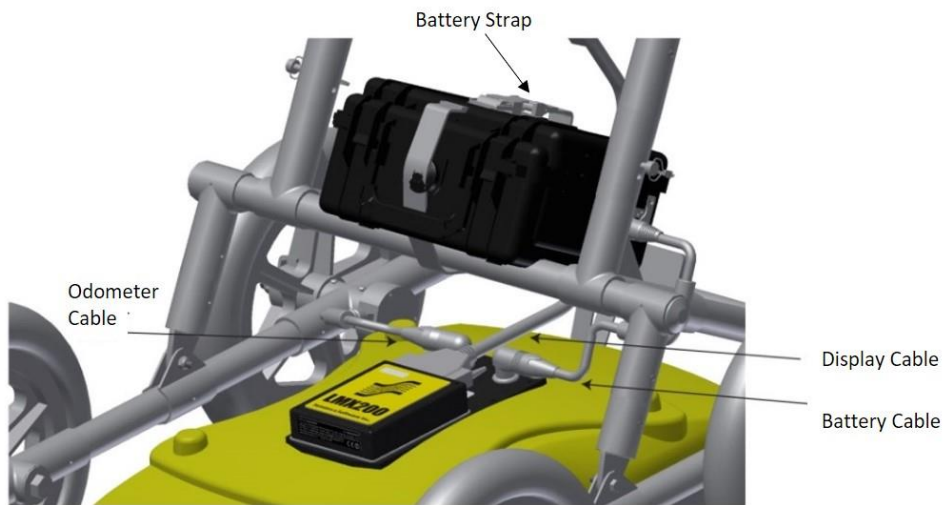
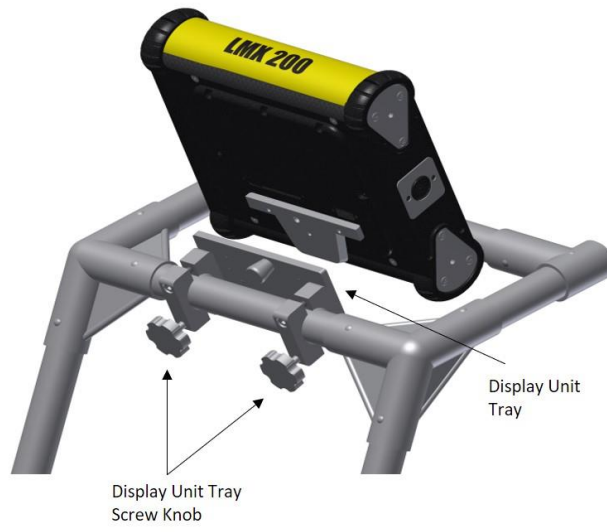

14.2 Accessories

The following accessories are available for purchase



100-60-0058 LMX® Series ATA Shipping Case (with DVL Bag)



100-55-0027 Spare Battery Charger



100-55-0023 Spare Battery



100-60-0066 Deluxe Display Unit Carrying Case



100-54-0138 LMX200™ Topcon GPS Package

100-12-0052 LMX200™ Enhanced Upgrade Package



Software Upgrade

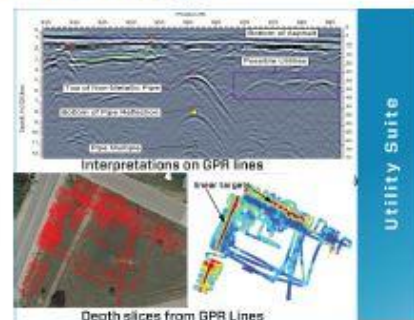

100-11-0118 EKKO_Project™ Utility Suite Software License
 • Includes LineView, SliceView and Interpretation modules

15 Technical Specifications

Specifications	Values
GPR Sensor size	630 x 410 x 230 mm (25 x 16 x 9 in)
GPR Sensor weight	5 kg (11 lbs)
Display Unit weight	2.83 kg (6.24 lbs)
Display Unit screen	8.0" high-visibility, sunlight-readable diagonal LCD display with touch screen Adjustable backlighting 1500 NIT and 800:1 contrast ratio
Battery weight	3.6 kg (7.9 lbs)
Wireless	Integrated modules: Wi-Fi (IEEE 802.11 b,g,n) GPS/GLONASS
Audio	Built-in speaker - 85dBA speaker w/volume control
Battery	Lead acid gel cell Battery Life: 4-6 hours Battery Capacity:9.0 Ah
Charger	Built-in charger with status indicator Universal AC mains charger input: 100-240V \sim , 1.5A, 50/60Hz Output: 12 Volts @ 3 Amps
Display Unit Input	11-18V --- , 4A maximum
Temperature & Environmental 	Ruggedized, environmentally sealed unit and connections. Ingress protection (IP) rating: Display Unit is rated to IP65 under IEC 60529 Relative Humidity operation (non-condensing): 10 – 90% GPR Sensor and Display Unit operating temperature range: -40 to 50°C Do not use touch screen below -20°C. Use battery charger between 0 and 30°C.
Regulatory Specifications	EMC: FCC, CE, IC, ACA, RSM Safety: TUV

Appendix A: Health & Safety Certification

Radio frequency electromagnetic fields may pose a health hazard when the fields are intense. Normal fields have been studied extensively over the past 30 years with no conclusive epidemiology relating electromagnetic fields to health problems. Detailed discussions on the subject are contained in the references and the web sites listed below.

The USA Federal Communication Commission (FCC) and Occupational Safety and Health Administration (OSHA) both specify acceptable levels for electromagnetic fields. Similar power levels are mandated by corresponding agencies in other countries. Maximum permissible exposures and time duration specified by the FCC and OSHA vary with excitation frequency. The lowest threshold plane wave equivalent power cited is 0.2 mW/cm² for the general population over the 30 to 300 MHz frequency band. All other applications and frequencies have higher tolerances as shown in graphically in Figure B-1.

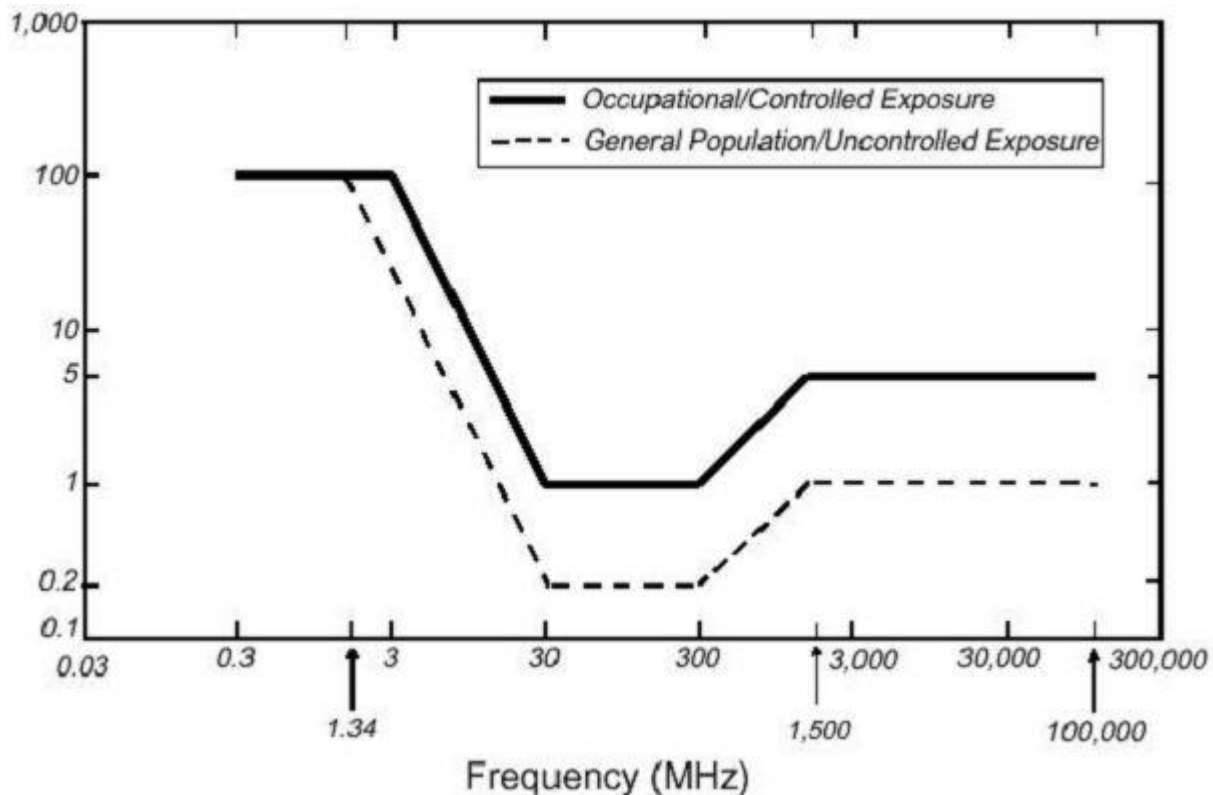

Figure B-15-1: FCC limits for maximum permissible exposure (MPE) plane-wave equivalent power density mW/cm².

All Sensors & Software Inc. GPR products are normally operated at least 1 m from the user and as such are classified as “mobile” devices according to the FCC. Typical power density levels at a distance of 1 m or greater from any Sensors & Software Inc. products are less than 10⁻³ mW/cm² which is 200 to 10,000 times lower than mandated limits. As such, Sensors & Software Inc. products pose no health and safety risk when operated in the normal manner of intended use.

Appendix B: GPR Emissions, Interference and Regulations

All governments have regulations on the level of electromagnetic emissions that an electronic apparatus can emit. The objective is to assure that one apparatus or device does not interfere with any other apparatus or device in such a way as to make the other apparatus non-functional.

The manufacturer test their GPR products using independent professional testing houses and comply with latest regulations of the USA, Canada, European Community, and other major jurisdictions on the matter of emissions.

Electronic devices have not always been designed for proper immunity. If a GPR instrument is placed in close proximity to an electronic device, interference may occur. While there have been no substantiated reports of interference to date, if any unusual behavior is observed on nearby devices, test if the disturbance starts and stops when the GPR instrument is turned on and off. If interference is confirmed, stop using the GPR.

Where specific jurisdictions have specific GPR guidelines, these are described below.

B-1 FCC Regulations

This device complies with Part 15 of the USA Federal Communications Commission (FCC) Rules. Operation in the USA is subject to the following two conditions:
this device may not cause harmful interference and

this device must accept any interference received, including interference that may cause undesired operation.

Part 15 – User Information

This equipment has been tested and found to comply with the limits for a Class A digital device, where applicable, and for an ultra-wide bandwidth (UWB) device where applicable, pursuant to Part 15 of the FCC Rules. These limits are designed to provide reasonable protection against harmful interference when the equipment is operated in a commercial environment. This equipment uses and can radiate radio frequency energy and, if not installed and used in accordance with the instruction manual, may cause harmful interference to radio communications. Operation of this equipment in a residential area is likely to cause harmful interference in which case the user will be required to correct the interference at his/her own expense.

WARNING

Changes or Modifications not expressly approved by the manufacturer could void the user's authority to operate the equipment.

Certification of this equipment has been carried out using approved cables and peripheral devices. The use of non-approved or modified cables and peripheral devices constitutes a Change or Modification outlined in the warning above.

Operating Restrictions

Operation of this device is limited to purposes associated with law enforcement, firefighting, emergency rescue, scientific research, commercial mining, or construction. Parties operating this equipment must be eligible for licensing under the provisions of Part 90 of this chapter.

FCC Interpretation of Operation Restrictions issued July 12, 2002

(FCC Order DA02-1658, paragraph 9)

The regulations contain restrictions on the parties that are eligible to operate imaging systems (See 47 C.F.R. 5.509(b), 15.511(b), and 15.513(b)). Under the new regulations, GPRs and wall imaging systems may be used only by law enforcement, fire and emergency rescue organizations, by scientific research institutes, by commercial mining companies, and by construction companies. Since the adoption of the *Order*, we have received several inquiries from the operators of GPRs and wall imaging systems noting that these devices often are not operated by the users listed in the regulations but are operated under contract by personnel specifically trained in the operation of these devices. We do not believe that the recent adoption of the UWB rules should disrupt the critical safety services that can be performed effectively only through the use of GPRs and wall imaging systems. We viewed these operating restrictions in the broadest of terms. For example, we believe that the limitation on the use of GPRs and wall imaging systems by construction companies encompasses the inspection of buildings, roadways, bridges and runways even if the inspection finds no damage to the structure and construction does not actually result from the inspection; the intended purpose of the operation of the UWB device is to determine if construction is required. We also believe that the GPRs and wall imaging systems may be operated for one of the purposes described in the regulations but need not be operated directly by one of the described parties. For example, a GPR may be operated by a private company investigating forensic evidence for a local police department.

FCC Permitted Mode of Usage

The GPR antenna must be kept on the surface to be in compliance with FCC regulations. Use of the antenna is not permitted if it is lifted off the surface. Use as a through-the-wall imaging device is prohibited.

GPR Use Coordination

FCC regulation 15.525(c) (updated in February 2007) requires users of GPR equipment to coordinate the use of their GPR equipment as described below:

TITLE 47--TELECOMMUNICATION

CHAPTER I--FEDERAL COMMUNICATIONS COMMISSION

PART 15_RADIO FREQUENCY DEVICES

Subpart F_Ultra-Wideband Operation Sec.

15.525 Coordination requirements.

(a) UWB imaging systems require coordination through the FCC before the equipment may be used. The operator shall comply with any constraints on equipment usage resulting from this coordination.

(b) The users of UWB imaging devices shall supply operational areas to the FCC Office of Engineering and Technology, which shall coordinate this information with the Federal Government through the National Telecommunications and Information Administration. The information provided by the UWB operator shall include the name, address and other pertinent contact information of the user, the desired geographical area(s) of operation, and the FCC ID number and other nomenclature of the UWB device. If the imaging device is intended to be used for mobile applications, the geographical area(s) of operation may be the state(s) or county(ies) in which the equipment will be operated. The operator of an imaging system used for fixed operation shall supply a specific geographical location or the address at which the equipment will be operated. This material shall be submitted to:

Frequency Coordination Branch, OET

Federal Communications Commission
445 12th Street, SW, Washington, D.C.
20554

Attn: UWB Coordination

(Sensors & Software Inc. Note: The form given on the following page is a suggested format for performing the coordination.)

(c) The manufacturers, or their authorized sales agents, must inform purchasers and users of their systems of the requirement to undertake detailed coordination of operational areas with the FCC prior to the equipment being operated.

(d) Users of authorized, coordinated UWB systems may transfer them to other qualified users and to different locations upon coordination of change of ownership or location to the FCC and coordination with existing authorized operations.

(e) The FCC/NTIA coordination report shall identify those geographical areas within which the operation of an imaging system requires additional coordination or within which the operation of an imaging system is prohibited. If additional coordination is required for operation within specific geographical areas, a local coordination contact will be provided. Except for operation within these designated areas, once the information requested on the UWB imaging system is submitted to the FCC no additional coordination with the FCC is required provided the reported areas of operation do not change. If the area of operation changes, updated information shall be submitted to the FCC following the procedure in paragraph (b) of this section.

(f) The coordination of routine UWB operations shall not take longer than 15 business days from the receipt of the coordination request by NTIA. Special temporary operations may be handled with an expedited turn-around time when circumstances warrant. The operation of UWB systems in emergency situations involving the safety of life or property may occur without coordination provided a notification procedure, similar to that contained in Sec. 2.405(a) through (e) of this chapter, is followed by the UWB equipment user.[67 FR 34856, May 16, 2002, as amended at 68 FR 19751, Apr. 22, 2003]

Effective Date Note: At 68 FR 19751, Apr. 22, 2003, Sec. 15.525 was amended by revising [[Page 925]] paragraphs (b) and (e). This amendment contains information collection and recordkeeping requirements and will not become effective until approval has been given by the Office of Management and Budget.

FCC GROUND PENETRATING RADAR COORDINATION NOTICE

NAME:

ADDRESS:

CONTACT INFORMATION [CONTACT NAME AND PHONE NUMBER]:

AREA OF OPERATION [COUNTIES, STATES OR LARGER AREAS]:

FCC ID: QJQ-NG250

EQUIPMENT NOMENCLATURE: NG250

Send the information to:

Frequency Coordination Branch., OET

Federal Communications Commission

445 12th Street, SW

Washington, D.C. 20554

ATTN: UWB Coordination

Fax: 202-418-1944

INFORMATION PROVIDED IS DEEMED CONFIDENTIAL

B-2 ETSI Regulations for the EC (European Community)

In the European Community (EC), GPR instruments must conform to ETSI (European Technical Standards Institute) standard EN 302 066-1 v1.2.1. Details on individual country requirements for licensing are coordinated with this standard. For more information, contact Sensors & Software's technical staff.

All Sensors & Software ground penetrating radar (GPR) products offered for sale in European Community countries or countries adhering to ETSI standards are tested to comply with EN 302 066 v1.2.1.

For those who wish to get more detailed information, they should acquire copies of the following documents available from ETSI.

ETSI EN 302 066-1 V1.2.1 (February 2008) Electromagnetic compatibility and Radio spectrum Matters (ERM); Ground and Wall- Probing Radar applications (GPR/WPR) imaging systems; Part 1: Technical characteristics and test methods

ETSI EN 302 066-2 V1.2.1 (February 2008) Electromagnetic compatibility and Radio spectrum Matters (ERM); Ground and Wall- Probing Radar applications (GPR/WPR) imaging systems; Part 2: Harmonized EN covering essential requirements of article 3.2 of the R&TTE Directive

ETSI TR 101 994-2 V1.1.2 (March 2008) Electromagnetic compatibility and Radio spectrum Matters (ERM); Short Range Devices (SRD); Technical characteristics for SRD equipment using Ultra Wide Band technology (UWB); Part 2: Ground- and Wall- Probing Radar applications; System Reference Document

B-3a Industry Canada Regulations - English

Industry Canada published its regulations for ground penetrating radar (GPR) on Mar 29 2009 as part of the RSS-220 titled 'Devices Using Ultra-Wideband (UWB) Technology'.

Industry Canada has made a unique exception for GPR by not requiring user licensing. The user does have to comply with the following directives:

This Ground Penetrating Radar Device shall be operated only when in contact with or within 1 m of the ground.

This Ground Penetrating Radar Device shall be operated only by law enforcement agencies, scientific research institutes, commercial mining companies, construction companies, and emergency rescue or firefighting organizations.

Should the ground penetrating radar be used in a wall-penetrating mode then the following restriction should be noted by the user:

This In-wall Radar Imaging Device shall be operated where the device is directed at the wall and in contact with or within 20 cm of the wall surface.

This In-wall Radar Imaging Device shall be operated only by law enforcement agencies, scientific research institutes, commercial mining companies, construction companies, and emergency rescue or firefighting organizations.

Since operation of GPR is on a license-exempt basis, the user must accept the following:

Operation is subject to the following two conditions: (1) this device may not cause interference, and (2) this device must accept any interference, including interference that may cause undesired operation of the device.

B-3b Règlement d'Industrie Canada - Français

Industrie Canada a publié des règlements pour les appareils géoradar (GPR) le 29 mars 2009, dans le cadre du RSS-220 intitulé "Dispositifs utilisant la bande ultra-large (UWB)".

Industrie Canada a faite une exception unique pour GPR en n'exigeant pas de licence par utilisateur. L'utilisateur doit se conformer aux directives suivantes:

Ce géoradar périphérique doit être utilisé que lorsqu'il est en contact avec ou moins de 1 m du sol.

Ce géoradar périphérique doit être utilisé que par les organisations d'application de la loi, les instituts de recherche scientifique, des sociétés minières commerciales, entreprises de construction et de secours d'urgence ou des organisations de lutte contre les incendies.

Si le géoradar est utilisé dans un mode de pénétration au mur, la restriction suivante est à noter par l'utilisateur:

Ce dispositif d'imagerie radar doit être utilisé lorsque l'appareil est orienté vers le mur et en contact avec ou dans les 20 cm de la surface du mur.

Ce dispositif d'imagerie radar doit être utilisé que par les organisations d'application de la loi, les instituts de recherche scientifique, des sociétés minières commerciales, entreprises de construction et de secours d'urgence ou des organisations de lutte contre les incendies.

Parce que l'exploitation de GPR est sur une base exempte de licence, l'utilisateur doit accepter le texte suivant:

La fonctionnement est soumis aux deux conditions suivantes: (1) cet appareil ne peut pas provoquer d'interférences et (2) cet appareil doit accepter toute interférence, y compris les interférences qui peuvent causer un mauvais fonctionnement du dispositif

Appendix C: Instrument Interference

Immunity regulations place the onus on instrument/apparatus/device manufacturers to assure that extraneous interference will not unduly cause an instrument/apparatus/device to stop functioning or to function in a faulty manner.

Based on independent testing house measurements, Sensors & Software Inc. systems comply with such regulations in Canada, USA, European Community and most other jurisdictions. GPR devices can sense electromagnetic fields. External sources of electromagnetic fields such as TV stations, radio stations and cell phones, can cause signals detectable by a GPR which may degrade the quality of the data that a GPR device records and displays.

Such interference is unavoidable but sensible survey practice and operation by an experienced GPR practitioner can minimize such problems. In some geographic areas emissions from external sources may be so large as to preclude useful measurements. Such conditions are readily recognized and accepted by the professional geophysical community as a fundamental limitation of geophysical survey practice. Such interference being present in the GPR recordings is not considered as an equipment fault or as a failure to comply with immunity regulations.

Appendix D: Safety around Explosive Devices

Concerns are expressed from time to time on the hazard of GPR products being used near blasting caps and unexploded ordnance (UXO). Experience with blasting caps indicates that the power of Sensors & Software Inc.'s GPR products is not sufficient to trigger blasting caps. Based on a conservative independent testing house analysis, we recommend keeping the GPR transmitters at least 5 feet (2m) from blasting cap leads as a precaution. Some customers do experimental trials with their particular blasting devices to confirm with safety. We strongly recommend that GPR users routinely working with explosive devices develop a systematic safety methodology in their work areas.

The UXO issue is more complex and standards on fuses do not exist for obvious reasons. To date, no problems have been reported with any geophysical instrument used for UXO. Since proximity and vibration are also critical for UXO, the best advice is to be cautious and understand the risks.

Appendix E: Wi-Fi Module

FCC Notice:

NOTE: This equipment has been tested and found to comply with the limits for a Class A digital device, pursuant to part 15 of the FCC Rules. These limits are designed to provide reasonable protection against harmful interference when the equipment is operated in a commercial environment. This equipment generates, uses, and can radiate radio frequency energy and, if not installed and used in accordance with the instruction manual, may cause harmful interference to radio communications. Operation of this equipment in a residential area is likely to cause harmful interference in which case the user will be required to correct the interference at his/her own expense.

Industry Canada Notice:

This device complies with Industry Canada's license-exempt RSSs. Operation is subject to the following two conditions:

- (1) This device may not cause interference; and
- (2) This device must accept any interference, including interference that may cause undesired operation of the device.